

# DDR Termination Regulator

## General Description

RT9026 is a 3A sink/source tracking termination regulator. It is specifically designed for low-cost and low-external component count systems. The RT9026 possesses a high speed operating amplifier that provides fast load transient response and only requires 20μF of ceramic output capacitance. The RT9026 supports remote sensing functions and all features required to power the DDRI/II/III and low-power DDRIII/DDRIV VTT bus termination according to the JEDEC specification. In addition, the RT9026 includes integrated sleep-state controls placing VTT in High-Z in S3 (suspend to RAM) and soft-off for VTT and VTTREF in S5 (shutdown). The RT9026 is available in the thermal efficient package SOP-8 (Exposed Pad), MSOP-10 (Exposed Pad) and WDFN-10L 3x3.

## Applications

- | DDRI/II/III and Low-Power DDRIII/DDRIV Memory Termination
- | SSTL-2, SSTL-18
- | HSTL Termination

## Ordering Information

RT9026 □□

- Package Type
  - SP : SOP-8 (Exposed Pad-Option 1)
  - FP : MSOP-10 (Exposed Pad)
  - QW : WDFN-10L 3x3 (W-Type)
- Lead Plating System
  - P : Pb Free
  - G : Green (Halogen Free and Pb Free)

Note :

Richtek products are :

- } RoHS compliant and compatible with the current requirements of IPC/JEDEC J-STD-020.
- } Suitable for use in SnPb or Pb-free soldering processes.

## Features

- | Support DDRI, DDRII, DDRIII, Low-Power DDRIII and DDRIV Requirement
  - } Source/Sink 3A for DDRI and DDRII
  - } Source/Sink 2A for DDRIII
  - } Source/Sink 1.5A for Low-Power DDRIII
  - } Source/Sink 1.2A for Low-Power DDRIV
- | Input Voltage Range : 3.15V to 5.5V
- | VLDOIN Voltage Range : 1.2V to 3.3V
- | Requires Only 20μF Ceramic Output Capacitance
- | Supports High-Z in S3 and Soft-Off in S5
- | Integrated Divider Tracks 1/2 VDDQSNS for Both VTT and VTTREF
- | Remote Sensing (VTTSENS)
- | ±20mV Accuracy for VTT and VTTREF
- | 10mA Buffered Reference (Sourcing/Sinking) (VTTREF)
- | Built-In Soft-Start
- | Over Current Protection
- | Thermal Shutdown Protection
- | SOP-8 (Exposed Pad), MSOP-10 (Exposed Pad) and 10-Lead WDFN Package
- | RoHS Compliant and Halogen Free

## Pin Configurations

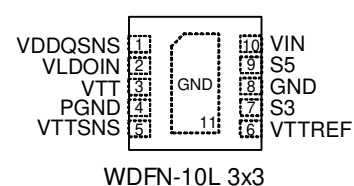
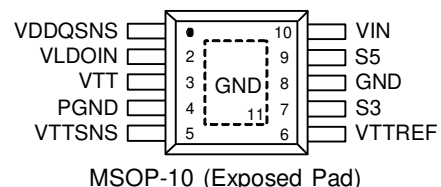
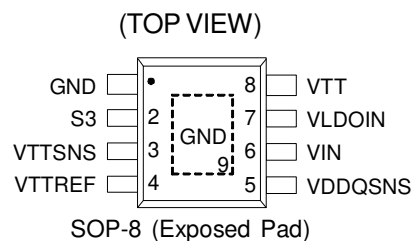

## Marking Information

RT9026PSP

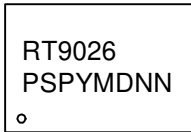

RT9026PSP : Product Code  
YMDNN : Date Code

RT9026PFP

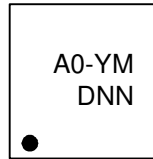

A0- : Product Code  
YMDNN : Date Code

RT9026GSP

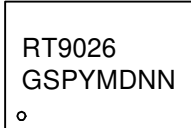

RT9026GSP : Product Code  
YMDNN : Date Code

RT9026GFP

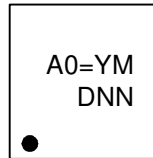

A0= : Product Code  
YMDNN : Date Code

RT9026PQW

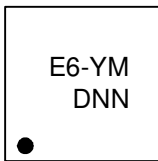

E6- : Product Code  
YMDNN : Date Code

RT9026GQW

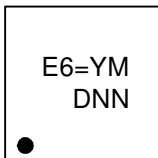

E6= : Product Code  
YMDNN : Date Code

## Typical Application Circuit

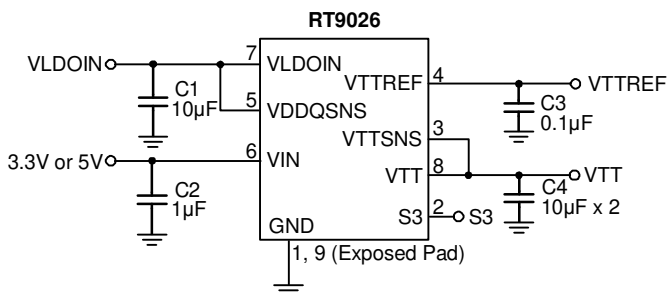

Figure 1. For SOP-8 (Exposed Pad) Package

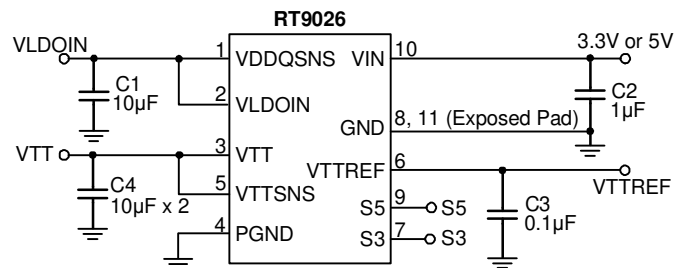

Figure 2. For MSOP-10 (Exposed Pad) / WDFN-10L 3x3 Package

## Functional Pin Description

| Pin No.               |                        | Pin Name | Pin Function  |
|-----------------------|------------------------|----------|---|
| RT9026□SP             | RT9026□FP<br>RT9026□QW |          |   |
| 1,<br>9 (Exposed Pad) | 8,<br>11 (Exposed Pad) | GND      | Ground. The exposed pad must be soldered to a large PCB and connected to GND for maximum power dissipation. |
| 2                     | 7                      | S3       | Active Low Suspend to RAM Mode Control Pin, VTT is turned off and left High-Z, VTTREF is active.            |
| 3                     | 5                      | VTTSENS  | VTT Voltage Sense Input Pin. Connect to plus terminal of the output capacitor.                              |

To be Continued

| Pin No.   |                        | Pin Name | Pin Function  |
|-----------|------------------------|----------|---|
| RT9026□SP | RT9026□FP<br>RT9026□QW |          |   |
| 4         | 6                      | VTTREF   | Buffered output that is a reference output, equal to VDDQSNS/2.                               |
| 5         | 1                      | VDDQSNS  | VLDOIN Sense Input Pin.   |
| 6         | 10                     | VIN      | Analog Input Pin (to control loop).   |
| 7         | 2                      | VLDOIN   | Power supply of the VTT and VTTREF output stage (to power MOS).                               |
| 8         | 3                      | VTT      | Output voltage for connection to termination resistors, equal to VDDQSNS/2.                   |
| --        | 4                      | PGND     | Power Ground of the VTT Output.   |
| --        | 9                      | S5       | Active low shutdown control pin, both VTT and VTTREF are turned off and discharged to ground. |

**Function Block Diagram**

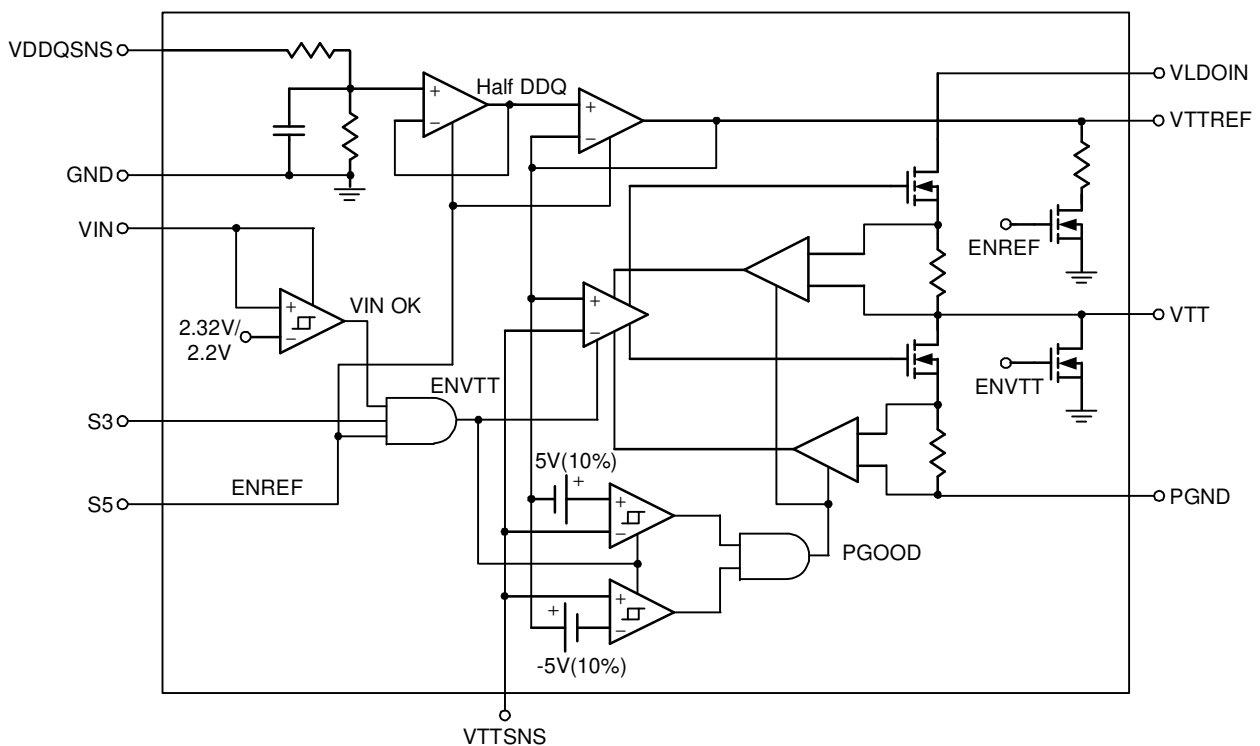

**Table 1. S3 and S5 Control Table**

| State           | S3   | S5   | VTT                              | VREF                             |
|-----------------|------|------|----------------------------------|----------------------------------|
| <b>Normal</b>   | High | High | 1.25V/0.9V/0.75V<br>/0.675V/0.6V | 1.25V/0.9V/0.75V<br>/0.675V/0.6V |
| <b>Standby</b>  | Low  | High | 12mV/6mV<br>(High-Z)             | 1.25V/0.9V/0.75V<br>/0.675V/0.6V |
| <b>Shutdown</b> | Low  | Low  | 0V (Discharge)                   | 0V (Discharge)                   |
| <b>Shutdown</b> | High | Low  | 0V (Discharge)                   | 0V (Discharge)                   |

## Absolute Maximum Ratings (Note 1)

|   |                |
|---|----------------|
| Supply Input Voltage, $V_{IN}$ -----              | 6V             |
| Supply Input Voltage, VLDOIN, VDDQSNS -----       | 3.6V           |
| Power Dissipation, $P_D @ T_A = 25^\circ\text{C}$ |                |
| SOP-8 (Exposed Pad) -----                         | 1.333W         |
| MSOP-10 (Exposed Pad) -----                       | 1.163W         |
| WDFN-10L 3x3 -----                                | 1.429W         |
| Package Thermal Resistance (Note 2)               |                |
| SOP-8 (Exposed Pad), $\theta_{JA}$ -----          | 75°C/W         |
| SOP-8 (Exposed Pad), $\theta_{JC}$ -----          | 28°C/W         |
| MSOP-10 (Exposed Pad), $\theta_{JA}$ -----        | 86°C/W         |
| MSOP-10 (Exposed Pad), $\theta_{JC}$ -----        | 30°C/W         |
| WDFN-10L 3x3, $\theta_{JA}$ -----                 | 70°C/W         |
| WDFN-10L 3x3, $\theta_{JC}$ -----                 | 8.2°C/W        |
| Lead Temperature (Soldering, 10 sec.) -----       | 260°C          |
| Junction Temperature -----                        | 150°C          |
| Storage Temperature Range -----                   | -65°C to 150°C |
| ESD Susceptibility (Note 3)                       |                |
| HBM (Human Body Mode) -----                       | 2kV            |
| MM (Machine Mode) -----                           | 200V           |

## Recommended Operating Conditions (Note 4)

|   |                |
|---|----------------|
| Supply Input Voltage, $V_{IN}$ -----        | 3.15V to 5.5V  |
| Supply Input Voltage, VLDOIN, VDDQSNS ----- | 1.2V to 3.3V   |
| Junction Temperature Range -----            | -40°C to 125°C |
| Ambient Temperature Range -----             | -40°C to 85°C  |

## Electrical Characteristics

( $V_{IN} = 5V$ , VLDOIN = VDDQSNS = 2.5V, C1=10 $\mu$ F, C2=1 $\mu$ F, C3=0.1 $\mu$ F, C4=10 $\mu$ Fx2,  $T_A = 25^\circ\text{C}$ , S5 function only for RT9026PFP and RT9026PQW, unless otherwise specified)

| Parameter                                 | Symbol           | Test Conditions   | Min | Typ  | Max | Unit    |
|---|------------------|---|-----|------|-----|---------|
| $V_{IN}$ (to control loop) Supply Current | $I_{VIN}$        | $V_{IN} = 5V$ , No Load, S5 = S3 = 5V                                       | --  | --   | 2   | mA      |
| $V_{IN}$ Standby Current                  | $I_{VINSTB}$     | $V_{IN} = 5V$ , No Load, S5 = 5V, S3 = 0V                                   | --  | --   | 300 | $\mu$ A |
| $V_{IN}$ Shutdown Current                 | $I_{VINSHDN}$    | $V_{IN} = 5V$ , No Load, S5 = S3 = 0V<br>(Only for RT9026PFP and RT9026PQW) | --  | --   | 1   | $\mu$ A |
| VLDOIN (to power MOS) Supply Current      | $I_{VLDOIN}$     | $V_{IN} = 5V$ , No Load, S5 = S3 = 5V                                       | --  | --   | 2   | mA      |
| VLDOIN Standby Current                    | $I_{VLDOINSTB}$  | $V_{IN} = 5V$ , No Load, S5 = 5V, S3 = 0V                                   | --  | --   | 10  | $\mu$ A |
| VLDOIN Shutdown Current                   | $I_{VLDOINSHDN}$ | $V_{IN} = 5V$ , No Load, S5 = S3 = 0V                                       | --  | --   | 1   | $\mu$ A |
| VDDQSNS Input Current                     | $I_{VDDQSNS}$    | $V_{IN} = 5V$ , S5 = S3 = 5V  | --  | --   | 50  | $\mu$ A |
| VTT SNS Input Current                     | $I_{VTT SNS}$    | $V_{IN} = 5V$ , S5 = S3 = 5V  | --  | --   | 1   | $\mu$ A |
| VTT Output Voltage                        | VTT              | VDDQSNS = VLDOIN = 2.5V   | --  | 1.25 | --  | V       |
|   |                  | VDDQSNS = VLDOIN = 1.8V   | --  | 0.9  | --  |         |
|   |                  | VDDQSNS = VLDOIN = 1.5V   | --  | 0.75 | --  |         |

To be Continued

| Parameter                                  | Symbol                 | Test Conditions  | Min        | Typ                             | Max | Unit |
|--|------------------------|--|------------|---------------------------------|-----|------|
| VTT Output Voltage                         | VTT                    | VDDQSNS = VLDOIN = 1.35V   | --         | 0.675                           | --  | V    |
|  |                        | VDDQSNS = VLDOIN = 1.2V  | --         | 0.6                             | --  |      |
| VTTREF, VTT Output Tolerance               | V <sub>VTTTOL</sub>    | VDDQSNS = VLDOIN = 2.5V/1.8V/1.5V/1.35V/1.2V,  I <sub>VTT</sub>   = 0A   | -20        | --                              | 20  | mV   |
|  |                        | VDDQSNS = VLDOIN = 1.2V,  I <sub>VTT</sub>   = 1.2A                      | -40        | --                              | 40  |      |
|  |                        | VDDQSNS = VLDOIN = 2.5V/1.8V/1.5V/1.35V,  I <sub>VTT</sub>   = 1.5A      | -40        | --                              | 40  |      |
|  |                        | VDDQSNS = VLDOIN = 2.5V/1.8V,  I <sub>VTT</sub>   = 3A                   | -40        | --                              | 40  |      |
| VTT Source Current Limit                   | I <sub>VTTOCLsr</sub>  | VTT = 0V   | 3          | 4                               | --  | A    |
| VTT Sink Current Limit                     | I <sub>VTTOCLsk</sub>  | VTT = VDDQSNS  | 3          | 4                               | --  | A    |
| VTT Discharge Current                      | I <sub>DSCHRG</sub>    | VDDQSNS = 0V, VTT = 1.25V, S5 = S3 = 0V                                  | 10         | 17                              | --  | mA   |
| VTTREF Output Voltage                      | V <sub>VTTREF</sub>    | $V_{VTTREF} = \left( \frac{V_{VDDQSNS}}{2} \right)$                      | --         | 1.25/0.9/<br>0.75/<br>0.675/0.6 | --  | V    |
| VDDQSNS/2, VTTREF Output Voltage Tolerance | V <sub>VTTREFTOL</sub> | VLDOIN = VDDQSNS = 2.5V/1.8V/1.5V/1.35V/1.2V, I <sub>VTTREF</sub> < 10mA | -20        | --                              | 20  | mV   |
| VTTREF Source Current Limit                | I <sub>VTTREFOCL</sub> | V <sub>VTTREF</sub> = 0V   | 20         | 40                              | 60  | mA   |
| UVLO Threshold Voltage                     | V <sub>UVLO</sub>      | Rising   | --         | --                              | 2.7 | V    |
|  |                        | Hysteresis   | --         | 0.2                             | --  |      |
| Input Voltage                              | Logic-High             | V <sub>IH</sub>  | S5, S3 pin | 1.6                             | --  | V    |
|  | Logic-Low              | V <sub>IL</sub>  | S5, S3 pin | --                              | --  |      |
| Logic Input Leakage Current                | I <sub>IILK</sub>      | S5, S3 pin   | --         | --                              | 1   | μA   |
| Thermal Shutdown Protection                | T <sub>SD</sub>        |  | --         | 160                             | --  | °C   |
| Thermal Shutdown Hysteresis                | ΔT <sub>SD</sub>       |  | --         | 20                              | --  | °C   |

**Note 1.** Stresses listed as the above "Absolute Maximum Ratings" may cause permanent damage to the device. These are for stress ratings. Functional operation of the device at these or any other conditions beyond those indicated in the operational sections of the specifications is not implied. Exposure to absolute maximum rating conditions for extended periods may remain possibility to affect device reliability.

**Note 2.** θ<sub>JA</sub> is measured in the natural convection at T<sub>A</sub> = 25°C on a high effective four-layers thermal conductivity test board of JEDEC 51-7 thermal measurement standard. The case point of θ<sub>JC</sub> is on the exposed pad for SOP-8 (Exposed Pad), MSOP-10 (Exposed Pad) and WDFN-10L 3x3 package.

**Note 3.** Devices are ESD sensitive. Handling precaution is recommended.

**Note 4.** The device is not guaranteed to function outside its operating conditions.

## Typical Operating Characteristics

$V_{DDQSN5} = V_{LDOIN}$ ,  $C1 = 10\mu F$ ,  $C2 = 1\mu F$ ,  $C3 = 0.1\mu F$ ,  $C4 = 10\mu F \times 2$  unless otherwise specified.

### 1.25V<sub>TT</sub> Output Voltage vs. Temperature

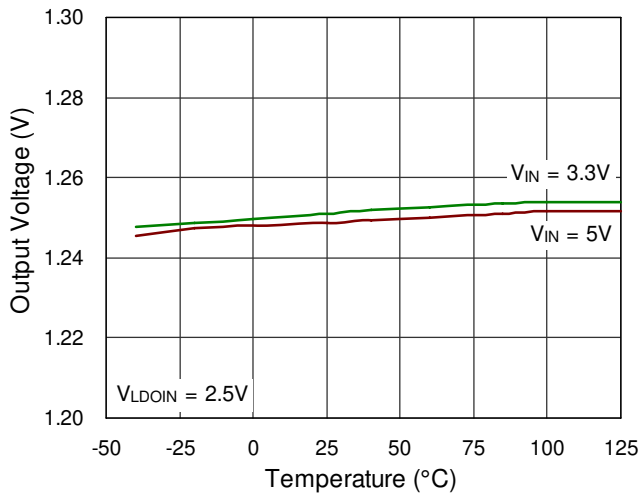

### 0.9V<sub>TT</sub> Output Voltage vs. Temperature

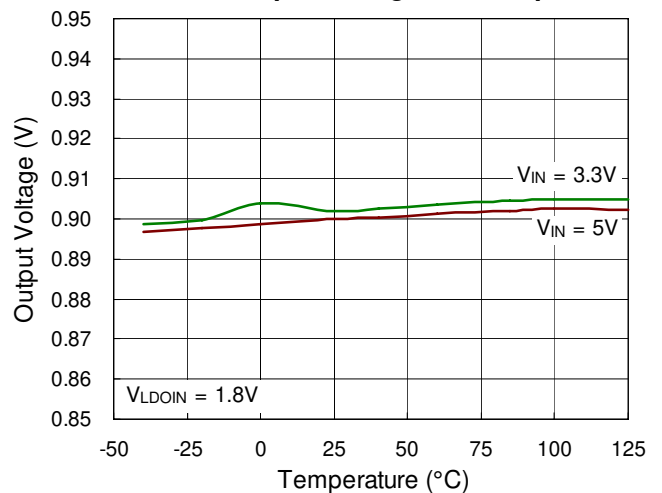

### 0.75V<sub>TT</sub> Output Voltage vs. Temperature

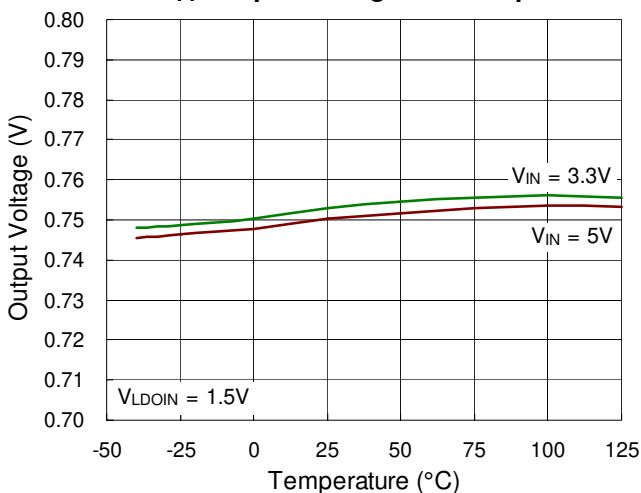

### 0.675V<sub>TT</sub> Output Voltage vs. Temperature

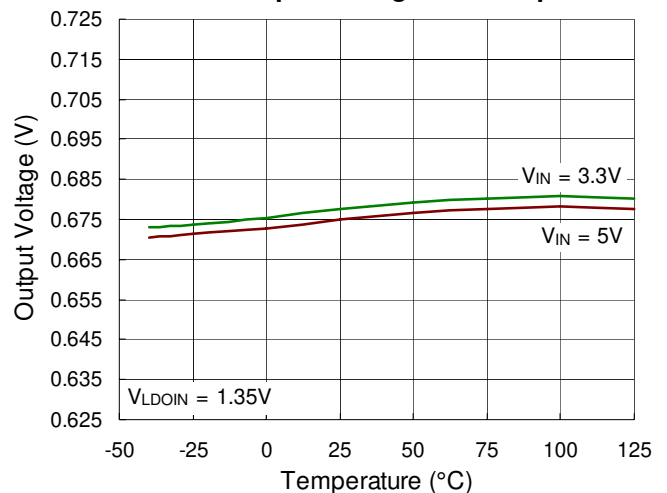

### 0.6V<sub>TT</sub> Output Voltage vs. Temperature

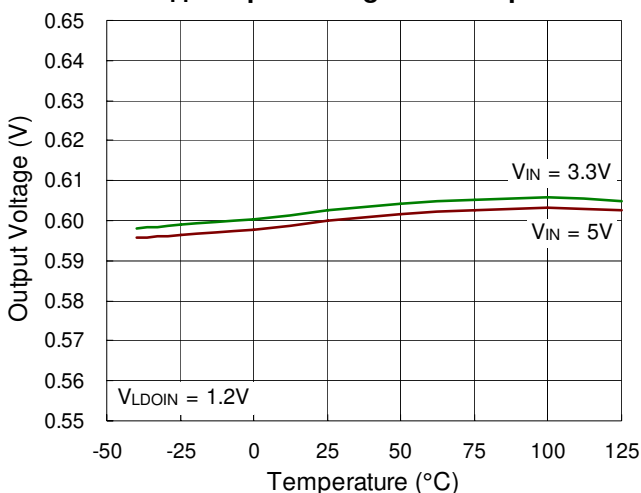

### V<sub>IN</sub> Supply Current vs. Temperature

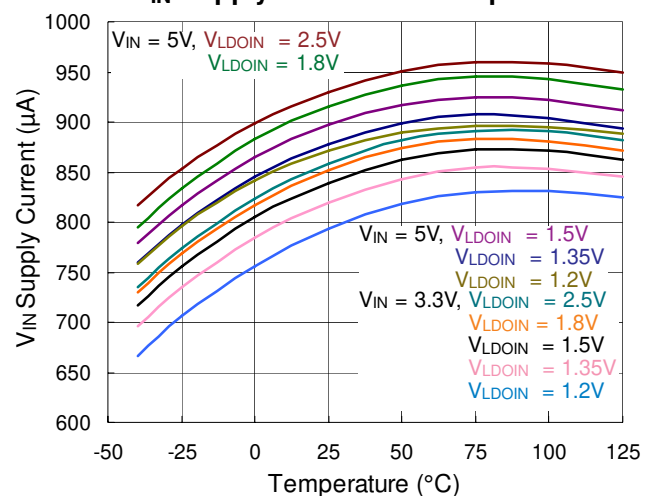

**V<sub>IN</sub> Standby Current vs. Temperature**

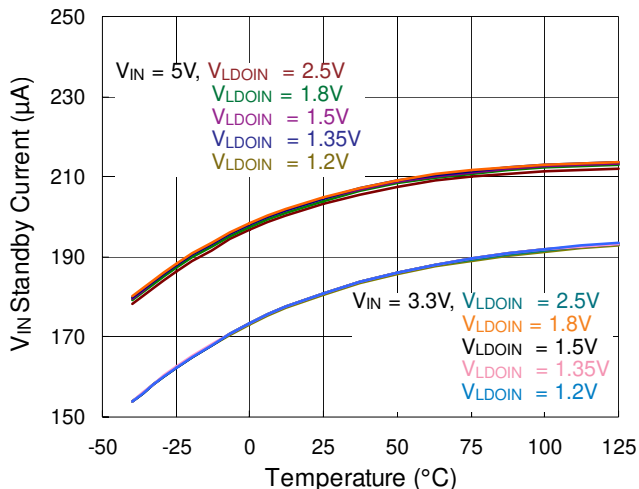

**1.25V<sub>TT</sub> @ 3A Transient Response**

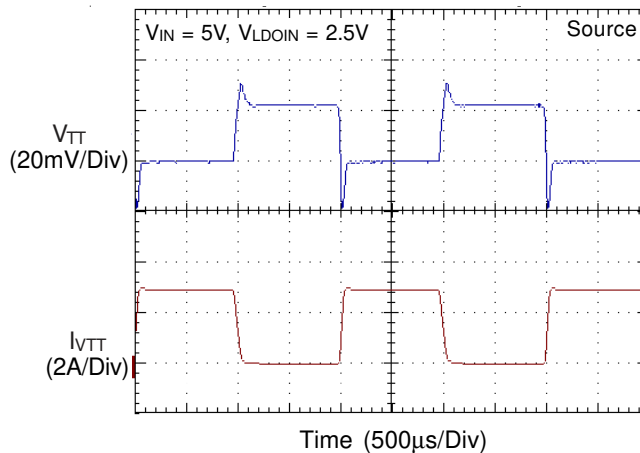

**0.9V<sub>TT</sub> @ 3A Transient Response**

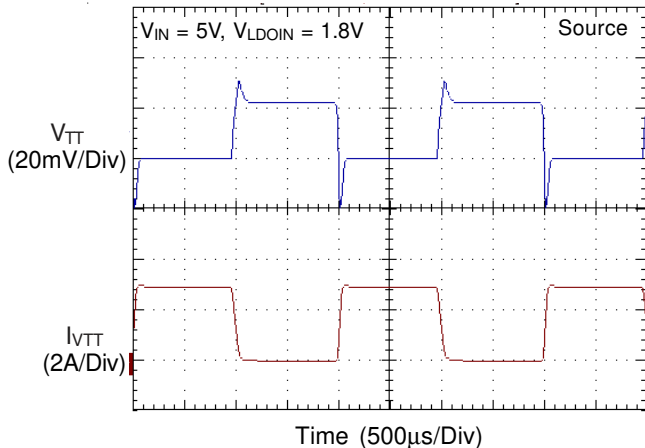

**0.75V<sub>TT</sub> @ 2A Transient Response**

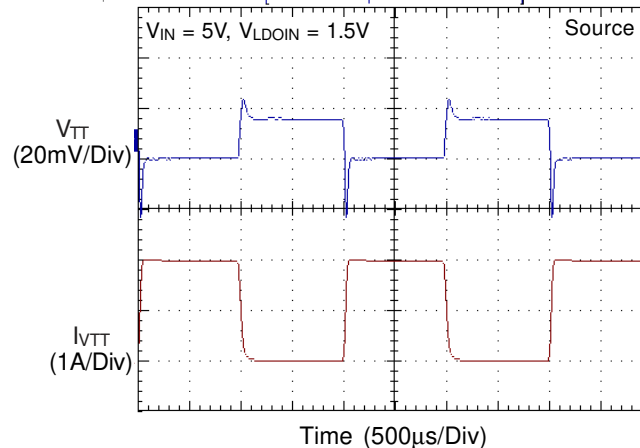

**0.675V<sub>TT</sub> @ 1.5A Transient Response**

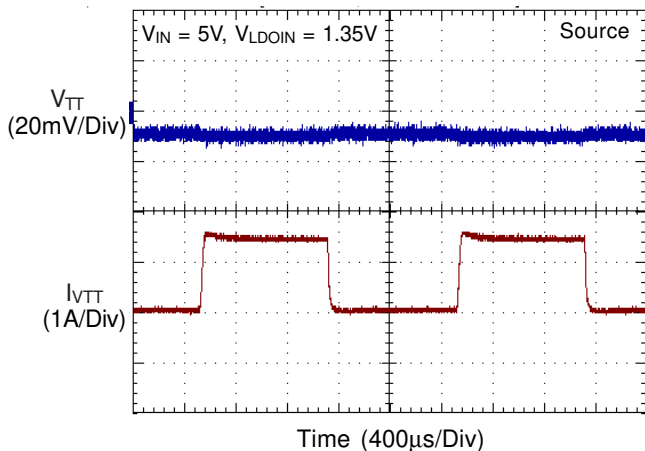

**0.6V<sub>TT</sub> @ 1.2A Transient Response**

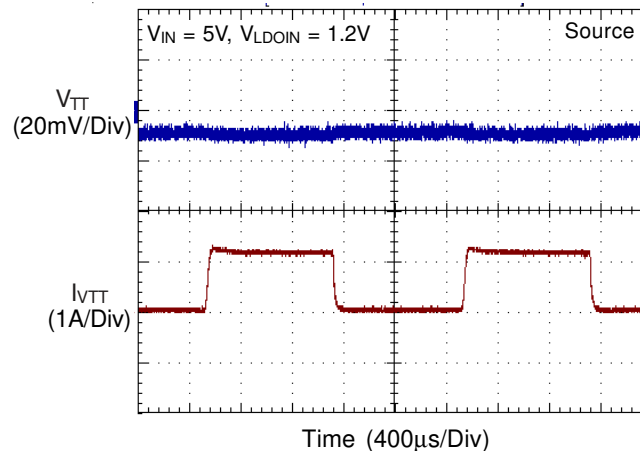

1.25V<sub>TT</sub> @ 3A Transient Response

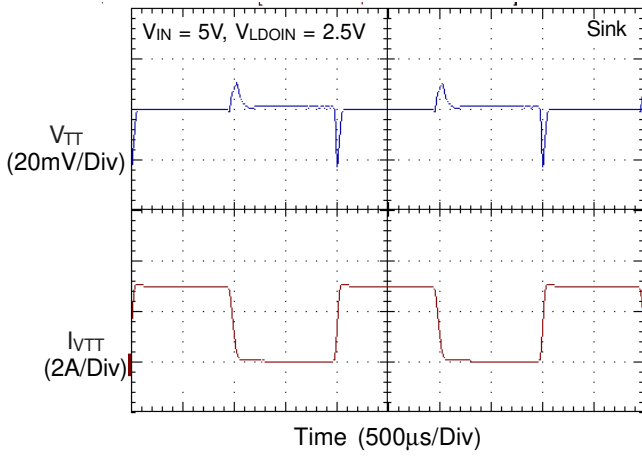

0.9V<sub>TT</sub> @ 3A Transient Response

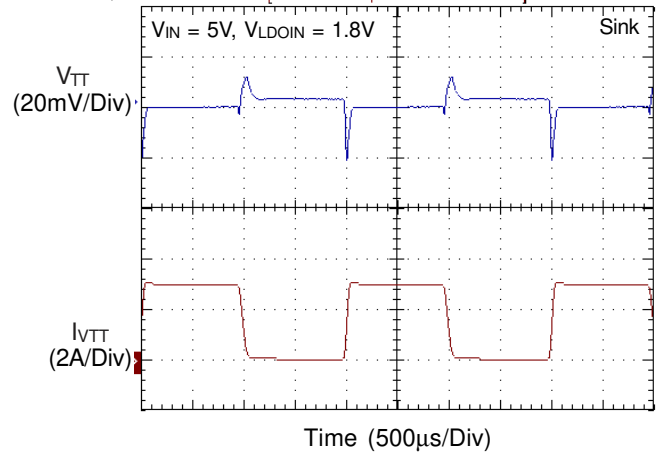

0.75V<sub>TT</sub> @ 2A Transient Response

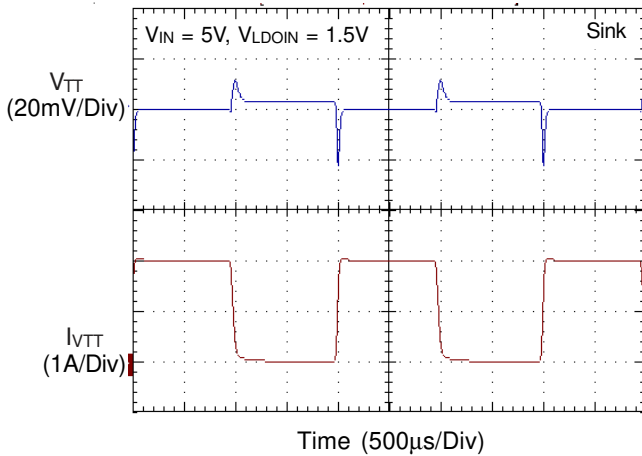

0.675V<sub>TT</sub> @ 1.5A Transient Response

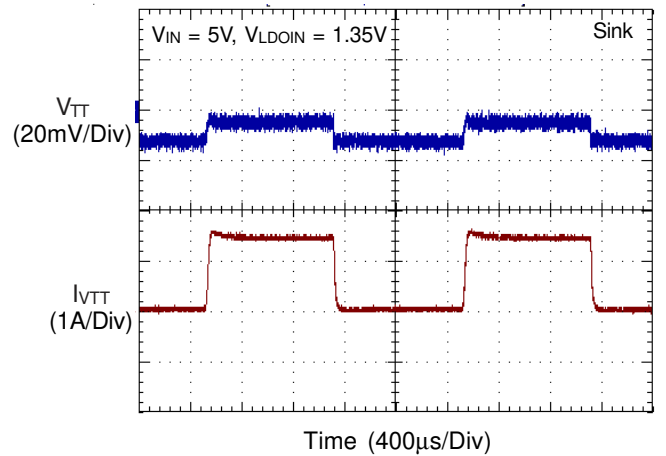

0.6V<sub>TTREF</sub> @ 1.2A Transient Response

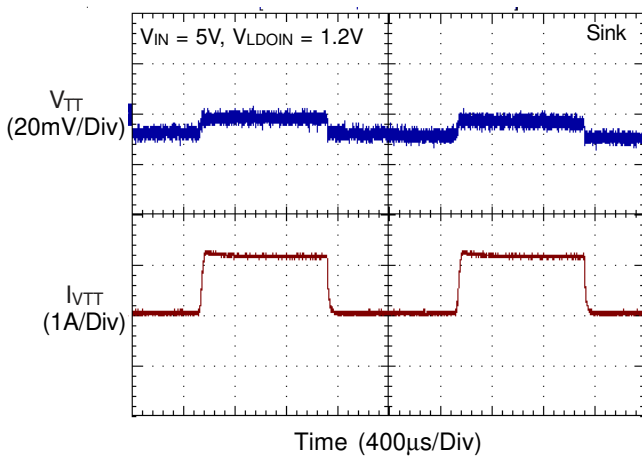

0.9V<sub>TTREF</sub> @ 10mA Transient Response

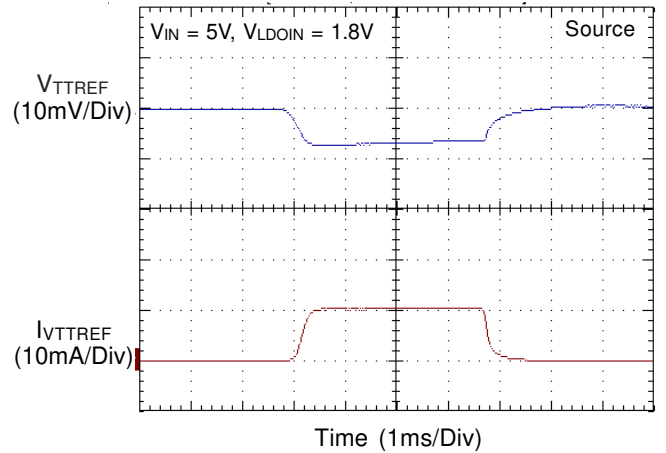



0.9V<sub>TTREF</sub> @ 10mA Transient Response

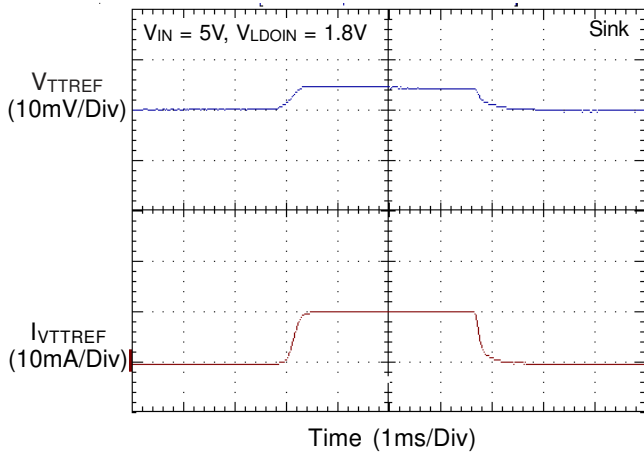

Start Up

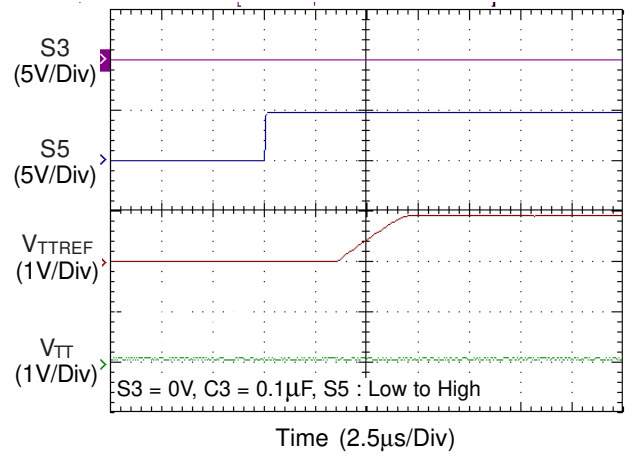

Start Up

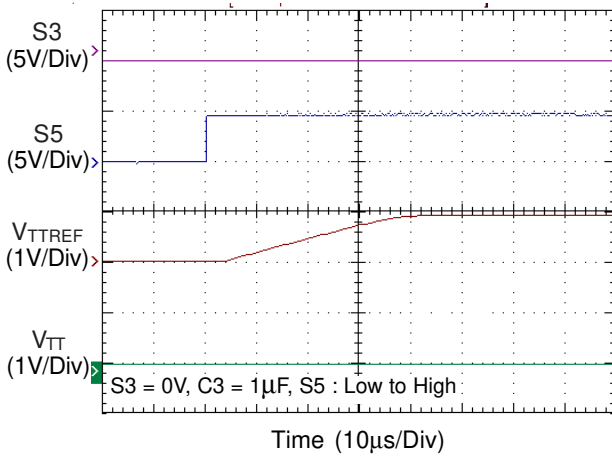

Start Up

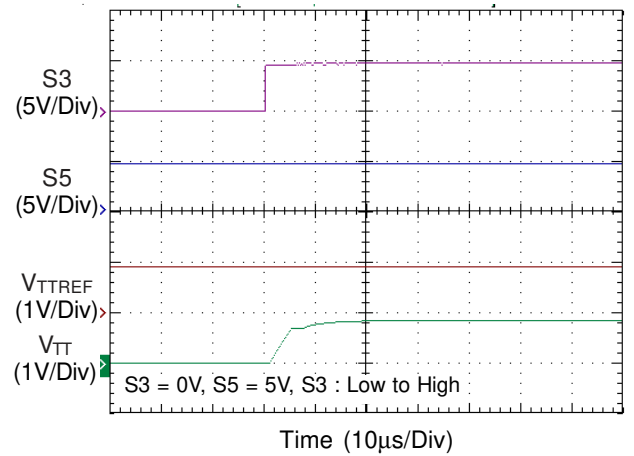

Power Off

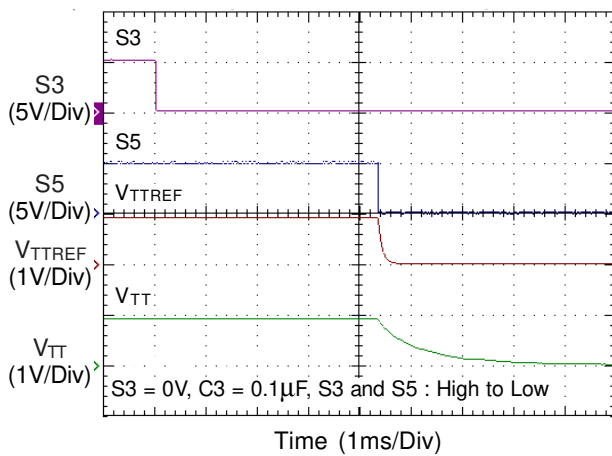

## Application Information

RT9026 is a 3A sink/source tracking termination regulator. It is specifically designed for low-cost and low-external component count system such as notebook PC applications. The RT9026 possesses a high speed operating amplifier that provides fast load transient response and only requires a 10μF ceramic input capacitor and two 10μF ceramic output capacitor.

### VTTREF Regulator

VTTREF is a reference output voltage with source/sink current capability up to 10mA. To ensure stable operation 0.1μF ceramic capacitor between VTTREF and GND is recommended.

### S3, S5 Logic Control

The S3 and S5 terminals should be connected to SLP\_S3 and SLP\_S5 signals respectively. Both VTTREF and VTT are turned on at normal state (S3 = High, S5 = High). In standby state (S3 = Low, S5 = High) VTTREF is kept alive while VTT is turned off and left high impedance. Both VTT and VTTREF outputs are turned off and discharged to ground through internal MOSFETs during shutdown state (S5 = low).

**Table 2. S3 and S5 Control**

| STATE    | S3 | S5 | VTTREF          | VTT             |
|----------|----|----|-----------------|-----------------|
| Normal   | H  | H  | ON              | ON              |
| Standby  | L  | H  | ON              | OFF(high-Z)     |
| Shutdown | L  | L  | OFF (discharge) | OFF (discharge) |

### Capacitor Selection

Good bypassing is recommended from VLDOIN to GND to help improve AC performance. A 10μF or greater input capacitor located as close as possible to the IC is recommended. The input capacitor must be located at a distance of less than 0.5 inches from the VLDOIN pin of the IC.

Adding a ceramic capacitor 1μF close to the VIN pin and it should be kept away from any parasitic impedance from the supply power.

For stable operation, the total capacitance of the ceramic capacitor at the VTT output terminal must not be larger than 30μF. The RT9026 is designed specifically to work with low ESR ceramic output capacitor in space saving and performance consideration. Larger output capacitance can reduce the noise and improve load transient response, stability and PSRR. The output capacitor should be located near the VTT output terminal pin as close as possible.

### Thermal Considerations

For continuous operation, do not exceed absolute maximum operation junction temperature. The maximum power dissipation depends on the thermal resistance of IC package, PCB layout, the rate of surroundings airflow and temperature difference between junction to ambient. The maximum power dissipation can be calculated by following formula :

$$P_{D(MAX)} = (T_{J(MAX)} - T_A) / \theta_{JA}$$

Where  $T_{J(MAX)}$  is the maximum operation junction temperature,  $T_A$  is the ambient temperature and the  $\theta_{JA}$  is the junction to ambient thermal resistance.

For recommended operating conditions specification of the RT9026, the maximum junction temperature is 125°C. The junction to ambient thermal resistance  $\theta_{JA}$  is layout dependent. The thermal resistance  $\theta_{JA}$  for WDFN-10L 3x3 is 70°C/W, for SOP-8 (Exposed Pad) is 75°C/W and for MSOP-10 (Exposed Pad) is 86°C/W on the standard JEDEC 51-7 four layers thermal test board. The maximum power dissipation at  $T_A = 25^\circ\text{C}$  can be calculated by following formula :

$$P_{D(MAX)} = (125^\circ\text{C} - 25^\circ\text{C}) / (70^\circ\text{C/W}) = 1.429\text{W for WDFN-10L 3x3 packages}$$

$$P_{D(MAX)} = (125^\circ\text{C} - 25^\circ\text{C}) / (75^\circ\text{C/W}) = 1.333\text{W for SOP-8 (Exposed Pad) packages}$$

$$P_{D(MAX)} = (125^\circ\text{C} - 25^\circ\text{C}) / (86^\circ\text{C/W}) = 1.163\text{W for MSOP-10 (Exposed Pad) packages}$$

The maximum power dissipation depends on operating ambient temperature for fixed  $T_{J(MAX)}$  and thermal resistance  $\theta_{JA}$ . For RT9026 packages, the Figure 3 of derating curves allows the designer to see the effect of rising ambient temperature on the maximum power allowed.

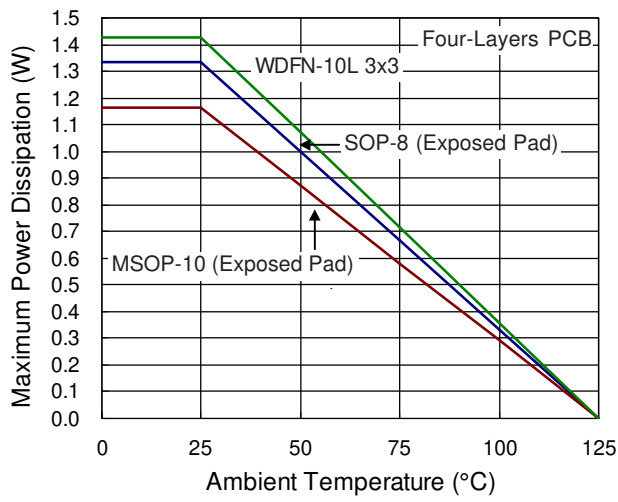
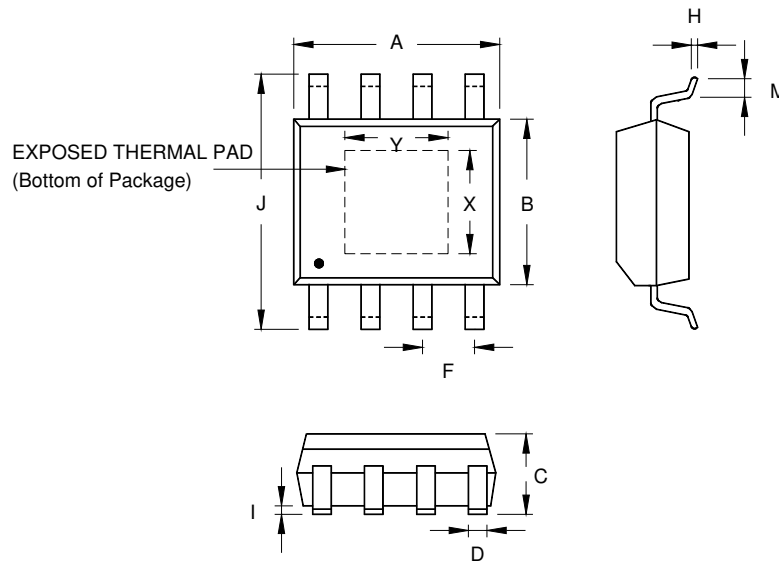

Figure 3. Derating Curves for the RT9026 Packages

Outline Dimension



| Symbol   | Dimensions In Millimeters |       | Dimensions In Inches |       |       |
|----------|---------------------------|-------|----------------------|-------|-------|
|          | Min                       | Max   | Min                  | Max   |       |
| A        | 4.801                     | 5.004 | 0.189                | 0.197 |       |
| B        | 3.810                     | 4.000 | 0.150                | 0.157 |       |
| C        | 1.346                     | 1.753 | 0.053                | 0.069 |       |
| D        | 0.330                     | 0.510 | 0.013                | 0.020 |       |
| F        | 1.194                     | 1.346 | 0.047                | 0.053 |       |
| H        | 0.170                     | 0.254 | 0.007                | 0.010 |       |
| I        | 0.000                     | 0.152 | 0.000                | 0.006 |       |
| J        | 5.791                     | 6.200 | 0.228                | 0.244 |       |
| M        | 0.406                     | 1.270 | 0.016                | 0.050 |       |
| Option 1 | X                         | 2.000 | 2.300                | 0.079 | 0.091 |
|          | Y                         | 2.000 | 2.300                | 0.079 | 0.091 |
| Option 2 | X                         | 2.100 | 2.500                | 0.083 | 0.098 |
|          | Y                         | 3.000 | 3.500                | 0.118 | 0.138 |

8-Lead SOP (Exposed Pad) Plastic Package

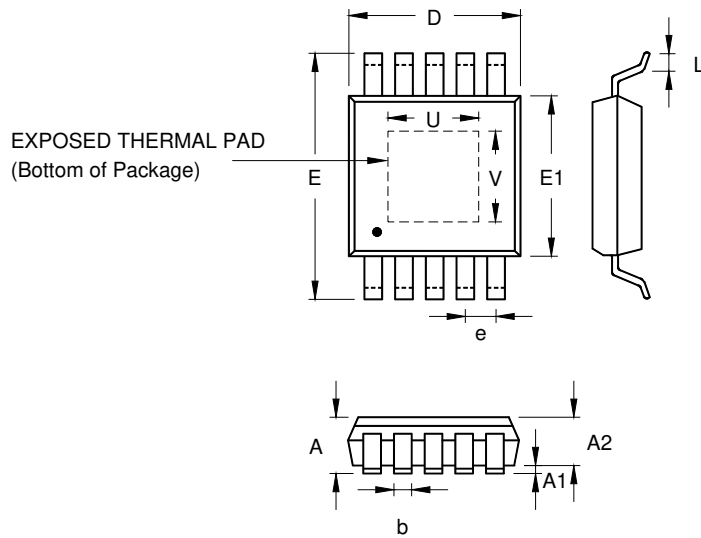

| Symbol | Dimensions In Millimeters |       | Dimensions In Inches |       |
|--------|---------------------------|-------|----------------------|-------|
|        | Min                       | Max   | Min                  | Max   |
| A      | 0.810                     | 1.100 | 0.032                | 0.043 |
| A1     | 0.000                     | 0.100 | 0.000                | 0.004 |
| A2     | 0.750                     | 0.950 | 0.030                | 0.037 |
| b      | 0.170                     | 0.270 | 0.007                | 0.011 |
| D      | 2.900                     | 3.100 | 0.114                | 0.122 |
| e      | 0.500                     |       | 0.020                |       |
| E      | 4.800                     | 5.000 | 0.189                | 0.197 |
| E1     | 2.900                     | 3.100 | 0.114                | 0.122 |
| L      | 0.400                     | 0.800 | 0.016                | 0.031 |
| U      | 1.300                     | 1.700 | 0.051                | 0.067 |
| V      | 1.500                     | 1.900 | 0.059                | 0.075 |

**10-Lead MSOP (Exposed Pad) Plastic Package**

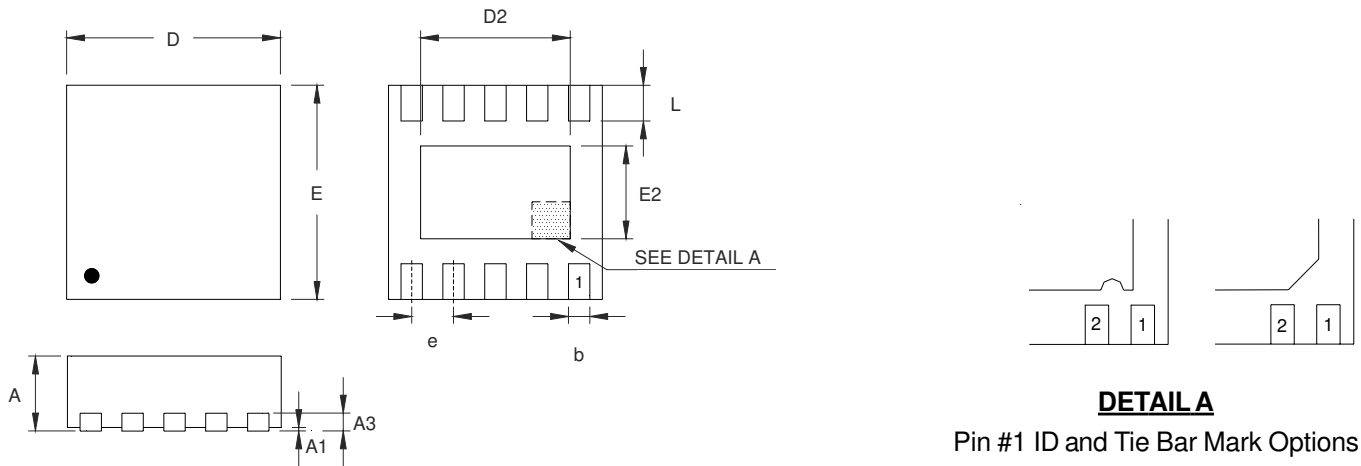

Note : The configuration of the Pin #1 identifier is optional, but must be located within the zone indicated.

| Symbol | Dimensions In Millimeters |       | Dimensions In Inches |       |
|--------|---------------------------|-------|----------------------|-------|
|        | Min                       | Max   | Min                  | Max   |
| A      | 0.700                     | 0.800 | 0.028                | 0.031 |
| A1     | 0.000                     | 0.050 | 0.000                | 0.002 |
| A3     | 0.175                     | 0.250 | 0.007                | 0.010 |
| b      | 0.180                     | 0.300 | 0.007                | 0.012 |
| D      | 2.950                     | 3.050 | 0.116                | 0.120 |
| D2     | 2.300                     | 2.650 | 0.091                | 0.104 |
| E      | 2.950                     | 3.050 | 0.116                | 0.120 |
| E2     | 1.500                     | 1.750 | 0.059                | 0.069 |
| e      | 0.500                     |       | 0.020                |       |
| L      | 0.350                     | 0.450 | 0.014                | 0.018 |

W-Type 10L DFN 3x3 Package

**Richtek Technology Corporation**

Headquarter  
 5F, No. 20, Taiyuen Street, Chupei City  
 Hsinchu, Taiwan, R.O.C.  
 Tel: (8863)5526789 Fax: (8863)5526611

**Richtek Technology Corporation**

Taipei Office (Marketing)  
 5F, No. 95, Minchiuan Road, Hsintien City  
 Taipei County, Taiwan, R.O.C.  
 Tel: (8862)86672399 Fax: (8862)86672377  
 Email: marketing@richtek.com

Information that is provided by Richtek Technology Corporation is believed to be accurate and reliable. Richtek reserves the right to make any change in circuit design, specification or other related things if necessary without notice at any time. No third party intellectual property infringement of the applications should be guaranteed by users when integrating Richtek products into any application. No legal responsibility for any said applications is assumed by Richtek.