

FMC7G30US60

Compact & Complex Module

General Description

Fairchild's Insulated Gate Bipolar Transistor (IGBT) power modules provide low conduction and switching losses as well as short circuit ruggedness. They are designed for applications such as motor control, uninterrupted power supplies (UPS) and general inverters where short circuit ruggedness is a required feature.

Features

- UL Certified No. E209204
- Short circuit rated 10us @ $T_C = 100^\circ\text{C}$, $V_{GE} = 15\text{V}$
- High speed switching
- Low saturation voltage : $V_{CE}(\text{sat}) = 2.2\text{V}$ @ $I_C = 30\text{A}$
- High input impedance
- Built in brake and 3 phase rectifier circuit
- Fast & soft anti-parallel FWD

Applications

- AC & DC motor controls
- General purpose inverters
- Robotics
- Servo controls

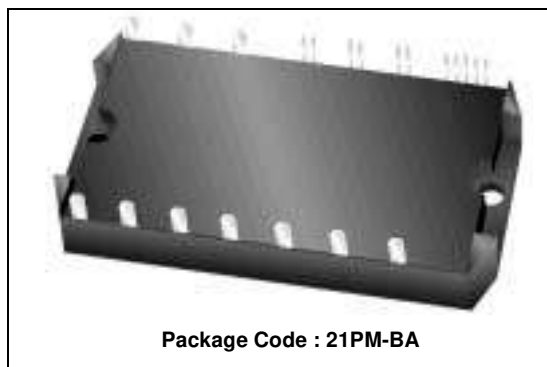

Package Code : 21PM-BA

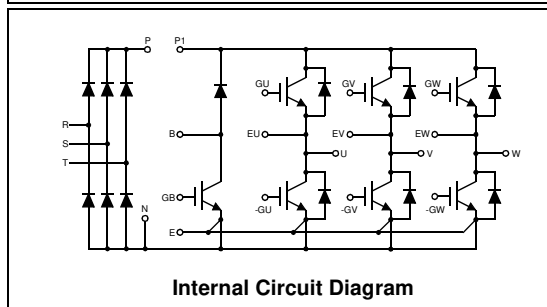

Internal Circuit Diagram

Absolute Maximum Ratings $T_C = 25^\circ\text{C}$ unless otherwise noted

	Symbol	Description	FMC7G30US60	Units
Inverter & Brake	V_{CES}	Collector-Emitter Voltage	600	V
	V_{GES}	Gate-Emitter Voltage	± 20	V
	I_C	Collector Current @ $T_C = 25^\circ\text{C}$	30	A
	$I_{CM(1)}$	Pulsed Collector Current	60	A
	I_F	Diode Continuous Forward Current @ $T_C = 100^\circ\text{C}$	30	A
	I_{FM}	Diode Maximum Forward Current	60	A
	P_D	Maximum Power Dissipation @ $T_C = 25^\circ\text{C}$	125	W
Converter	T_{SC}	Short Circuit Withstand Time @ $T_C = 100^\circ\text{C}$	10	us
	V_{RRM}	Repetitive Peak Reverse Voltage	1200	V
	I_O	Average Output Rectified Current	30	A
	I_{FSM}	Surge Forward Current @ 1Cycle at 60Hz, Peak value Non-Repetitive	300	A
Common	I^2t	1 Cycle Surge Current	369	A^2s
	T_J	Operating Junction Temperature	-40 to +150	$^\circ\text{C}$
	T_{STG}	Storage Temperature Range	-40 to +125	$^\circ\text{C}$
Mounting Torque	V_{ISO}	Isolation Voltage @ AC 1minute	2500	V
		Mounting part Screw @ M4	1.25	N.m

Notes :

(1) Repetitive rating : Pulse width limited by max. junction temperature

Electrical Characteristics of the IGBT @ Inverter & Brake $T_C = 25^\circ\text{C}$ unless otherwise noted

Symbol	Parameter	Test Conditions	Min.	Typ.	Max.	Units
Off Characteristics						
BV_{CES}	Collector-Emitter Breakdown Voltage	$V_{GE} = 0V, I_C = 250\mu A$	600	--	--	V
$\Delta BV_{CES}/\Delta T_J$	Temperature Coeff. of Breakdown Voltage	$V_{GE} = 0V, I_C = 1mA$	--	0.6	--	V/ $^\circ\text{C}$
I_{CES}	Collector Cut-Off Current	$V_{CE} = V_{CES}, V_{GE} = 0V$	--	--	250	μA
I_{GES}	G-E Leakage Current	$V_{GE} = V_{GES}, V_{CE} = 0V$	--	--	± 100	nA

On Characteristics						
$V_{GE(th)}$	G-E Threshold Voltage	$I_C = 30mA, V_{CE} = V_{GE}$	5.0	6.0	8.5	V
$V_{CE(sat)}$	Collector to Emitter Saturation Voltage	$I_C = 30A, V_{GE} = 15V$	--	2.2	2.8	V

Dynamic Characteristics						
C_{ies}	Input Capacitance	$V_{CE} = 30V, V_{GE} = 0V,$ $f = 1MHz$	--	1970	--	pF
C_{oes}	Output Capacitance		--	310	--	pF
C_{res}	Reverse Transfer Capacitance		--	74	--	pF

Switching Characteristics						
$t_{d(on)}$	Turn-On Delay Time	$V_{CC} = 300V, I_C = 30A,$ $R_G = 7\Omega, V_{GE} = 15V,$ Inductive Load, $T_C = 25^\circ\text{C}$	--	30	--	ns
t_r	Rise Time		--	65	--	ns
$t_{d(off)}$	Turn-Off Delay Time		--	54	80	ns
t_f	Fall Time		--	138	200	ns
E_{on}	Turn-On Switching Loss		--	0.92	--	mJ
E_{off}	Turn-Off Switching Loss		--	0.82	--	mJ
E_{ts}	Total Switching Loss	--	1.74	2.4	mJ	
$t_{d(on)}$	Turn-On Delay Time	$V_{CC} = 300V, I_C = 30A,$ $R_G = 7\Omega, V_{GE} = 15V,$ Inductive Load, $T_C = 125^\circ\text{C}$	--	34	--	ns
t_r	Rise Time		--	67	--	ns
$t_{d(off)}$	Turn-Off Delay Time		--	60	90	ns
t_f	Fall Time		--	281	400	ns
E_{on}	Turn-On Switching Loss		--	0.93	--	mJ
E_{off}	Turn-Off Switching Loss		--	1.56	--	mJ
E_{ts}	Total Switching Loss	--	2.49	3.4	mJ	
T_{sc}	Short Circuit Withstand Time	$V_{CC} = 300V, V_{GE} = 15V$ @ $T_C = 100^\circ\text{C}$	10	--	--	μs
Q_g	Total Gate Charge	$V_{CE} = 300V, I_C = 30A,$ $V_{GE} = 15V$	--	85	120	nC
Q_{ge}	Gate-Emitter Charge		--	17	25	nC
Q_{gc}	Gate-Collector Charge		--	39	55	nC

Electrical Characteristics of the DIODE @ Inverter & Brake $T_C = 25^\circ\text{C}$ unless otherwise noted

Symbol	Parameter	Test Conditions	Min.	Typ.	Max.	Units	
V_{FM}	Diode Forward Voltage	$I_F = 30\text{A}$	$T_C = 25^\circ\text{C}$	--	2.0	2.8	V
			$T_C = 100^\circ\text{C}$	--	2.0	--	
t_{rr}	Diode Reverse Recovery Time		$T_C = 25^\circ\text{C}$	--	90	180	ns
			$T_C = 100^\circ\text{C}$	--	130	--	
I_{rr}	Diode Peak Reverse Recovery Current	$I_F = 30\text{A}$ $di/dt = 60\text{ A/us}$	$T_C = 25^\circ\text{C}$	--	2.2	3.4	A
			$T_C = 100^\circ\text{C}$	--	3.4	--	
Q_{rr}	Diode Reverse Recovery Charge		$T_C = 25^\circ\text{C}$	--	400	600	nC
			$T_C = 100^\circ\text{C}$	--	880	--	

Electrical Characteristics of the DIODE @ Converter $T_C = 25^\circ\text{C}$ unless otherwise noted

Symbol	Parameter	Test Conditions	Min.	Typ.	Max.	Units	
V_{FM}	Diode Forward Voltage	$I_F = 30\text{A}$	$T_C = 25^\circ\text{C}$	--	1.1	1.5	V
			$T_C = 100^\circ\text{C}$	--	1.0	--	
I_{RRM}	Repetitive Reverse Current	$V_R = V_{RRM}$	$T_C = 25^\circ\text{C}$	--	--	8	mA
			$T_C = 100^\circ\text{C}$	--	5	--	

Thermal Characteristics

	Symbol	Parameter	Typ.	Max.	Units
Inverter	$R_{\theta JC}$	Junction-to-Case (IGBT Part, per 1/6 Module)	--	1.0	$^\circ\text{C/W}$
	$R_{\theta JC}$	Junction-to-Case (DIODE Part, per 1/6 Module)	--	2.2	$^\circ\text{C/W}$
Brake	$R_{\theta JC}$	Junction-to-Case (IGBT Part)	--	1.0	$^\circ\text{C/W}$
	$R_{\theta JC}$	Junction-to-Case (DIODE Part)	--	2.2	$^\circ\text{C/W}$
Converter	$R_{\theta JC}$	Junction-to-Case (DIODE Part, per 1/6 Module)	--	2.0	$^\circ\text{C/W}$
Weight		Weight of Module	270	--	g

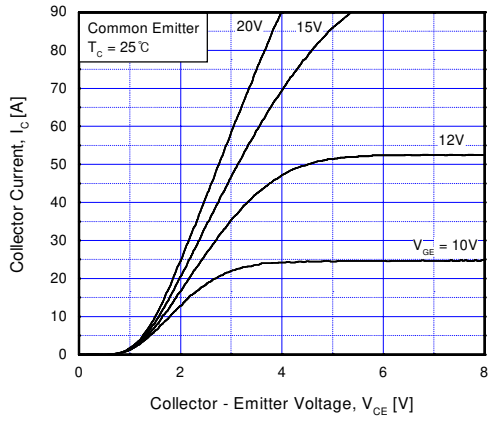

Fig 1. Typical Output Characteristics

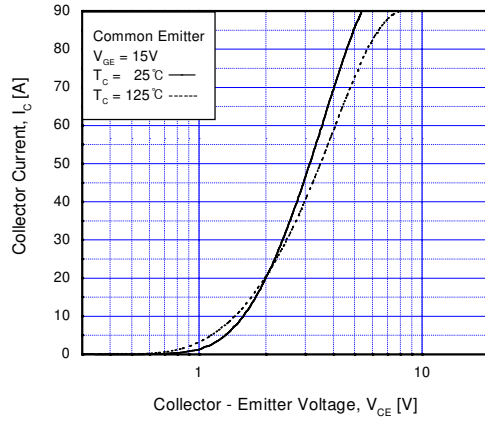

Fig 2. Typical Saturation Voltage Characteristics

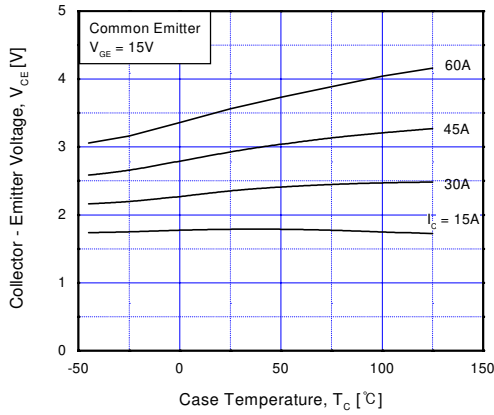

Fig 3. Saturation Voltage vs. Case Temperature at Variant Current Level

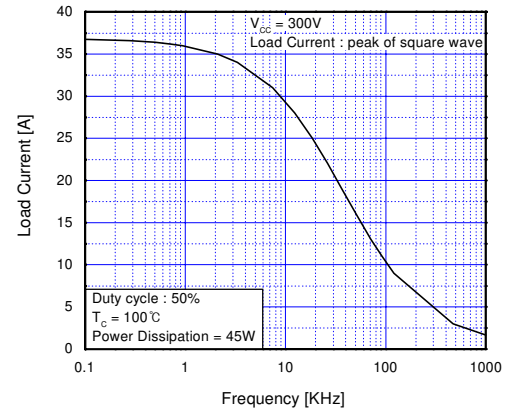

Fig 4. Load Current vs. Frequency

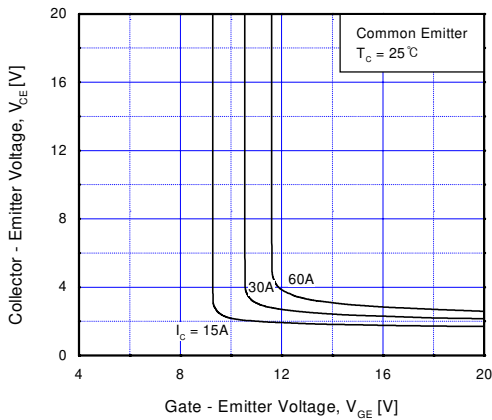

Fig 5. Saturation Voltage vs. V_{GE}

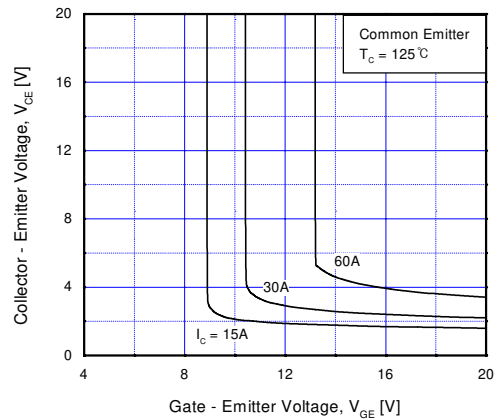

Fig 6. Saturation Voltage vs. V_{GE}

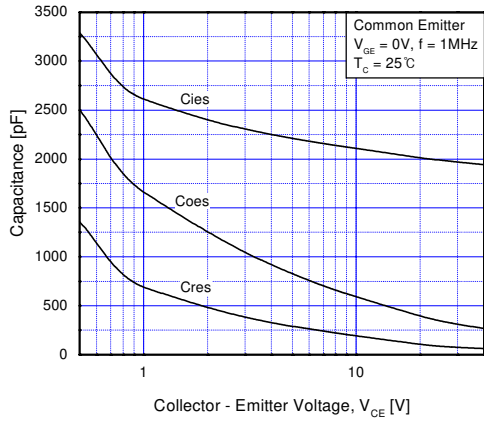

Fig 7. Capacitance Characteristics

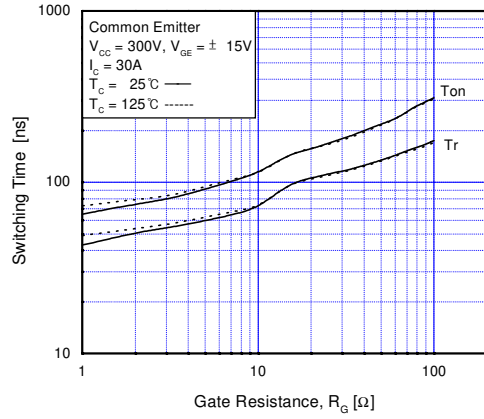

Fig 8. Turn-On Characteristics vs. Gate Resistance

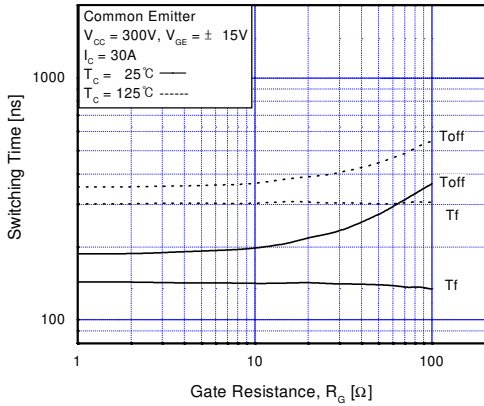

Fig 9. Turn-Off Characteristics vs. Gate Resistance

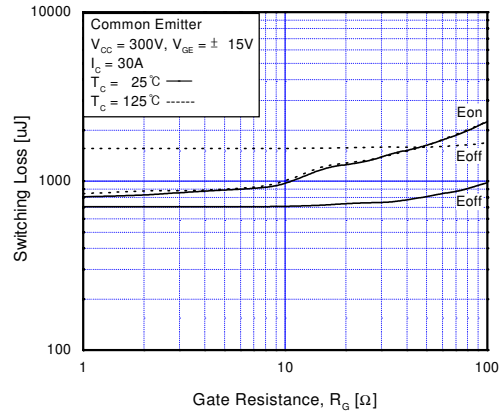

Fig 10. Switching Loss vs. Gate Resistance

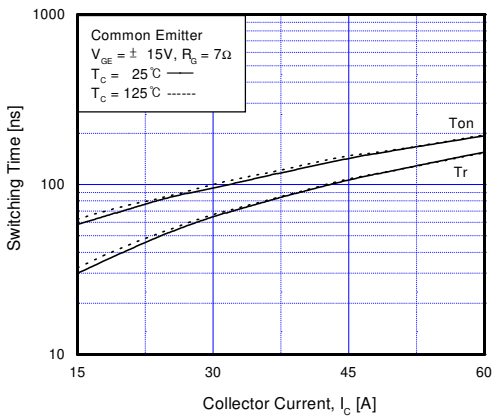

Fig 11. Turn-On Characteristics vs. Collector Current

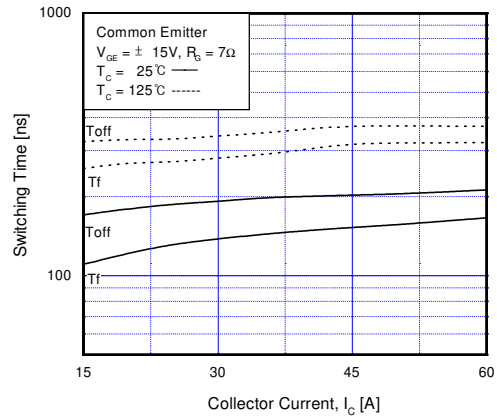

Fig 12. Turn-Off Characteristics vs. Collector Current

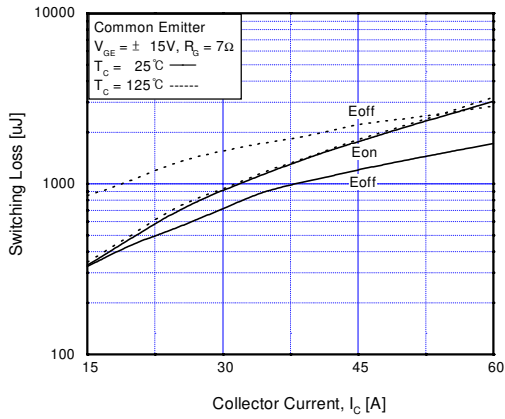

Fig 13. Switching Loss vs. Collector Current

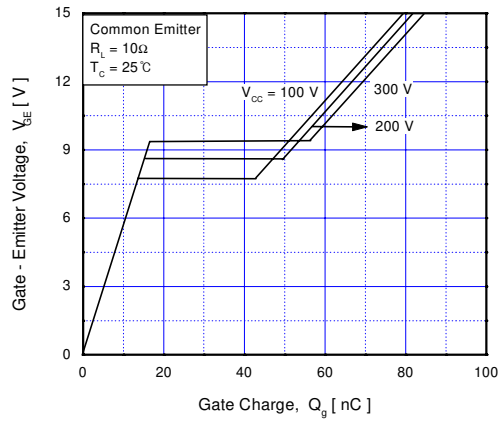

Fig 14. Gate Charge Characteristics

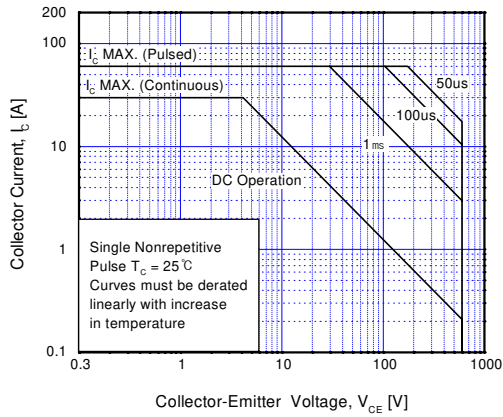

Fig 15. SOA Characteristics

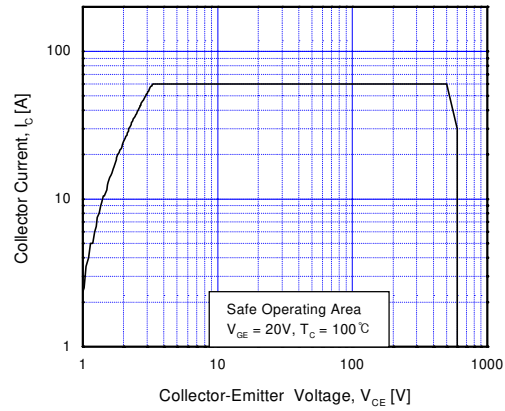

Fig 16. Turn-Off SOA Characteristics

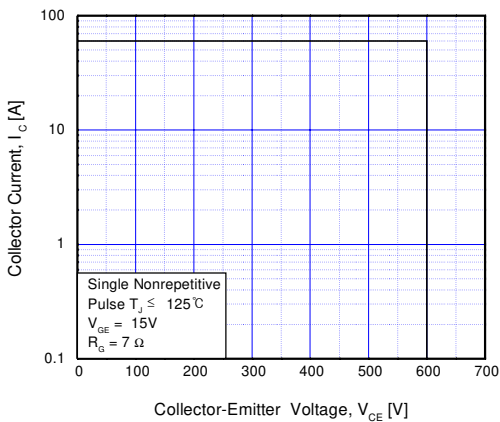

Fig 17. RBSOA Characteristics

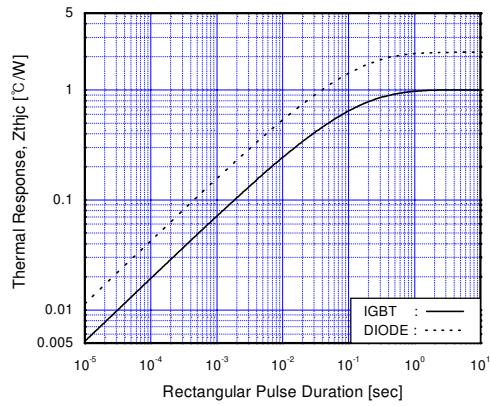

Fig 18. Transient Thermal Impedance

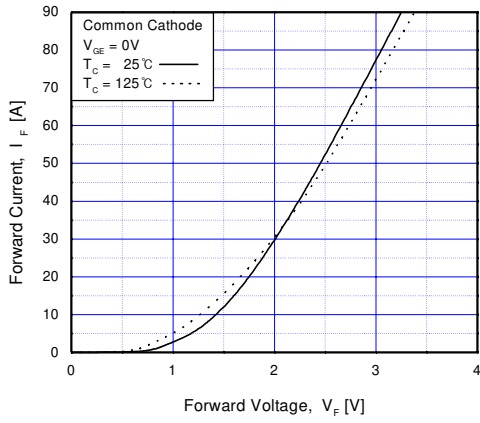

Fig 19. Forward Characteristics

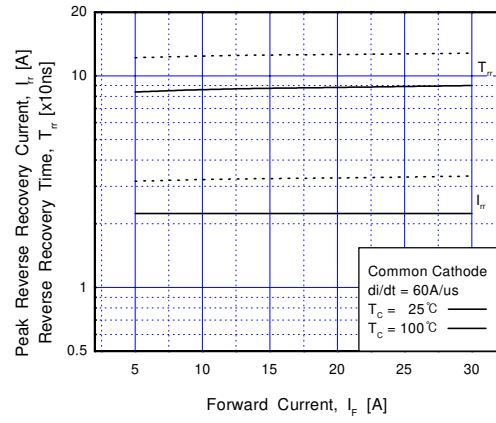
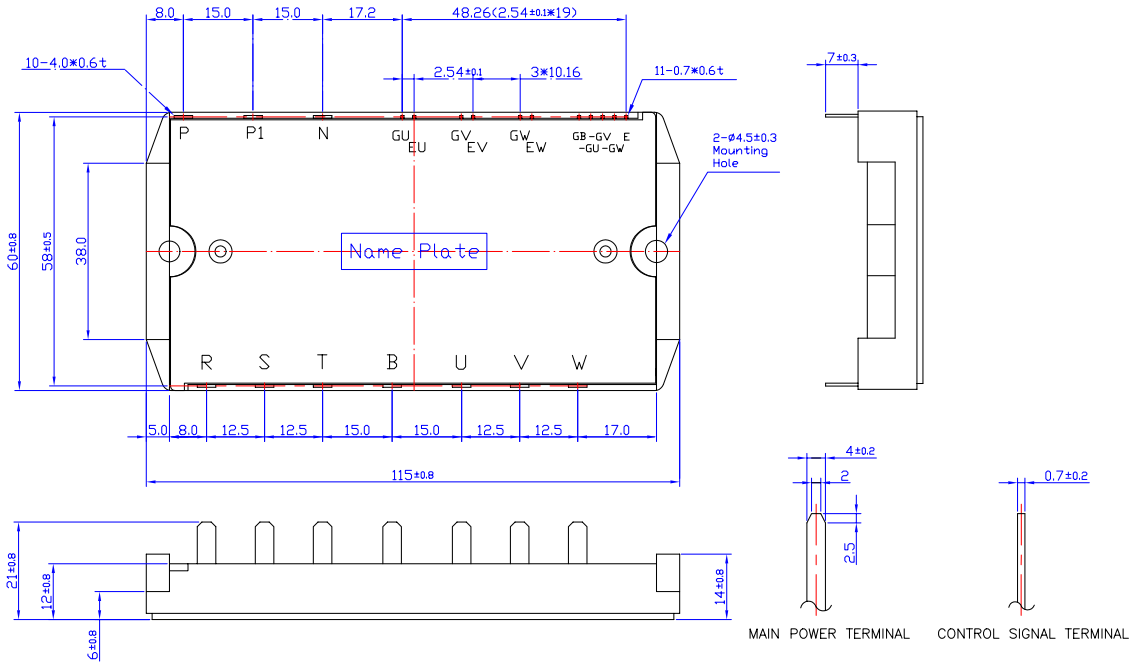

Fig 20. Reverse Recovery Characteristics

Package Dimension

21PM-BA (FS PKG CODE BK)



Dimensions in Millimeters

TRADEMARKS

The following are registered and unregistered trademarks Fairchild Semiconductor owns or is authorized to use and is not intended to be an exhaustive list of all such trademarks.

ACE _x TM	FAST [®]	OPTOLOGIC TM	SMART START TM	VCX TM
Bottomless TM	FAST _r TM	OPTOPLANAR TM	STAR*POWER TM	
CoolFET TM	FRFET TM	PACMAN TM	Stealth TM	
CROSSVOLT TM	GlobalOptoisolator TM	POP TM	SuperSOT TM -3	
DenseTrench TM	GTO TM	Power247 TM	SuperSOT TM -6	
DO _M E TM	HiSeC TM	PowerTrench [®]	SuperSOT TM -8	
EcoSPARK TM	ISOPLANAR TM	QFET TM	SyncFET TM	
E ² C _{MOS} TM	LittleFET TM	QS TM	TruTranslation TM	
EnSigna TM	MicroFET TM	QT Optoelectronics TM	TinyLogic TM	
FACT TM	MicroPak TM	Quiet Series TM	UHC TM	
FACT Quiet Series TM	MICROWIRE TM	SLIENT SWITCHER [®]	UltraFET [®]	

STAR*POWER is used under license

DISCLAIMER

FAIRCHILD SEMICONDUCTOR RESERVES THE RIGHT TO MAKE CHANGES WITHOUT FURTHER NOTICE TO ANY PRODUCTS HEREIN TO IMPROVE RELIABILITY, FUNCTION OR DESIGN. FAIRCHILD DOES NOT ASSUME ANY LIABILITY ARISING OUT OF THE APPLICATION OR USE OF ANY PRODUCT OR CIRCUIT DESCRIBED HEREIN; NEITHER DOES IT CONVEY ANY LICENSE UNDER ITS PATENT RIGHTS, NOR THE RIGHTS OF OTHERS.

LIFE SUPPORT POLICY

FAIRCHILD'S PRODUCTS ARE NOT AUTHORIZED FOR USE AS CRITICAL COMPONENTS IN LIFE SUPPORT DEVICES OR SYSTEMS WITHOUT THE EXPRESS WRITTEN APPROVAL OF FAIRCHILD SEMICONDUCTOR INTERNATIONAL.

As used herein:

1. Life support devices or systems are devices or systems which, (a) are intended for surgical implant into the body, or (b) support or sustain life, or (c) whose failure to perform when properly used in accordance with instructions for use provided in the labeling, can be reasonably expected to result in significant injury to the user.
2. A critical component is any component of a life support device or system whose failure to perform can be reasonably expected to cause the failure of the life support device or system, or to affect its safety or effectiveness.

PRODUCT STATUS DEFINITIONS

Definition of Terms

Datasheet Identification	Product Status	Definition
Advance Information	Formative or In Design	This datasheet contains the design specifications for product development. Specifications may change in any manner without notice.
Preliminary	First Production	This datasheet contains preliminary data, and supplementary data will be published at a later date. Fairchild Semiconductor reserves the right to make changes at any time without notice in order to improve design.
No Identification Needed	Full Production	This datasheet contains final specifications. Fairchild Semiconductor reserves the right to make changes at any time without notice in order to improve design.
Obsolete	Not In Production	This datasheet contains specifications on a product that has been discontinued by Fairchild semiconductor. The datasheet is printed for reference information only.