

160 KA, 120 V UN, 1PH 2W+G DIST SYSTEM

CATALOG NUMBER

SES160F120V



The nVent ERICO SES160F Series is an enhanced version of the SES160B Series. The SES160F Surge-Filter is robust, with a 160 kA per phase surge rating. The high surge rating increases both survivability and life cycle. With the addition of a filter nuisance high frequency transients on the power distribution system are attenuated, protecting sensitive equipment. cUL® 1449 Listed SPD for Type 2 locations. Applications include service entrance, distribution, branch panels, MCC, lighting panels, HVAC, A/V systems, IT equipment, and more.

CERTIFICATIONS



FEATURES

Compact design can be directly mounted to panel or installed in a small space

Front-facing design eases installation and performance monitoring

160 kA 8/20 μ s maximum surge rating per phase

Up to 57 dB attenuation (10 kHz to 100 MHz)

Optional Flush Mounting Plate

Ground reference monitoring triggers an alarm when N-PE mode exceeds 20 volts

10-year limited warranty

PRODUCT ATTRIBUTES

Nominal System Voltage (Un): 120 V

Distribution System: 1Ph 2W+G

Max Continuous Operating Voltage (Uc): 180 V

Filtering: -40 dB @ 100 kHz dB

Frequency: 0 – 600 Hz

Short Circuit Current Rating (SCCR): 200 kA

Nominal Discharge Current (In), Per Mode: 20 kA 8/20 -s

Max Discharge Current (Imax), Per Phase: 160 kA 8/20 -s

Voltage Protection Rating (VPR), L-N: 700 V

Voltage Protection Rating (VPR), L-PE: 700 V

Voltage Protection Rating (VPR), N-PE: 700 V

Protection Modes: All modes protected

Status Indication: 1 green LED per line; Audible alarm; Change-over contact (Form C dry), 240 VAC/2A

Remote Contact Switching Capacity: 2 A @ 240 V A

Remote Contacts: Yes

Lead Length: 18"

Temperature: -40 to 185 °F

Enclosure Material: Polycarbonate

Enclosure Rating: NEMA®-4X; UL® 50E Type 4

Mounting: 3/4- straight nipple

Unit Weight: 1.38 lb

Certification Details: CSA C22.2 No. 269.2; UL® 1283 Edition 7; UL® 1449 Edition 5 Type 2, 20 kA Mode

Complies With: ANSI®/IEEE® C62.41.2-2002 Cat A, Cat B, Cat C; ANSI®/IEEE® C62.41.1-2002 Cat A, Cat B, Cat C; ANSI®/IEEE® C62.45-2002 Cat A, Cat B, Cat C

Depth (D): 3.06"

Height (H): 2 3/4"

Width (W): 7.95"

DIAGRAMS

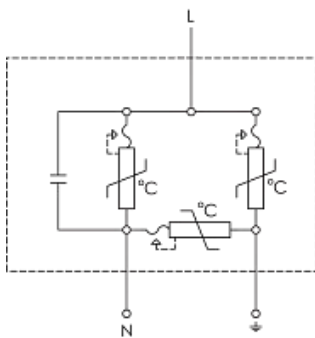

WARNING

nVent products shall be installed and used only as indicated in nVent's product instruction sheets and training materials. Instruction sheets are available at www.nvent.com and from your nVent customer service representative. Improper installation, misuse, misapplication or other failure to completely follow nVent's instructions and warnings may cause product malfunction, property damage, serious bodily injury and death and/or void your warranty.

North America

+1.800.753.9221

Option 1 – Customer Care

Option 2 – Technical Support

Europe

Netherlands:

+31 800-0200135

France:

+33 800 901 793

Europe

Germany:

800 1890272

Other Countries:

+31 13 5835404

APAC

Shanghai:

+ 86 21 2412 1618/19

Sydney:

+61 2 9751 8500



Our powerful portfolio of brands:
nVent.com CADDY ERICO HOFFMAN RAYCHEM SCHROFF
TRACER