

# SERPAC 2024, DB25 for A42

Electronic Enclosures

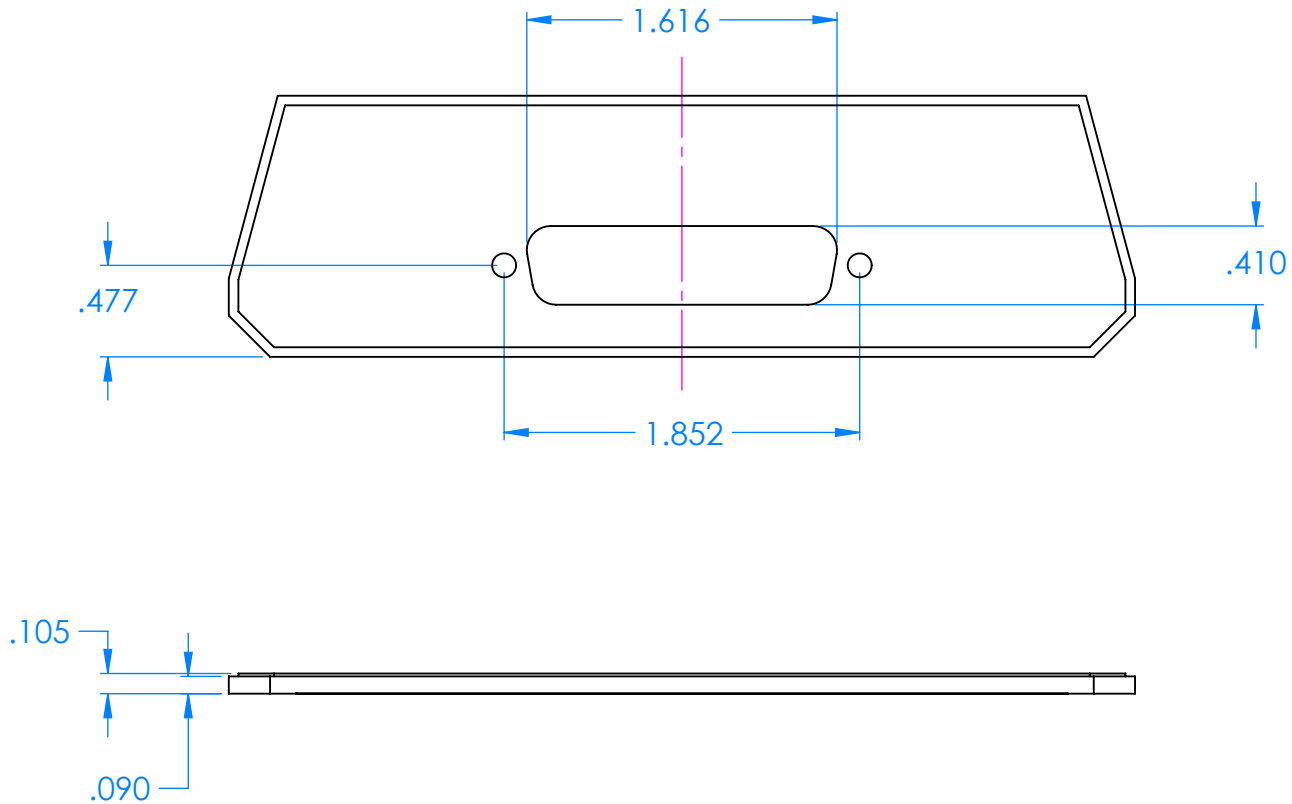

**NOTES:**

Cutout located to accept a D-sub standard surface mount DB25 connector (male or female) using a .065" thick circuit board.