

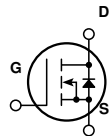

Linear Mosfets are optimized for applications operating in the Linear region where concurrent high voltage and high current can occur at near DC conditions (>100 msec).

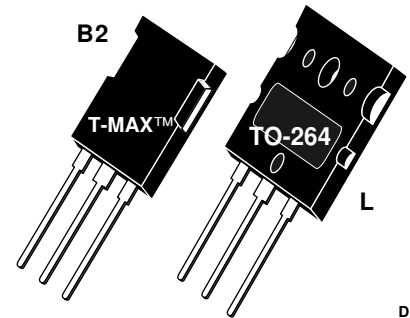

- Higher FBSOA
- Popular T-MAX™ or TO-264 Package
- Higher Power Dissipation

**MAXIMUM RATINGS**

 All Ratings:  $T_C = 25^\circ\text{C}$  unless otherwise specified.

Symbol	Parameter	APL602B2-L(G)	UNIT
$V_{DSS}$	Drain-Source Voltage	600	Volts
$I_D$	Continuous Drain Current @ $T_C = 25^\circ\text{C}$	49	Amps
$I_{DM}$	Pulsed Drain Current <sup>①</sup>	196	
$V_{GS}$	Gate-Source Voltage Continuous	$\pm 30$	Volts
$V_{GSM}$	Gate-Source Voltage Transient	$\pm 40$	
$P_D$	Total Power Dissipation @ $T_C = 25^\circ\text{C}$	730	Watts
	Linear Derating Factor	5.84	W/ $^\circ\text{C}$
$T_J, T_{STG}$	Operating and Storage Junction Temperature Range	-55 to 150	$^\circ\text{C}$
$T_L$	Lead Temperature: 0.063" from Case for 10 Sec.	300	
$I_{AR}$	Avalanche Current <sup>①</sup> (Repetitive and Non-Repetitive)	49	Amps
$E_{AR}$	Repetitive Avalanche Energy <sup>①</sup>	50	mJ
$E_{AS}$	Single Pulse Avalanche Energy <sup>④</sup>	3000	

**STATIC ELECTRICAL CHARACTERISTICS**

Symbol	Characteristic / Test Conditions / Part Number	MIN	TYP	MAX	UNIT
$BV_{DSS}$	Drain-Source Breakdown Voltage ( $V_{GS} = 0V, I_D = 250 \mu\text{A}$ )	600			Volts
$I_{D(ON)}$	On State Drain Current <sup>②</sup> ( $V_{DS} > I_{D(ON)} \times R_{DS(ON)}$ Max, $V_{GS} = 12V$ )	49			Amps
$R_{DS(ON)}$	Drain-Source On-State Resistance <sup>②</sup> ( $V_{GS} = 12V, 24.5A$ )			0.125	Ohms
$I_{DSS}$	Zero Gate Voltage Drain Current ( $V_{DS} = 600V, V_{GS} = 0V$ )			25	$\mu\text{A}$
	Zero Gate Voltage Drain Current ( $V_{DS} = 480V, V_{GS} = 0V, T_C = 125^\circ\text{C}$ )			250	
$I_{GSS}$	Gate-Source Leakage Current ( $V_{GS} = \pm 30V, V_{DS} = 0V$ )			$\pm 100$	nA
$V_{GS(TH)}$	Gate Threshold Voltage ( $V_{DS} = V_{GS}, I_D = 2.5mA$ )	2		4	Volts

 **CAUTION:** These Devices are Sensitive to Electrostatic Discharge. Proper Handling Procedures Should Be Followed.

**DYNAMIC CHARACTERISTICS**

**APL602B2-L(G)**

Symbol	Characteristic	Test Conditions	MIN	TYP	MAX	UNIT
$C_{iss}$	Input Capacitance	$V_{GS} = 0V$ $V_{DS} = 25V$ $f = 1\text{ MHz}$		7485	9000	pF
$C_{oss}$	Output Capacitance			1290	1810	
$C_{rss}$	Reverse Transfer Capacitance			617	930	
$t_{d(on)}$	Turn-on Delay Time	$V_{GS} = 15V$ $V_{DD} = 300V$ $I_D = 49A @ 25^\circ C$ $R_G = 0.6\Omega$		13	26	ns
$t_r$	Rise Time			27	54	
$t_{d(off)}$	Turn-off Delay Time			56	84	
$t_f$	Fall Time			16	20	

**THERMAL CHARACTERISTICS**

Symbol	Characteristic	MIN	TYP	MAX	UNIT
$R_{\theta JC}$	Junction to Case			.17	$^\circ C/W$
$R_{\theta JA}$	Junction to Ambient			40	

- ① Repetitive Rating: Pulse width limited by maximum junction temperature.
  - ② Pulse Test: Pulse width < 380  $\mu S$ , Duty Cycle < 2%
  - ③ See MIL-STD-750 Method 3471
  - ④ Starting  $T_j = +25^\circ C$ ,  $L = 2.50mH$ ,  $R_G = 25\Omega$ , Peak  $I_L = 49A$
- APT Reserves the right to change, without notice, the specifications and information contained herein.**

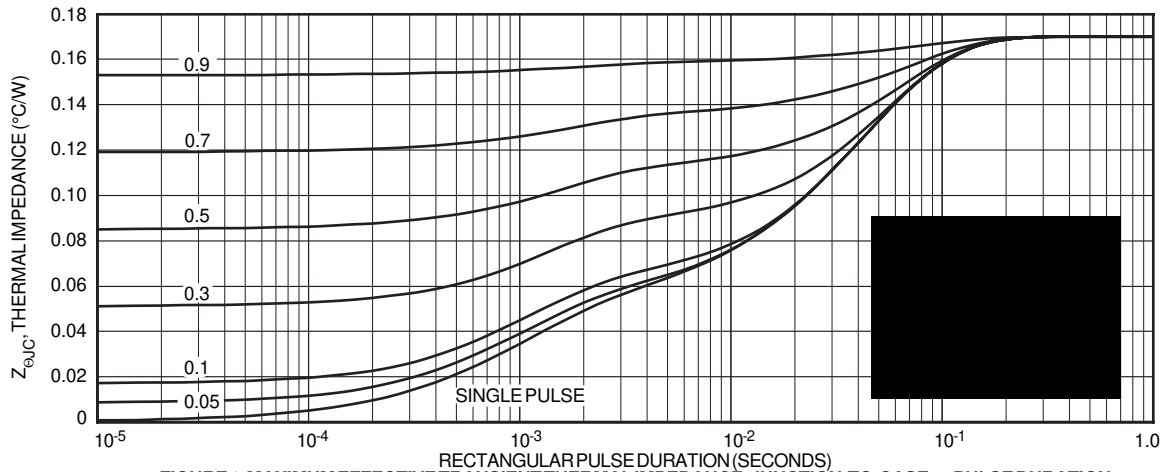

**FIGURE 1, MAXIMUM EFFECTIVE TRANSIENT THERMAL IMPEDANCE, JUNCTION-TO-CASE vs PULSE DURATION**

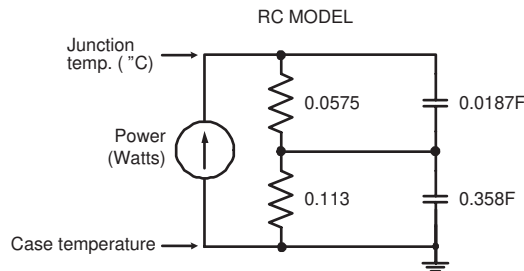

**FIGURE 1a, TRANSIENT THERMAL IMPEDANCE MODEL**

Typical Performance Curves

APL602B2-L(G)

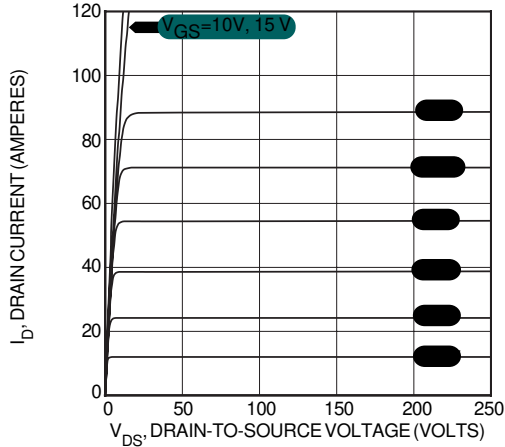

FIGURE 2, HIGH VOLTAGE OUTPUT CHARACTERISTICS

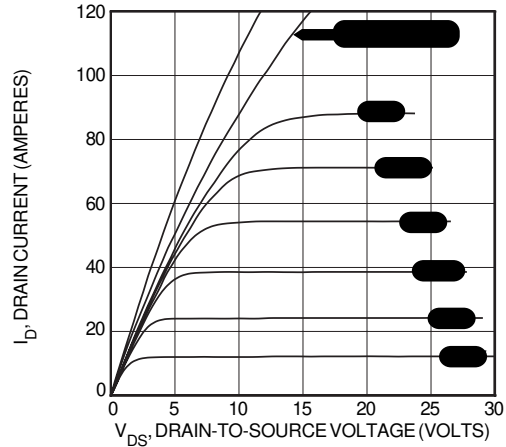

FIGURE 3, LOW VOLTAGE OUTPUT CHARACTERISTICS

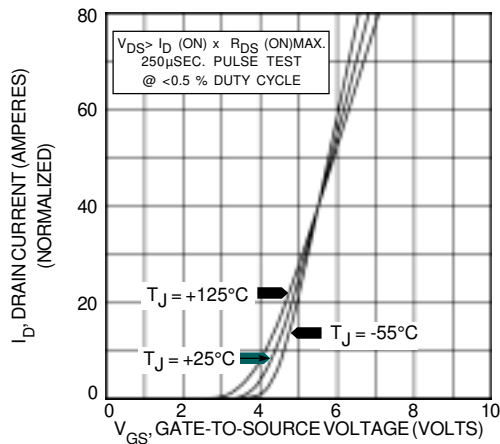

FIGURE 4, TRANSFER CHARACTERISTICS

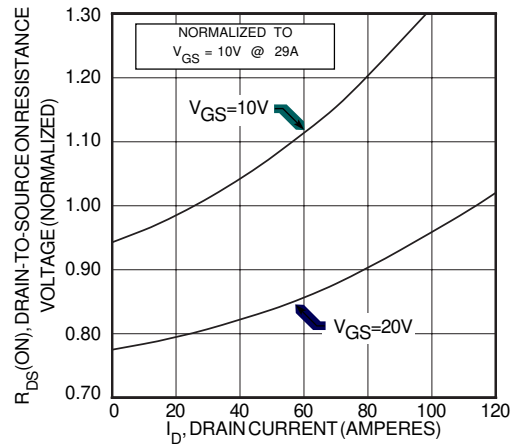

FIGURE 5,  $R_{DS(ON)}$  vs DRAIN CURRENT

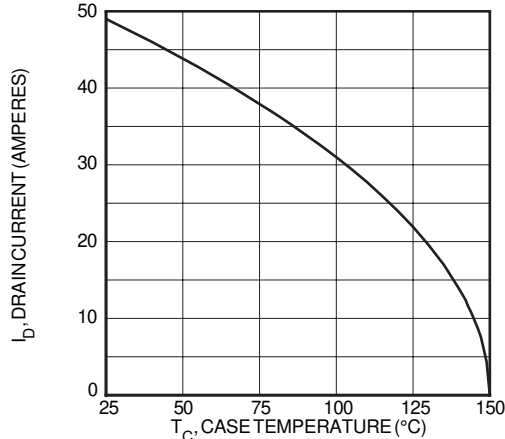

FIGURE 6, MAXIMUM DRAIN CURRENT vs CASE TEMPERATURE

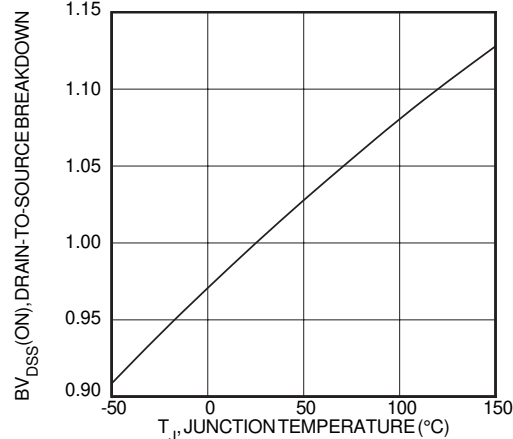

FIGURE 7, BREAKDOWN VOLTAGE vs TEMPERATURE

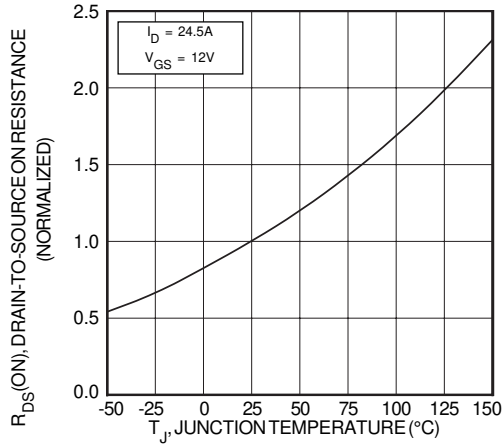

FIGURE 8, ON-RESISTANCE vs. TEMPERATURE

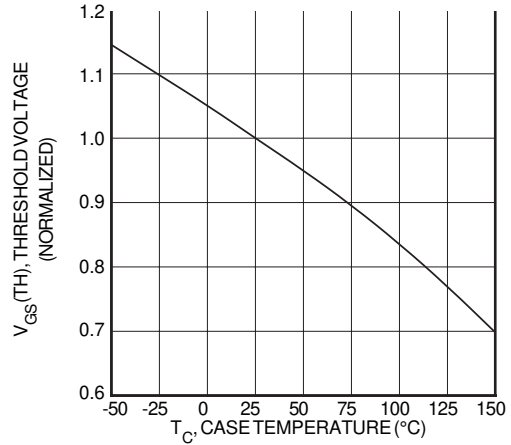

FIGURE 9, THRESHOLD VOLTAGE vs TEMPERATURE

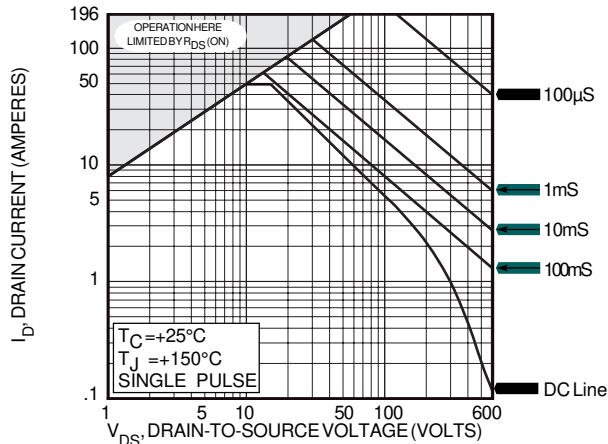

FIGURE 10, MAXIMUM SAFE OPERATING AREA

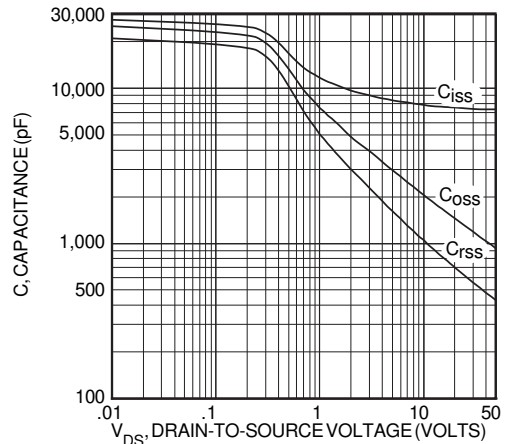
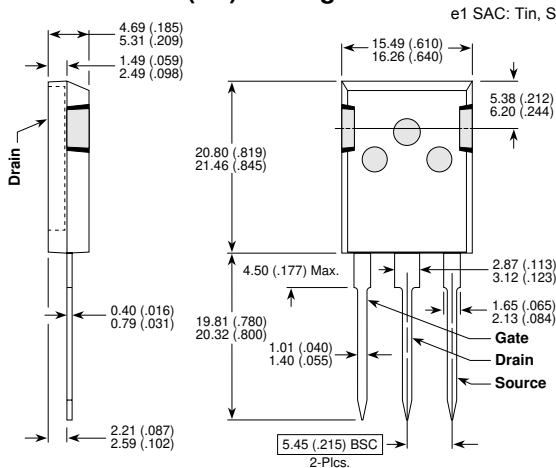

FIGURE 11, CAPACITANCE vs DRAIN-TO-SOURCE VOLTAGE

T-MAX™ (B2) Package Outline



These dimensions are equal to the TO-247 without the mounting hole.  
Dimensions in Millimeters and (Inches)

TO-264 (L) Package Outline

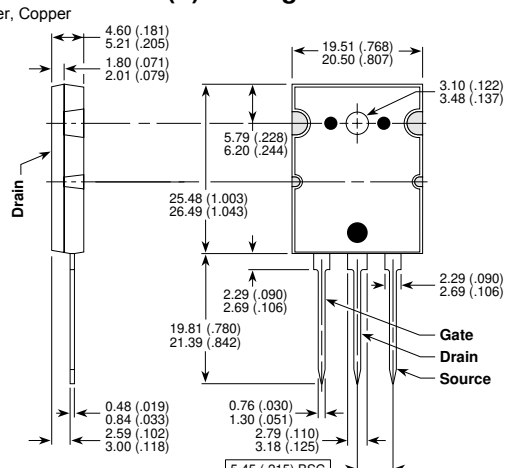

Dimensions in Millimeters and (Inches)

e1 SAC: Tin, Silver, Copper