

CGHV50200F

200 W, 4.4 - 5.0 GHz, 50-Ohm Input/Output Matched, GaN HEMT

Description

Wolfspeed's CGHV50200F is a gallium nitride (GaN) high electron mobility transistor (HEMT) designed specifically with high efficiency, high gain and wide bandwidth capabilities, which makes the CGHV50200F ideal for troposcatter communications, 4.4 - 5.0 GHz C-Band SatCom applications and Beyond Line of Sight. The GaN HEMT is matched to 50 ohm, for ease of use. It is designed for CW, pulse, and linear mode of power amplifier operation. The transistor is supplied in a ceramic/metal flange package, type 440217.

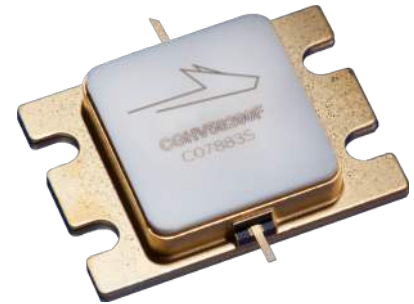

PN: CGHV50200F
Package Type: 440217

Features

- 4.4 - 5.0 GHz Operation
- 180 W Typical P_{SAT}
- 11.5 dB Typical Power Gain
- 48% Typical Power Efficiency
- 50 Ohm Internally Matched

Applications

- Troposcatter Communications
- Beyond Line of Sight – BLOS
- Satellite Communications

Typical Performance Over 4.4-5.0 GHz ($T_c = 25^\circ\text{C}$) of Demonstration Amplifier

Parameter	4.4 GHz	4.6 GHz	4.8 GHz	5.0 GHz	Units
Small Signal Gain	14.9	14.9	14.9	15.1	dB
CW Output Power ¹	173	177	170	166	W
Output Power ²	100	100	126	101	W
Power Gain ²	11.4	11.6	11.0	11.8	dB
Power Added Efficiency ²	49	47	48	48	%

Notes:

¹ Measured CW in the CGHV50200F-AMP at $P_{IN} = 43$ dBm

² Measured at -30 dBc, 1.6 MHz from carrier, in the CGHV50200F-AMP1 under OQPSK modulation, 1.6 Msps, PN23, Alpha Filter = 0.2

 Large Signal Models Available for ADS and MWO





Absolute Maximum Ratings (not simultaneous)

Parameter	Symbol	Rating	Units	Conditions
Drain-Source Voltage	V_{DS}	120	V	25°C
Gate-to-Source Voltage	V_{GS}	-10, +2		
Storage Temperature	T_{STG}	-65, +150	°C	
Operating Junction Temperature	T_J	225		
Maximum Forward Gate Current	I_{GMAX}	41.6	mA	25°C
Maximum Drain Current ¹	I_{DMAX}	17	A	
Soldering Temperature ²	T_S	245	°C	
Screw Torque	τ	40	in-oz	
Thermal Resistance, Junction to Case	$R_{\theta JC}$	0.81	°C/W	CW, 85°C, $P_{DISS} = 166.4$ W
Case Operating Temperature ³	T_C	-40, +150	°C	

Notes:

¹ Current limit for long term, reliable operation

² Refer to the Application Note on soldering at wolfspeed.com/rf/document-library

³ See also, Power Dissipation Derating Curve on page 11

Electrical Characteristics

Characteristics	Symbol	Min.	Typ.	Max.	Units	Conditions
DC Characteristics¹ ($T_C = 25^\circ\text{C}$)						
Gate Threshold Voltage	$V_{GS(th)}$	-3.4	-3.0	-2.6	V_{DC}	$V_{DS} = 10$ V, $I_D = 41.6$ mA
Gate Quiescent Voltage	$V_{GS(Q)}$	—	-2.7	—		$V_{DS} = 50$ V, $I_D = 1.0$ A
Saturated Drain Current ²	I_{DS}	33.28	37.4	—	A	$V_{DS} = 6$ V, $V_{GS} = 2$ V
Drain-Source Breakdown Voltage	V_{BR}	100	—	—	V_{DC}	$V_{GS} = -8$ V, $I_D = 41.6$ mA
RF Characteristics² ($T_C = 25^\circ\text{C}$, $F_0 = 4.4 - 5.0$ GHz unless otherwise noted)						
Small Signal Gain at 4.4 GHz	G_{SS}	14	15.4	—	dB	$V_{DD} = 40$ V, $I_D = 1.0$ A, $P_{IN} = 10$ dBm
Small Signal Gain at 4.8 GHz			15.3	—		
Small Signal Gain at 5.0 GHz			14.25	15.2		
Power Gain ⁴ at 4.4 GHz	G_p	10.5	12.1	—	dB	$V_{DD} = 40$ V, $I_D = 1.0$ A, $P_{OUT} = 48$ dBm
Power Gain ⁴ at 4.8 GHz			12.4	—		
Power Gain ⁴ at 5.0 GHz			12.2	—		
Power Added Efficiency ⁴ at 4.4 GHz	PAE	30	42	—	%	$V_{DD} = 40$ V, $I_D = 1.0$ A, $P_{OUT} = 48$ dBm
Power Added Efficiency ⁴ at 4.8 GHz			37	—		
Power Added Efficiency ⁴ at 5.0 GHz			40	—		
OQPSK Linearity ⁴ at 4.4 GHz	ACLR	—	-29	-25	dBc	No damage at all phase angles, $V_{DD} = 40$ V, $I_D = 1.0$ A, CW $P_{OUT} = 180$ W
OQPSK Linearity ⁴ at 4.8 GHz			-34	-28		
OQPSK Linearity ⁴ at 5.0 GHz			—	-26		
Output Mismatch Stress	VSWR	—	—	3 : 1	Ψ	

Notes:

¹ Measured on wafer prior to packaging

² Scaled from PCM data

³ Measured in CGHV50200F-AMP

⁴ Measured under 1.6 Msps OQPSK Modulation, PN23, Alpha Filter = 0.2



Typical Performance

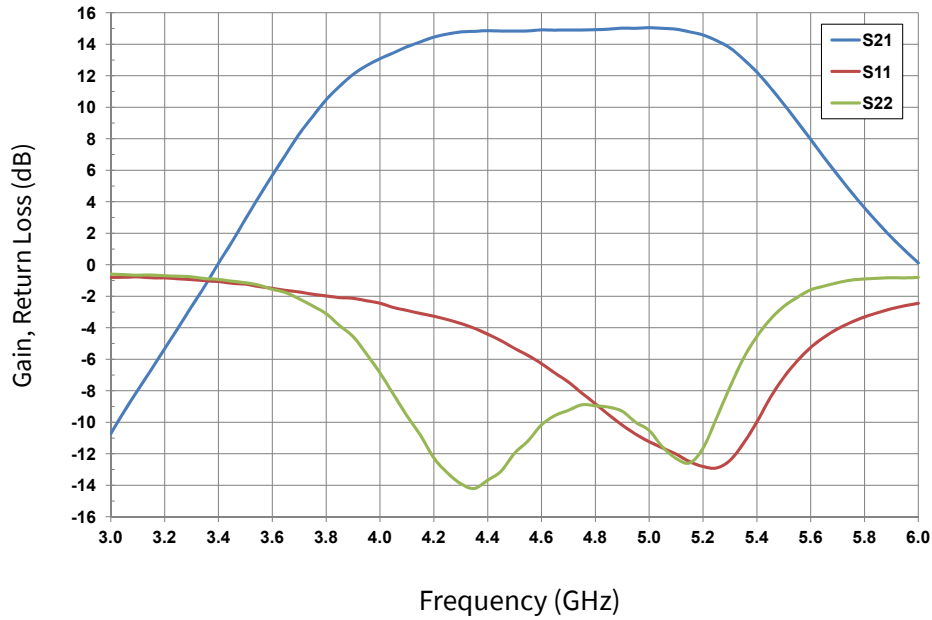

Figure 1. Small Signal S-Parameters CGHV50200F in Test Fixture
 $V_{DD} = 40\text{ V}$, $I_{DQ} = 1\text{ A}$, $T_{CASE} = 25^\circ\text{C}$

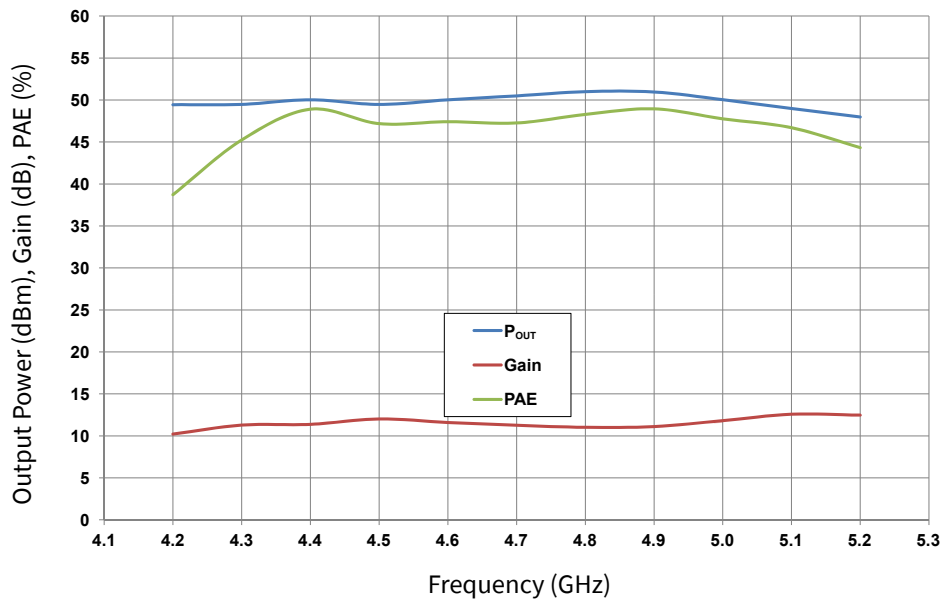

Figure 2. Modulated @ Spectral Regrowth = -30dBc, 1.6 MHz from Carrier 1.6 Msps OQPSK Modulation
 $V_{DD} = 40\text{ V}$, $I_{DQ} = 1\text{ A}$, $T_{CASE} = 25^\circ\text{C}$



Typical Performance

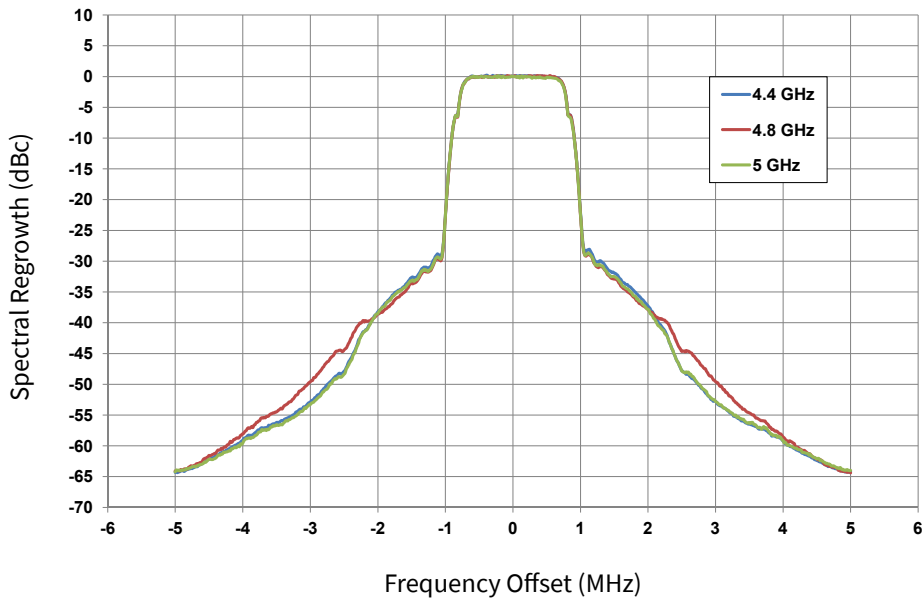

Figure 3. Spectral Mask @ Average Output Power = 48 dBm, 1.6 Msps OQPSK Modulation
 $V_{DD} = 40\text{ V}$, $I_{DQ} = 1\text{ A}$, $T_{CASE} = 25^\circ\text{C}$

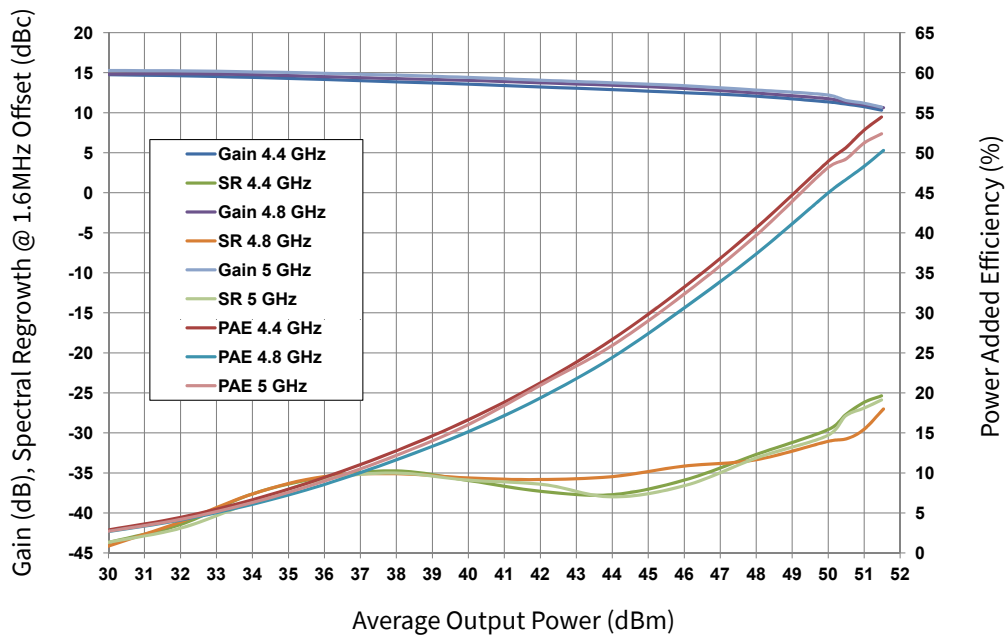

Figure 4. Modulated Power Sweep 1.6 Msps OQPSK Modulation
 $V_{DD} = 40\text{ V}$, $I_{DQ} = 1\text{ A}$, $T_{CASE} = 25^\circ\text{C}$



Typical Performance

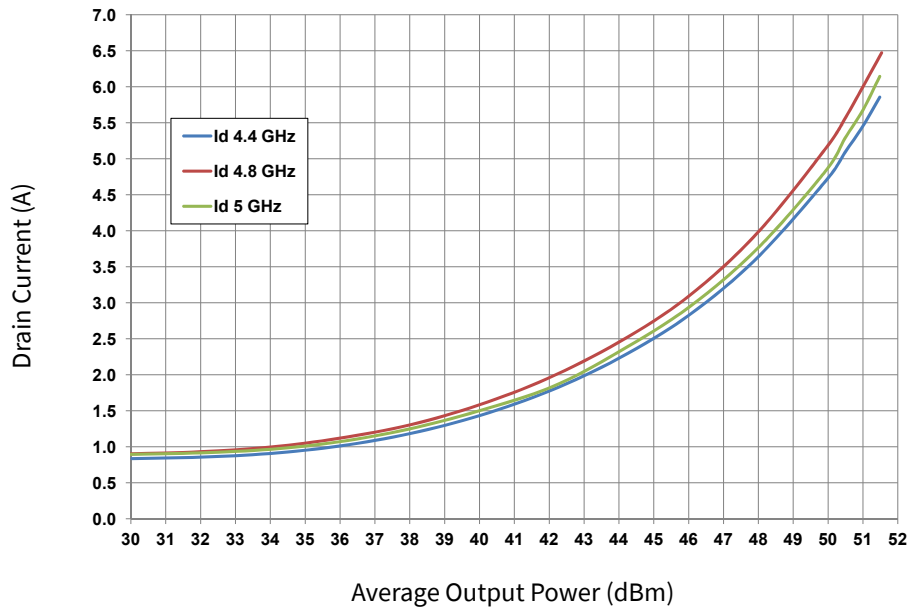

Figure 5. Modulated Power Sweep 1.6 Mps OQPSK Modulation
 $V_{DD} = 40\text{ V}$, $I_{DQ} = 1\text{ A}$, $T_{CASE} = 25^{\circ}\text{C}$

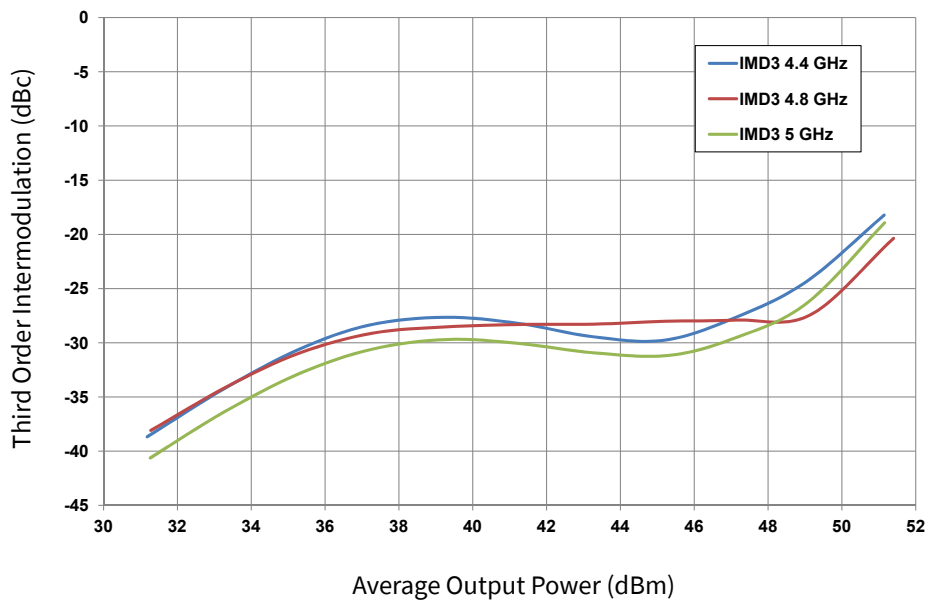

Figure 6. Two Tone Power Sweep IMD3 @ 1 MHz Carrier Spacing
 $V_{DD} = 40\text{ V}$, $I_{DQ} = 1\text{ A}$, $T_{CASE} = 25^{\circ}\text{C}$



Typical Performance

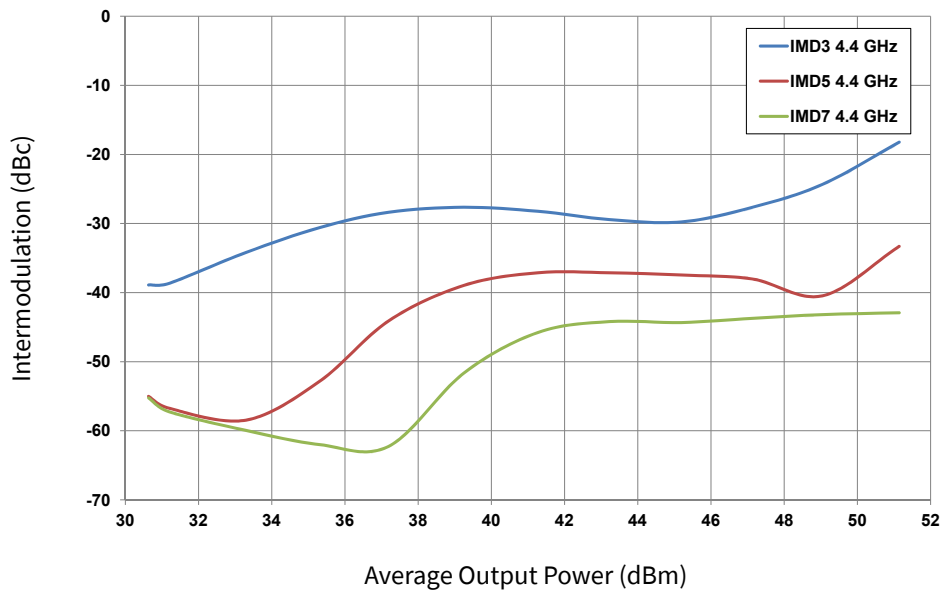

Figure 7. Two Tone Power Sweep
 IMD @ 1 MHz Carrier Spacing, 4.4 GHz
 $V_{DD} = 40\text{ V}$, $I_{DQ} = 1\text{ A}$, $T_{CASE} = 25^\circ\text{C}$

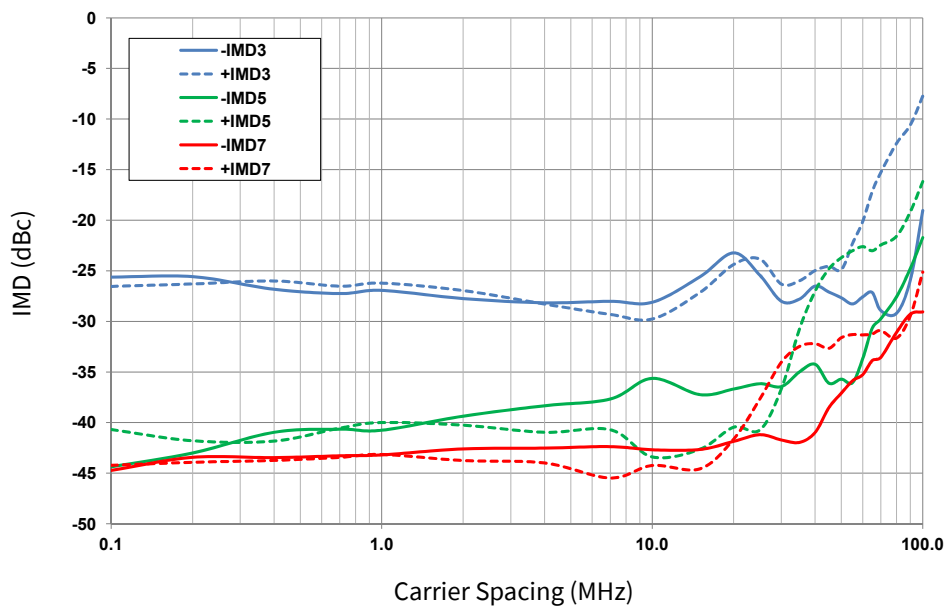

Figure 8. Two Tone Carrier Spacing Sweep @ 48 dBm Average Output Power, 4.4 GHz
 $V_{DD} = 40\text{ V}$, $I_{DQ} = 1\text{ A}$, $T_{CASE} = 25^\circ\text{C}$



Typical Performance

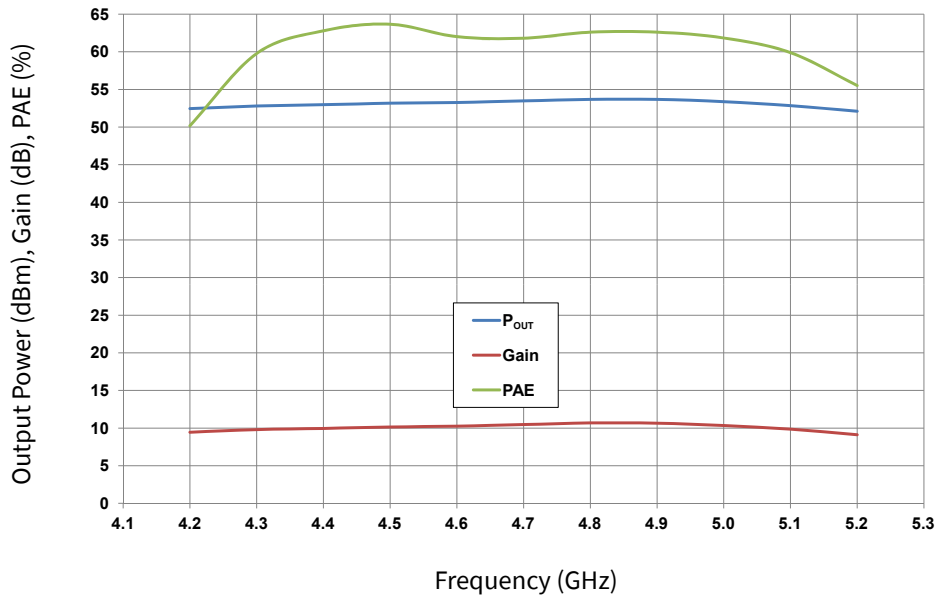

Figure 9. Pulsed vs Frequency @ P_{IN} = 43 dBm
 CGHV50200F in Test Fixture
 10% Duty, 100μs Pulse Width
 V_{DD} = 40 V, I_{DQ} = 1 A, T_{CASE} = 25°C

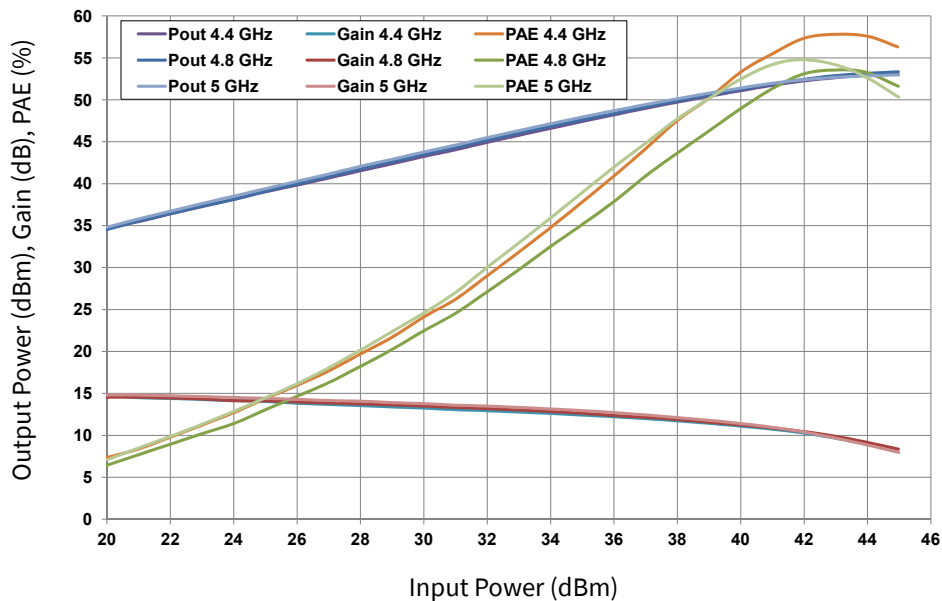

Figure 10. Pulsed Power Sweep
 CGHV50200F in Test Fixture
 10% Duty, 100μs Pulse Width
 V_{DD} = 40 V, I_{DQ} = 1 A, T_{CASE} = 25°C



Typical Performance

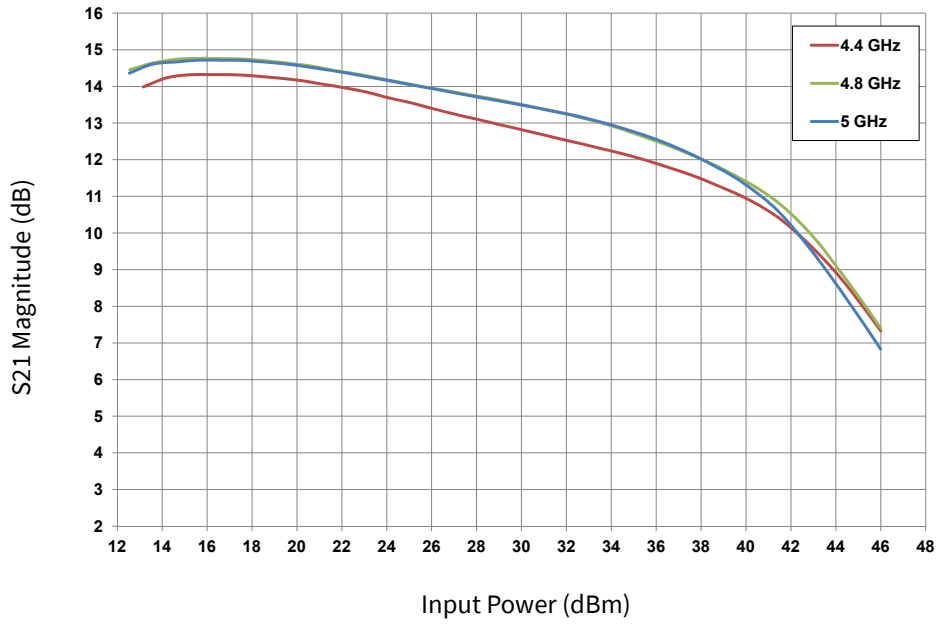

Figure 11. AM-AM
 $V_{DD} = 40\text{ V}$, $I_{DQ} = 1\text{ A}$, $T_{CASE} = 25^\circ\text{C}$

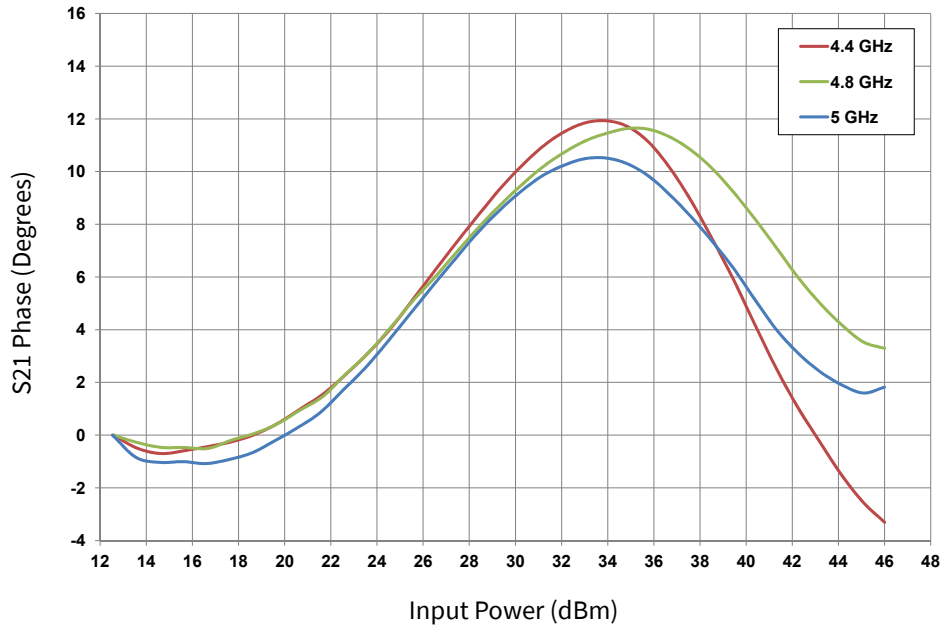
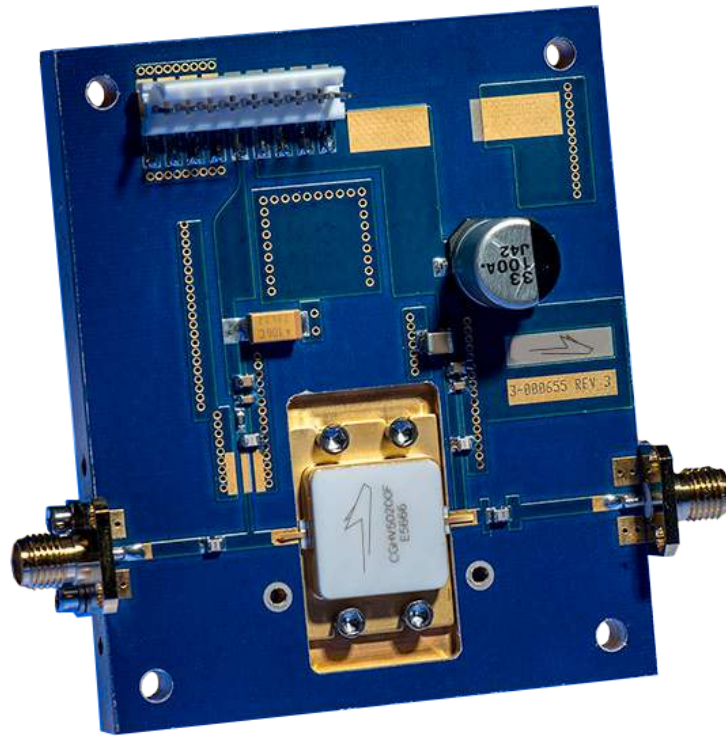

Figure 12. AM-PM
 $V_{DD} = 40\text{ V}$, $I_{DQ} = 1\text{ A}$, $T_{CASE} = 25^\circ\text{C}$



CGHV50200F-AMP Demonstration Amplifier Circuit



CGHV50200F-AMP Demonstration Amplifier Circuit Outline

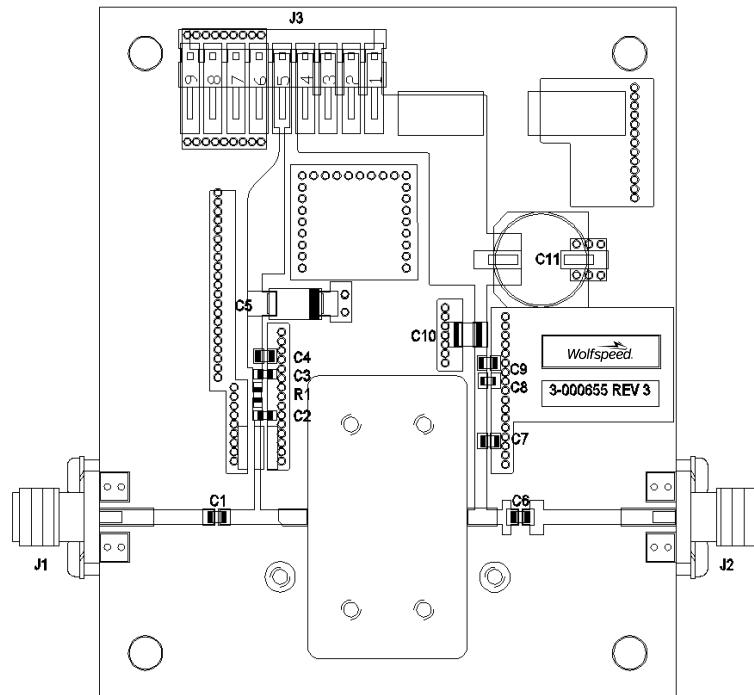



CGHV50200F-AMP Demonstration Amplifier Circuit Outline

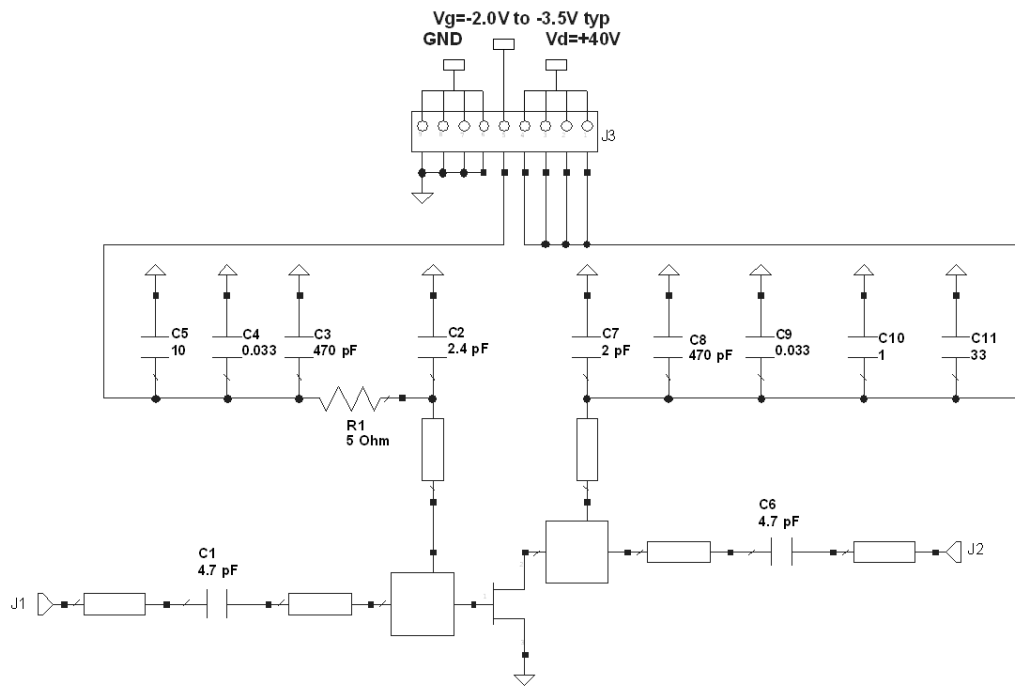

CGHV50200F-AMP Demonstration Amplifier Circuit

Designator	Description	Qty
R1	RES, 5.1, OHM, +/- 1%, 1/16W,0603	1
C1,C6	CAP, 4.7pF, +/-1%, 250V, 0805	2
C2	CAP, 2.4pF, +/- 0.25pF, 250V, 0603	1
C3,C8	CAP, 470pF, 5%, 100V, 0603, X	2
C4,C9	CAP, 33000pF, 0805, 100V, X7R	2
C5	CAP 10μF 16V TANTALUM	1
C7	CAP, 2.0pF, +/-1%, 250V, 0805,	1
C10	CAP, 1.0μF, 100V, 10%, X7R, 1210	1
C11	CAP, 33μF, 20%, G CASE	1
J1,J2	CONN, SMA, PANEL MOUNT JACK	2
J3	HEADER RT>PLZ .1CEN LK 9POS	1
—	PCB, RF35, 2.5 X 3.0 X 0.250	1
—	2-56 SOC HD SCREW 1/4 SS	4
—	#2 SPLIT LOCKWASHER SS	4
Q1	CGHV50200F	1



CGHV50200F Power Dissipation De-rating Curve

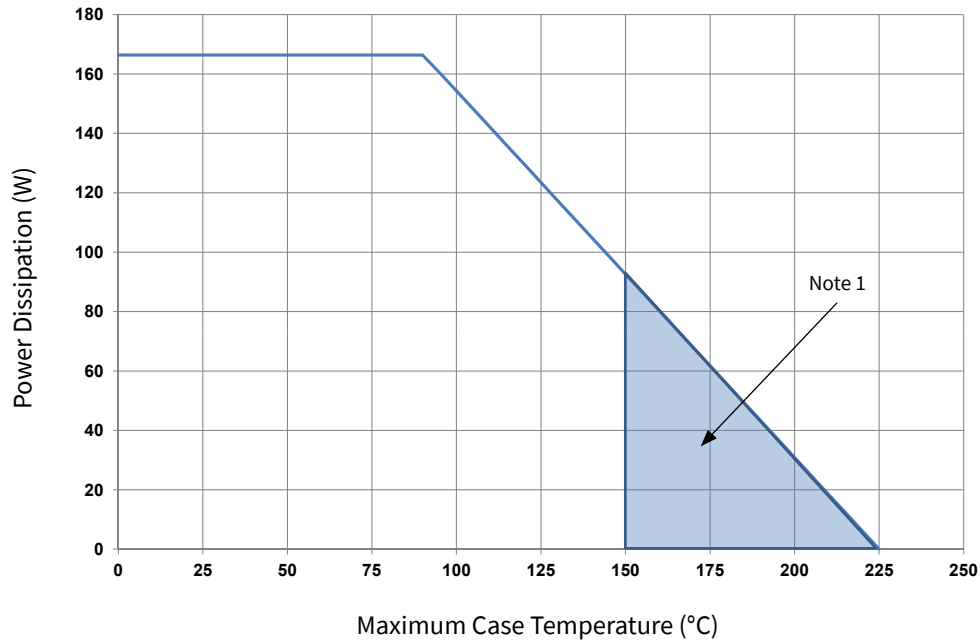

Notes:

¹ Shaded area exceeds Maximum Case Operating Temperature (See Page 2)

Electrostatic Discharge (ESD) Classifications

Parameter	Symbol	Class	Classification Level	Test Methodology
Human Body Model	HBM	1B	ANSI/ESDA/JEDEC JS-001 Table 3	JEDEC JESD22 A114-D
Charge Device Model	CDM	C3	ANSI/ESDA/JEDEC JS-002 Table 3	JEDEC JESD22 C101-C



Product Dimensions CGHV50200F (Package Type — 440217)

NOTES: (UNLESS OTHERWISE SPECIFIED)

1. INTERPRET DRAWING IN ACCORDANCE WITH ANSI Y14.5M-2009
2. ADHESIVE FROM LID MAY EXTEND A MAXIMUM OF .020 BEYOND EDGE OF LID
3. LID MAY BE MISALIGNED TO THE BODY OF PACKAGE BY A MAXIMUM OF .008 IN ANY DIRECTION
4. ALL PLATED SURFACES ARE GOLD OVER NICKEL

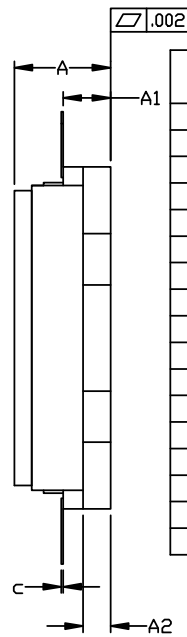
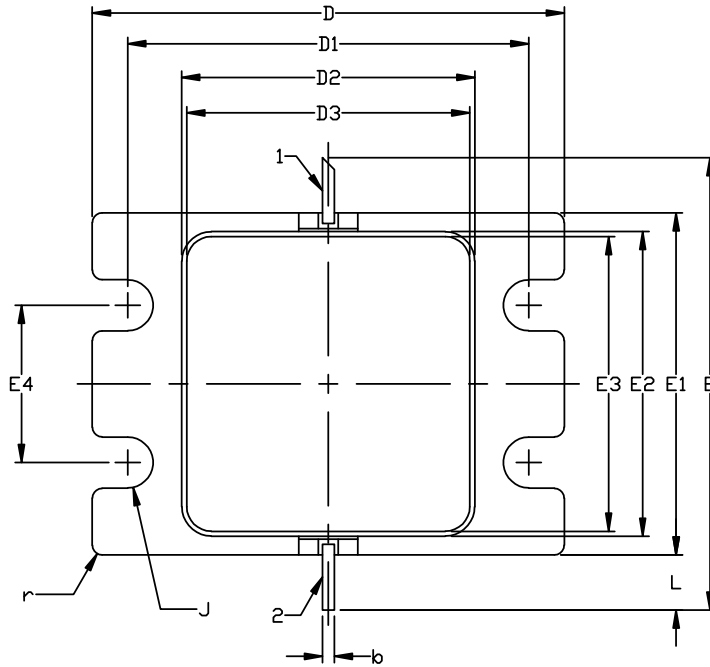

DIM	INCHES		MILLIMETERS		NOTES
	MIN	MAX	MIN	MAX	
A	0.188	0.198	4.78	5.03	
A1	0.088	0.100	2.24	2.54	2x
A2	0.049	0.061	1.24	1.55	
b	0.022	0.026	0.56	0.66	2x
c	0.002	0.006	0.05	0.15	
D	0.935	0.955	23.75	24.26	
D1	0.797	0.809	20.24	20.55	2x
D2	0.581	0.593	14.76	15.06	
D3	0.563	0.571	14.30	14.50	
E	0.906		23.01		REF
E1	0.679	0.691	17.25	17.55	
E2	0.604	0.616	15.34	15.65	
E3	0.586	0.594	14.88	15.09	
E4	0.309	0.321	7.85	8.15	2x
J	∅0.097	∅0.107	∅2.46	∅2.72	4x
L	0.090	0.130	2.29	3.30	2x
r	0.02 TYP		0.51 TYP		12x



Part Number System

CGHV50200F

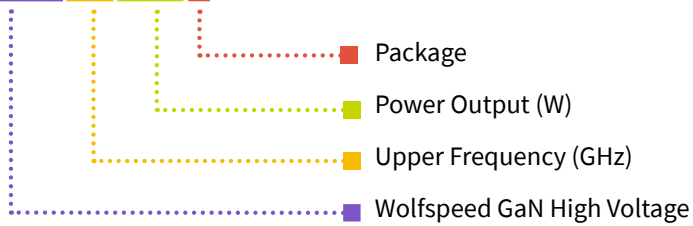

Table 1.

Parameter	Value	Units
Upper Frequency ¹	5.0	GHz
Power Output	200	W
Package	Flange	—

Note:

¹ Alpha characters used in frequency code indicate a value greater than 9.9 GHz. See Table 2 for value.

Table 2.

Character Code	Code Value
A	0
B	1
C	2
D	3
E	4
F	5
G	6
H	7
J	8
K	9
Examples:	1A = 10.0 GHz 2H = 27.0 GHz

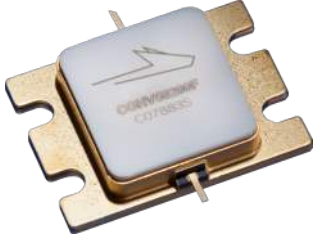
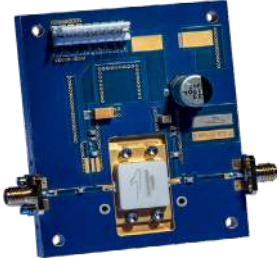

Product Ordering Information

Order Number	Description	Unit of Measure	Image
CGHV50200F	GaN HEMT	Each	
CGHV50200F-AMP	Test board with GaN HEMT installed	Each	

**For more information, please contact:**

4600 Silicon Drive
Durham, NC 27703 USA
Tel: +1.919.313.5300
www.wolfspeed.com/RF

Sales Contact
RFSales@wolfspeed.com

RF Product Marketing Contact
RFMarketing@wolfspeed.com

Notes & Disclaimer

Specifications are subject to change without notice. “Typical” parameters are the average values expected by Wolfspeed in large quantities and are provided for information purposes only. Wolfspeed products are not warranted or authorized for use as critical components in medical, life-saving, or life-sustaining applications, or other applications where a failure would reasonably be expected to cause severe personal injury or death. No responsibility is assumed by Wolfspeed for any infringement of patents or other rights of third parties which may result from use of the information contained herein. No license is granted by implication or otherwise under any patent or patent rights of Wolfspeed.

© 2013-2022 Wolfspeed, Inc. All rights reserved. Wolfspeed® and the Wolfstreak logo are registered trademarks and the Wolfspeed logo is a trademark of Wolfspeed, Inc.
PATENT: <https://www.wolfspeed.com/legal/patents>

The information in this document is subject to change without notice.