



## Crystal Clock Oscillator Specification

IQD Part No. + Packaging: LFSPX0050283RL3K

Würth Part No. 830205028309



### Description

- 32.768kHz output crystal oscillator in a ceramic package, hermetically sealed with a seam sealed metal lid  
Suitable for real time clock applications
- Model CFPS-104
- Model Issue number 4

### Frequency Parameters

- Frequency 32.7680kHz
- Frequency Stability  $\pm 25.00$ ppm
- Operating Temperature Range  $-40.00$  to  $85.00$ °C
- Ageing  $\pm 3$ ppm max per year

### Electrical Parameters

- Supply Voltage  $3.3V \pm 5\%$
- Current Draw 3.500mA

### Output Details

- Output Compatibility CMOS
- Drive Capability 15pF max
- Rise and Fall Time 50.0ns max
- Duty Cycle 40/60%

### Output Control

- Standby Operation:  
Logic '1' (>70% VS) to pad 1 enables oscillator output  
Logic '0' (<30% VS) to pad 1 disables oscillator output; when disabled the oscillator output goes to the high impedance state  
No connection to pad 1 enables oscillator output
- Start-up Time: 35ms max  
2ms typ to 90% of final amplitude (under ideal conditions @ 25°C)
- Standby Current: 20µA max, 1.7µA typ @ 25°C

### Environmental Parameters

- Storage Temperature Range:  $-55$  to  $125$ °C
- Shock: MIL-STD-883F, Method 2002.4: 1500G, 0.5ms, 3 times in each of 3 mutually perpendicular planes
- Vibration: MIL-STD-883F, Method 2007.3: 20G (20Hz-2000Hz), 1.52mm amplitude, 20mins in 3 mutually perpendicular planes (total 4hrs)

### Compliance

- RoHS Status (2011/65/EU) Compliant
- REACH Status Compliant
- MSL Rating (JEDEC-STD-033): Not Applicable

### Packaging Details

- Pack Style: RL3K Tape & reel in accordance with EIA-481-D  
Pack Size: 3,000

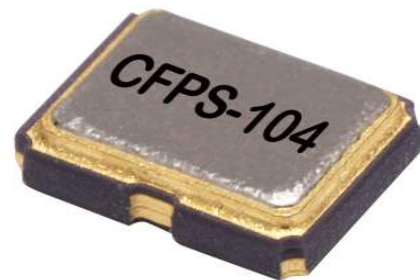

### Outline (mm)

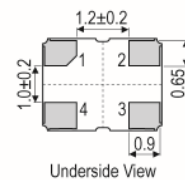
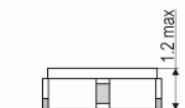
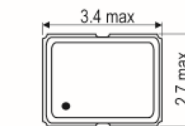

### Pad Connections

- Standby Operation
- GND
- Output
- +Vs

### Solder Pad Layout

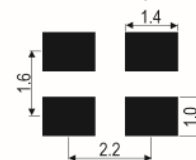

### Test Circuit

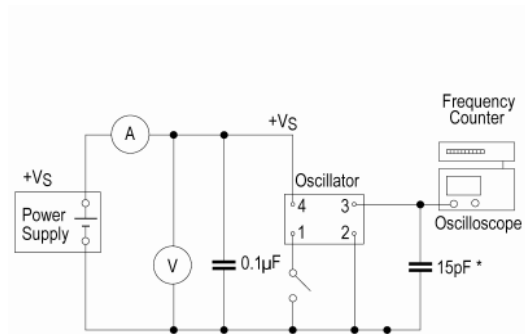

\* Inclusive of jigging and equipment capacitance

### CONTACT INFORMATION:

Würth Elektronik eiSos GmbH & Co. KG  
Max-Eyth-Str. 1, 74638 Waldenburg, Germany  
Tel: +49(0) 7942 945-0

Email: eiSos@we-online.de  
Web: www.we-online.com



## Crystal Clock Oscillator Specification

IQD Part No. + Packaging: LFSPXO050283RL3K

Würth Part No. 830205028309



- Alternative packing option available

### USEFUL LINKS

Toolbox:

[www.we-online.com/toolbox](http://www.we-online.com/toolbox)

Product Catalog:

[www.we-online.com/products](http://www.we-online.com/products)

### Wave Form

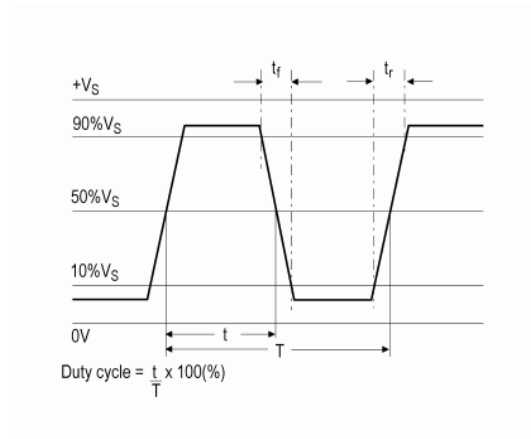

### CONTACT INFORMATION:

Würth Elektronik eiSos GmbH & Co. KG  
 Max-Eyth-Str. 1, 74638 Waldenburg, Germany  
 Tel: +49(0) 7942 945-0

Email: [eiSos@we-online.de](mailto:eiSos@we-online.de)  
 Web: [www.we-online.com](http://www.we-online.com)