



# Compact Power Line

## 48V DC Critical Power Solution



### Overview

The Compact Power Line platform is designed to provide highly reliable DC power for 48V distributed power architectures. A single shelf configuration provides up to 14kW of 48V output power in 1U high and mounts in 19-inch or 23-inch wide frames. The CPL product platform is easily expandable for future growth, and is a reliable DC power solution for mission-critical enterprise and telecommunications network equipment.

### Shelf Options

The CP product line provides several shelf options with common or split DC output configurations. There are two families of CPL shelves; one used with a Pulsar Edge controller, the other used without a controller or with a customer's own controller using industry standard PMBus/I<sup>2</sup>C communications. J85480S1 and J2014003 shelves have four slots for rectifiers or converters (PEMs) and use PMBus/I<sup>2</sup>C for communications. J2007001 and J2014004 shelves have four slots with an additional space for a full-feature Pulsar Edge Controller. The Pulsar Edge controller has secure Ethernet connectivity to facilitate remote network management to monitor and control rectifiers, batteries, and distribution. CPL is ideal for a broad range of applications requiring highly efficient 48V DC power.

### Rectifier Options

CPL family of rectifiers are single phase, constant power rectifiers with rear power entry that provide from 2000 Watts to 3500 Watts of highly reliable DC power. The class leading density, constant output power characteristics, extended temperature range, universal AC input, and compact size are key attributes that make this rectifier the right choice for your power needs. CPL converters share the same form factor as CPL rectifiers and provide wide range 40V-72V DC input and regulated 48-54V DC output. Airflow direction is front to rear.

### Pulsar Edge Controller

CPL family of products support the Pulsar Edge controller delivering large system intelligence in a small system form factor. Secure Ethernet connectivity with SNMP helps facilitate remote network management.

### Shelf Options

J85480S1 and J2007001 shelves provide 1RU rack density up to 11kW and support appliance connector (C13 or C19) AC connection options. The shelves support 2kW, 2.5kW and 2.7kW power supplies. Up to four modules can be installed in a single 1RU shelf. J2014003 and J2014004 shelves provide 1RU rack density up to 14kW with AC connectivity provided

by high reliability Molex connectors. Up to four modules can be installed in a single 1RU shelf. The shelves support 3kW and 3.5kW power supplies.

### Advantages

- Compact 48V DC distributed power system
- Efficiency approaching 97%
- Maximum power in minimal space
- Scalable to 80 kW
- Powering enterprise and telecommunications networks

# CPL Power Supplies

The CPL series of rectifiers are specifically designed to operate as an integral part of a complete distributed power system or can be easily integrated into an OEM design. The high-density, front-to-back airflow rectifier is designed for minimal space utilization and is highly expandable for future growth.



The power modules are available with many features including PoE isolation, RS485 communications bus for use with GE battery plant controllers in forming an energy reserve system and redundant I<sup>2</sup>C communications bus for use with a customer's embedded controller. This flexible and sophisticated feature set makes this front end power supply an excellent choice for power in a variety of application spaces.

## Applications

- Enterprise Networks
- OEM Telecom Equipment
- Power Over Ethernet
- VoIP/Soft Switches
- SAN/NAS/iSCSI Applications
- LAN/WAN/MAN Applications
- Indoor Wireless
- Routers and Switches
- Industrial
- Laser
- Broadcast
- Test and Measurement
- Mission Critical
- High Reliability

## Key Features

- Compact 1RU Form Factor
- PMBus Compliant Dual I<sup>2</sup>C and RS485 Serial Bus Communications
- Front Panel LED Indicators
- Internal Variable-Speed Fan Control
- Constant Power; 52 – 58 Vdc
- Programmable Output Voltage; 44 – 58 Vdc
- Universal AC Input
- PoE Compliant Versions Available
- CE Marked
- RoHS 6 Compliant
- Hot Pluggable

## Specifications: AC-DC Power Supplies

INPUT	2000	2725	3000	3500
Voltage Range - Low-Line - High-Line	120Vac Nominal (1200W) 208, 240, 277Vac Nominal		120Vac Nominal (1500W) 208, 240, 277Vac Nominal	
Input Frequency	47 – 63 Hz		47 – 66 Hz	
Input Current	11.9 Arms @ 110Vac 13.1 Arms @ 240Vac		15.5 Arms @ 110Vac 16 Arms @ 240Vac	
Inrush Transient	25Apk Typical		25Apk Typical	
Power Factor	0.98 from 50% to 100% Load		0.97 Min, 0.995 Typical	
Ride through (at <sup>1</sup> 240VAC, 25C)	1/2 Cycle Min, Full Cycle Typical			
<sup>2</sup> EMI/EMC	Exceeds FCC and CISPR22 (EN55022) - Class A			
High Accuracy AC Measurement	No		Optional	

<sup>1</sup> measurement starts at zero crossing of the ac voltage, and voltage devayed to 40V

<sup>2</sup> for loads below 1200W

## Specifications: AC-DC Power Supplies (Cont.)

OUTPUT	2000	2725	3000	3500
Voltage Adjust Range - Hardware set via Margin Pin - Set by either I <sup>2</sup> C for	44-58Vdc 42-58Vdc			
Rated Output Current - Low Line - High Line <sup>1</sup>	25 38.4	25 52.4	28.9 57.8	28.9 67.3
Rated Output Power - Low Line - High Line	1200W 2000W	1200W 2725W	1500W 3000W	1500W 3500W
Psophometric Noise	9mVrms			
Ripple (5Hz to 20MHz) - RMS - Peak to Peak	100mVrms max 250mVp-p max			
Over Voltage Protection - Delayed - Immediate	<60Vdc >65Vdc Three restart attempts are implemented within a 1 minute window prior to a latched shutdown.			
Over Temperature - Warning - Shutdown - Restart Attempt Hys-	5C 20C 10C			
PoE Isolation per IEEE 802.3	Optional		No	

<sup>1</sup>at full power @ 52V @ 200-240Vac

## Specifications: DC-DC Power Supplies

OUTPUT	2000	2500
Voltage Range	-40 to -72 Vdc	
Input Current	60Adc max	75Adc max
Inrush Current	60Adc max	100Adc max
Holdup Time	6ms	
EMI/EMC	Exceeds FCC and CISPR22 (EN55022) - Class A	
Voltage Default	54Vdc	
Voltage Adjust Range	44 - 58 Vdc	
Rated Output Current	0.1 to 37A	0.1 to 46.3A
Rated Output Power	2000W	2500W
Ripple (5Hz to 20MHz) - RMS - Peak to Peak	250mVrms 500mVpk-pk	
Over Voltage Protection - Delayed - Immediate	60Vdc 65Vdc	
Over Temperature - Warning - Shutdown	5C 20C	
PoE Isolation	Yes	Yes

## Specifications: All AC-DC Models and All DC-DC Models

MECHANICAL	
Length (in./mm)	13.85 / 351.2
Width (in./mm)	4 / 101.6
Height (in./mm)	1.63 / 41.4
Weight (lb / kg)	5 / 2.27

## Specifications: All AC-DC Models and All DC-DC Models (Cont.)









ENVIRONMENTAL	2000/2725	3000/3500
Operating Temperature <sup>1</sup>	-40°C to +75°C (-40°F to 167°F)	-40°C to +55°C (-40°F to 131°F)
Storage Temperature	-40°C to +85°C (-40°F to 185°F)	
Power De-Rating	> +55°C (derates @ 2% per °C)	
Relative Humidity	95% max, non-condensing	
Altitude	4,000m max (13,000 ft)	
Altitude De-Rating	Above 1524/5000 m/ft; 3962/13000 m/ft max (derates at 2C/1000ft)	
Audible Noise	55dBA, full load	

<sup>1</sup> designed to start at an ambient as low as -40°C but may not meet operational limits until above -5°C

GENERAL	2000/2725	3000/3500
Cooling	Internal variable speed fan cooled, microprocessor fan speed control	
Air Flow Direction	Front to Rear	
Efficiency (30-80% of FL, 240VAC @ 25°C)	94.5% Min 96.5% Typical	94.2% Min 96.1% Typical
Heat Dissipation	AC-DC 2000/2725 100 W/341 BTU @ 80% load 153 W/522 BTU @ 100% load  DC-DC 2000 -> 176W / 601 BTU 2500 -> 220W / 751 BTU	AC-DC 3000/3500 190 W/648 BTU @ 80% load 250 W/853 BTU @ 100% Load

SAFETY AND STANDARDS COMPLIANCE	2000/2725	3000/3500
Zone 4	Per Telcordia GR-63-CORE, all floors when installed in CPL shelf	
Safety	CE mark to Low Voltage Directive 2006/95/EC UL 609501-1 Recognized CAN/CSA C22.2 No. 60950-1-03 Certified VDE 0805-1 Licensed to IEC60950-1	
RoHS	Compliant to RoHS EU Directive 2002/95/EC	
EMC	FCC and CISPR22 (EN 55022) Class A	
ESD	EN/IEC 61000-4-2 Level 3	

## Front Panel LEDs

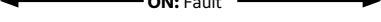
SYMBOL	ANALOG MODE	I <sup>2</sup> C MODE	RS485 MODE
		<b>ON:</b> Input OK <b>BLINKING:</b> Input Out of Limits	
		<b>ON:</b> Output OK <b>BLINKING:</b> Overload	
	<b>ON:</b> Over-temperature Warning	<b>ON:</b> Over-temperature Warning <b>BLINKING:</b> Service	<b>ON:</b> Over-temperature Warning
	 <b>ON:</b> Fault		<b>ON:</b> Fault <b>BLINKING:</b> Not Communicating

## Outline Drawings

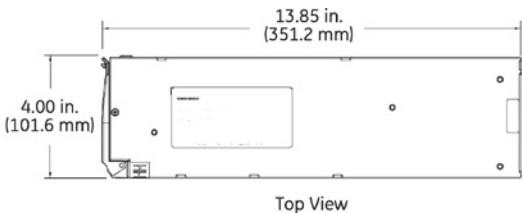
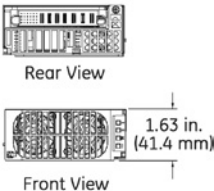
DIMENSIONS	
 <p>Top View</p>	 <p>Rear View</p> <p>Front View</p>

# Pulsar Edge Controller (For Applications in J2007001 and J2014004 shelves)

The CPL Pulsar Edge controller delivers large system intelligence in a small system form factor. This family of controllers functions as a network interface controller (NIC) and as a full-featured battery plant controller to the Compact Power Line (CPL) platform. Its thin modular plug-in form factor minimizes shelf space. The Pulsar Edge CP841A controller is utilized in bulk power applications in data centers and enterprise applications. Ethernet connectivity with SNMP facilitates remote network management access through its front-accessible RS232 or USB port and is aided by the EasyView2 graphical user interface.

As a battery plant controller, it provides a complete set of features to monitor and control rectifiers, batteries, and distribution. A flexible set of configurable inputs allow the CP841A to monitor a wide variety of system equipment and incorporate appropriate state information enabling a centralized point of management. The controller utilizes secure network management protocols allowing for advanced network supervision. GE Galaxy Manager\* software is the centralized visibility and control component of a comprehensive power management system designed to meet engineering, operations, and maintenance needs. The Galaxy Manager client-server architecture enables remote access to system controllers across the power network.



## Applications

- Telecommunications Networks
- Transmission Equipment
- Fiber in the Loop
- Routers/Switches
- Data Networks
- PBX
- Enterprise Networks - Voice, Data, PoE

## Key Features

### Remote Access and Features

- Integrated 10/100Base-T Ethernet Network
  - TCP/IP
  - SNMP V2c for management
  - SMTP for email
  - Telnet for command line interface
  - DHCP for plug-n-play
  - FTP for rapid backup and upgrades
  - HTTP for standard web pages and browsers
  - Compatible with Galaxy Manager and other management packages
  - Shielded RJ-45 interface referenced to chassis ground
- Password protected security levels: User, Super-User, Administrator for all access Ground-referenced RS232 system port ANSI T1.317 command-line interface
- Modem access support
  - Remote via external modem
  - Callback security
- EasyView2, Windows-based GUI software for local terminal or Modem access

### Secure Protocols:

- SNMP V3
- SSL
- SSH
- IPv6

### Standard System Features

- Monitor and control of more than 40 connected devices
  - Maximum of 32 rectifiers
  - Maximum of 6 distribution control cards
  - Robust RS485 system bus
- Standard and user defined system alarms
  - Alarm test
  - Assignable alarm severity: Critical, Major, Minor, Warning, and Record-only
- Rectifier management features
  - Automatic rectifier restart
  - Active Rectifier Management (energy efficiency)
  - Remote rectifier (on/off)
  - Reserve Operation
  - Automatic rectifier sequence control
  - N + X redundancy check

- Multiple Low Voltage Load and Low Voltage Battery Disconnect thresholds (4)
- Configuration, statistics, and history
  - All stored in non-volatile memory
  - Remote/local backup and restore of configuration data
- Industry standard defaults
  - Customer specific configurations available
- Remote/ local software upgrade
- Basic, busy hour, and trend statistics
- Detailed event history
- User defined events and derived channels

### Standard Battery Management Features

- Float/boost mode control
  - Manual boost
  - Manual timed boost locally, T1.317, and remotely initiated
  - Auto boost terminated by time or current
- Battery discharge testing
  - Manual (local/remote)
  - Periodic

### Pulsar Edge Controller Key Features (Cont.)

- Plant Battery Test (PBT) input driven
- Configurable threshold or 20% algorithm
- Graphical discharge data
- Rectifiers on-line during test
- Slope thermal compensation
  - High temperature
  - Low temperature
  - Step temperature
  - STC Enable/Disable, low temperature Enable/Disable
  - Configurable mV/°C slopes
- State of charge indication
- High temperature disconnect setting
- Reserve-time prediction
- Recharge current limit
- Emergency Power-Off input

### Integrated Monitoring Inputs/Outputs

- System plant voltage (accuracy  $\pm 0.5\%$ , resolution 0.01V)
- One system shunt (accuracy  $\pm 1\%$  full scale, resolution 1A)
  - Battery or load
  - Mounted in the return side of DC bus
- Up to 15 binary inputs
  - Six inputs close/open to battery
  - 9 input close/open to return (number is dependent upon number of output alarms)
  - User assignable
- Up to 5 user assignable Form-C output alarms (50VDC @ .3A)
- 1-Wire\* bus devices
  - Up to 16 temperature probes (QS873)
  - Up to 6 mid-string monitors (ES771)

### Galaxy Manager Compatible

- Centralized web server and database with multiple user access to live or managed data with drill down to problem details
- Monitor and control of more than 40 connected devices
- Management information from polling or alarms received from alarm traps from multiple sites are available on one screen via the inter/intranet
- Trend user selected data over time
- Automatic or manual report generation
- Standard engineering tools like reserve time calculators and cable voltage drop analyzer

## Specifications

CONTROLLER GENERAL	
Operating Voltage	$\pm 24$ Vdc, $\pm 48$ Vdc (Range: $\pm 18$ to $\pm 60$ Vdc)
Input Power	Less than 7W
Operating Temperature Range	-40°C to +75°C (-40°F to 167°F)
Storage Temperature Range	-40°C to +85°C (-40°F to 185°F)
Operating Relative Humidity	0 - 95% (non-condensing)
Physical Specifications	1.75 in. H, 0.75 in. W, 8.00 in. D; 0.5lb 45mm H, 20mm W, 204mm D; 227g

CONTROLLER AGENCY CERTIFICATIONS	
Radiated Emissions	FCC, Class B; EN 55022, Class B
Safety	UL Unlisted Component as Part of CPL or SPS Power System
RoHS	Compliant to RoHS EU Directive 2002/95/EC
EMC	FCC/EN55022 Class B, CISPR22 Level B
ESD	EN 61000-4-2 level 4

# Ordering Information – Compact Power Line

## 48V DC Critical Power Solution

The Compact Power Line platform is designed to provide highly reliable DC power for 48V distributed power architectures. When embedded into an OEM design, GE can assist with the integration into the OEM design. Otherwise an external shelf can be used to provide power. A single shelf configuration provides up to 14kW of 48V output power in 1U high and mounts in 19-inch or can be adapted to 23-inch wide frames. The CPL product platform is easily expandable for future growth by stacking multiple shelves. CPL is a reliable DC power solution for mission-critical enterprise and telecommunications network equipment.

The CPL product line provides several shelf options. J85480S1 and J2014003 shelves have four slots for either rectifiers or converters (PEMs). These shelves are primarily used without a controller or with a customer’s controller using PMBus or I<sup>2</sup>C communications. J2007001 and J2014004 shelves have four slots with space for a full-feature Pulsar Edge Network Interface Controller (NIC). The Pulsar Edge controller has secure Ethernet connectivity with SNMPv3 to facilitate remote network management to monitor and control rectifiers, batteries, and distribution. These shelves are used with either shelf mounted distribution or external distribution panels for small battery plant applications.

## Simplified Shelf Identification Matrix

SHELF SERIES	USAGE	COMMUNICATIONS	POWER SUPPLY INPUT CONNECTOR
J85480S1	CP2000/CP2725	PM Bus/I <sup>2</sup> C	Rear
J2007001	CP2000/CP2725	RS485	Rear
J2014004	CP3000/CP3500	RS485	Rear
J2014003	CP3000/CP3500	PM Bus/I <sup>2</sup> C	Rear
Embedded Only	CP3000AC-Fxx	PM Bus/I <sup>2</sup> C or RS485	Front
Embedded Only	CP2500DC-Fxx	PM Bus/I <sup>2</sup> C or RS485	Front

### Features – Model J85480S1 and J2014003

- Fits into a standard 19” rack
- Two DC Outputs may be common or split. Each output bus is rated for 100A with two-hole lug landings for 2 AWG wire.
- Choose between IEC-320 C13 or C19 or other AC input connections
- Analog or dual/redundant I<sup>2</sup>C communications
- Adjustable mounting ears for near flush front or multiple set back positions



J2007 or J2014004  
Rectifier Shelf



J2007 Converter Shelf



J85480 or J2014003  
Rectifier Shelf



J85480 Converter Shelf

### Features – Model J2007001 and J2014004

- Fits into a standard 19” rack
- Single DC output rated for 200A with two-hole lug landings for up to 2/0 AWG cable
- Choose between IEC-320 or Molex Mini-Fit SR for AC input  
Single, dual or quad input feeds
- RS485 communications
- Adjustable mounting ears with multiple set back positions
- Up to 3 shelves may be interconnected with bus straps for DC outputs for a 600A system
- Plug-N-Play CP841A controller with front access craft port, rear access LAN and alarm connections
- Select Shelves include distribution modules



# Outline Drawings - J85480S1 Shelves

## DIMENSIONS

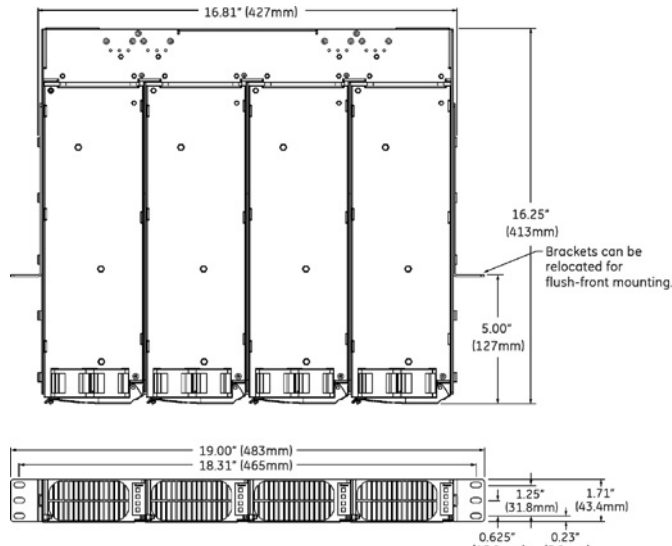

## J8540S1 Converter Shelf Options

LIST	MAX POWER	DC INPUT PLUG	DC OUTPUT		MAX POWER SUPPLY	FEATURES		ORDER CODE
			BUS	TERMINATION		SETPOINT	OTHER	
14	10kW	Qty 2 (1 per 2 rectifiers)	Split	Double Hole Lugs 1/4in x 5/8in Spacing	CP2500DC	(+) 48Vdc	POE, Analog, I <sup>2</sup> C	CC109124764



## J85480S1 Rectifier Shelf Options

LIST	MAX POWER	AC INPUT PLUG	DC OUTPUT		MAX RECTIFIER SIZE	FEATURES		ORDER CODE
			BUS	TERMINATION		SETPOINT	OTHER	
20	11kW	IEC-320, C19	Common	DH Lugs	CP2725	(+) 54Vdc	Analog, I <sup>2</sup> C	CC109147344
21			Split			-54Vdc		CC109147328
23	8kW	IEC-320, C13	Common		CP2000	(+) 54Vdc	POE, Analog, I <sup>2</sup> C	CC109150447



### Notes

- Split shelves L21 and Vout (-) is split, however Vout (+) is paralleled among the 4 rectifiers. Vout (+) should be grounded.
- All lists, up to 2 shelves can be paralleled for a single I<sup>2</sup>C line. Up to eight shelves may be paralleled for current shared power delivery.
- All lists, shelf configured set point ensures inter-operability among all rectifiers from CP2000 to CP2725. Rectifiers will proportionately current share relative to their output power capacity.
- All Shelves are RoHS 6 compliant. Order should reflect J85480S1LxxZ where xx is the list number and Z indicates compliance to RoHS 6.



# Outline Drawings - J2014003 Shelves

## DIMENSIONS

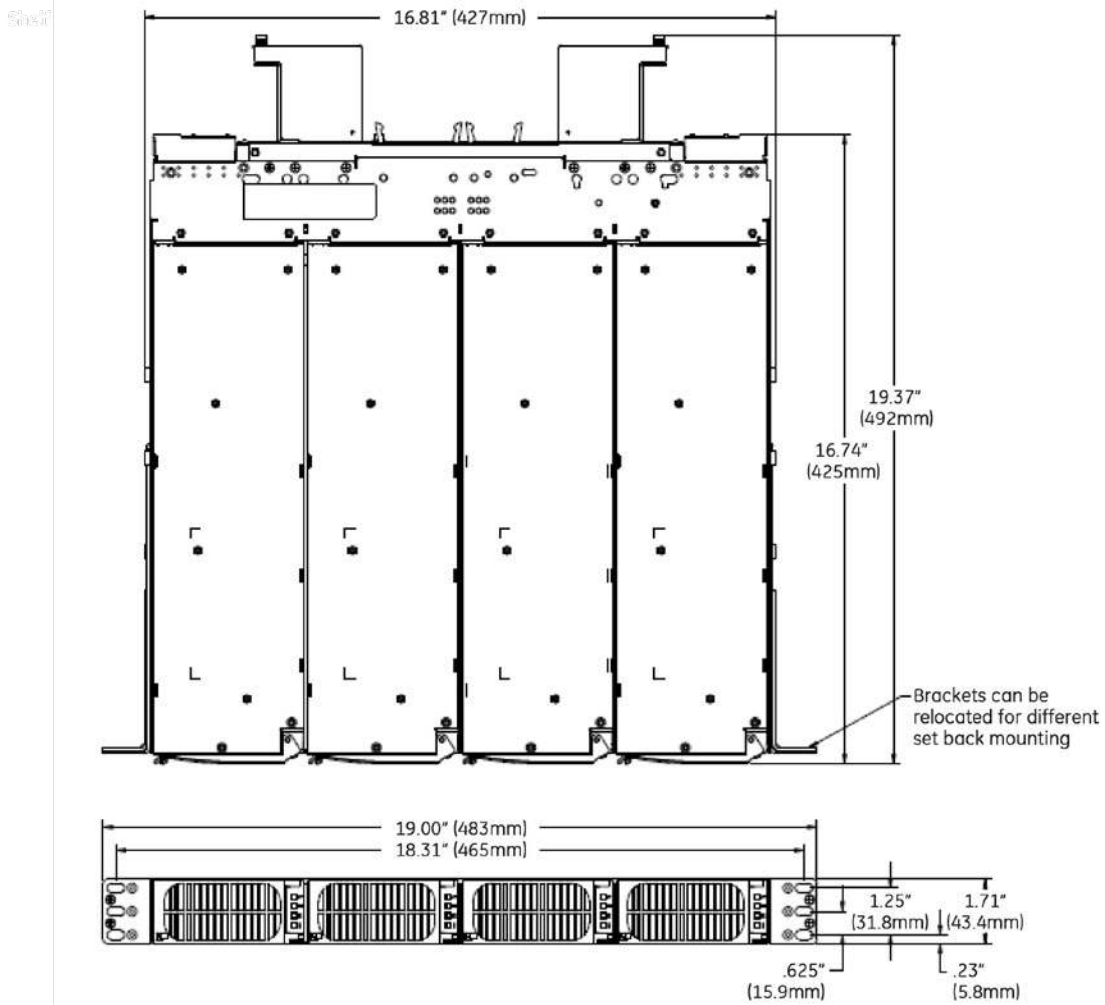

## J2014003 Rectifier Shelf Options

LIST	MAX POWER	AC INPUT CONNECTOR	DC OUTPUT		FEATURES		OTHER	ORDER CODE
			BUS	TERMINATION	RECTIFIER SIZE	SET POINT		
1	14kW	Molex Mini-Fit Sr	Common	Double Hole Lugs 1/4in x 5/8in Spacing	CP3000/ CP3500	54Vdc	Analog I <sup>2</sup> C	150040608

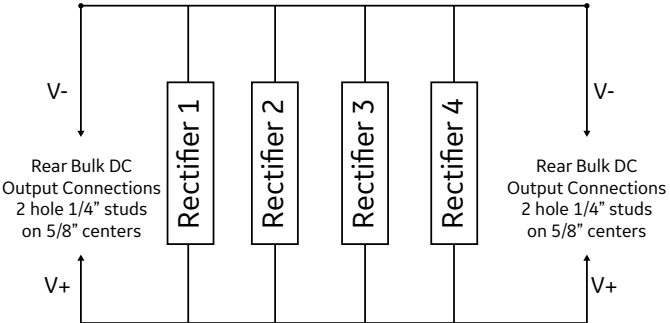

## DC Output Types: Common Output Bus for Terminal Lug Connection

DESCRIPTION	SCHEMATIC
<ul style="list-style-type: none"> <li>Each Lug Connection rated for 100A with 2 gauge wire (200A for shelf)</li> </ul>	

## DC Output Types: Split Output Bus for Terminal Lug Connection

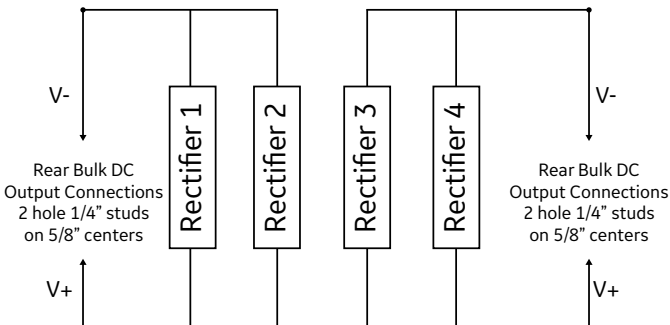
DESCRIPTION	SCHEMATIC
<ul style="list-style-type: none"> <li>Vdc (-) has Split buses Vdc(+) is common to both sections.</li> <li>Each bus may be independently controlled</li> <li>Multiple shelves may not be paralleled together.</li> <li>Each Lug Connection rated for 100A with 2 gauge wire (200A for shelf)</li> </ul>	

## J1 Communication Signals – J85480S1 (J1 Connector – Pin Out)

PIN	SIGNAL	PIN	SIGNAL	PHOTO
1	POWER_CAP_1	16	SDA_1	
2	POWER_CAP_2	17	Fault	
3	POWER_CAP_3	18	Alert#_0	
4	POWER_CAP_4	19	Enable side B	
5	MOD_PRES_1	20	Logic_GRD	
6	MOD_PRES_2	21	Enable Side A	
7	MOD_PRES_3	22	Logic_GRD	
8	MOD_PRES_4	23	Alert#_1	
9	PFW_1	24	5VA	
10	PFW_2	25	OTW	
11	PFW_3	26	Reset	
12	PFW_4	27	Iso. barrier n/c	
13	SCL_0	28	Iso. barrier n/c	
14	SCL_1	29	Shelf_Addr_B	
15	SDA_0	30	Shelf_Addr_A	

Control Interface cable (part # CC848854034)

## J2 Communication J85480S1 and J2014003 Shelves (J2 Connector – Pin Out)

PIN	SIGNAL	PIN	SIGNAL	PHOTO
1	SCL_0	8	Alert#_1	
2	SCL_0	9	Isolation n/c	
3	SDA_0	10	Isolation n/c	
4	SDA_1	11	Ishare - B	
5	Alert#_0	12	Ishare - A	
6	5VA	13	8V_INT - B	
7	Logic_GRD	14	8V_INT - A	

Shelf-to-shelf cable connection (part # CC848848952)

## J1 Communication Signals – J2014003 Shelves (J1 Connector – Pin Out)

PIN	SIGNAL	PIN	SIGNAL	PHOTO
1	POWER_CAP_1	16	SDA_1	
2	POWER_CAP_2	17	Fault	
3	POWER_CAP_3	18	Alert#_0	
4	POWER_CAP_4	19	Enable side B	
5	MOD_PRES_1	20	Logic_GRD	
6	MOD_PRES_2	21	Enable Side A	
7	MOD_PRES_3	22	Logic_GRD	
8	MOD_PRES_4	23	Alert#_1	
9	PFW_1	24	5VA	
10	PFW_2	25	OTW	
11	PFW_3	26	Reset	
12	PFW_4	27	Iso. barrier n/c	
13	SCL_0	28	Iso. barrier n/c	
14	SCL_1	29	VProg	
15	SDA_0	30	Rack ID	

Control Interface cable (part # CC848854034)

# Outline Drawings - J2007001 Shelves

## DIMENSIONS

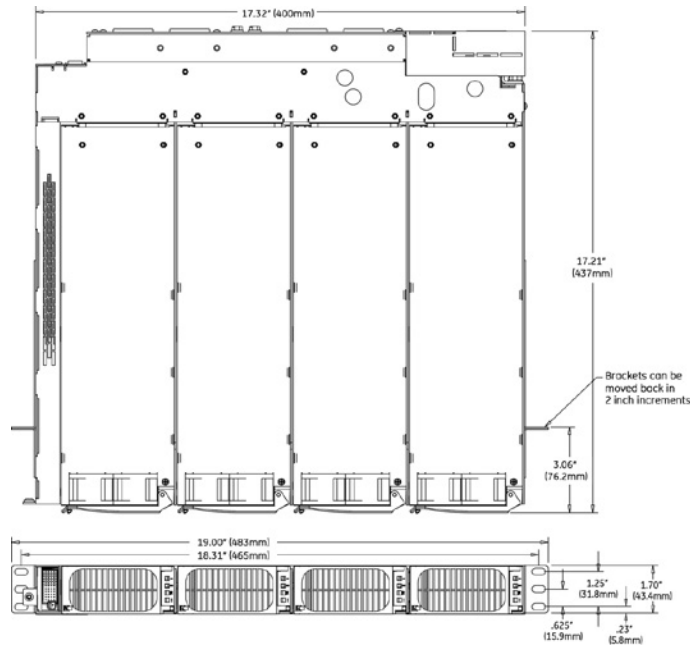

## J2007001L14 DC PEM Shelf Options

LIST	MAX POWER	DC INPUT PLUG	DC OUTPUT		MAX POWER SUPPLY	FEATURES		ORDER CODE
			BUS	TERMINATION		SETPOINT	OTHER	
14	10kW	2 x 1/4-20 x 5/8 in DH Lug	Common	2 x 1/4-20 x 5/8 in DH Lug	CP2500DC	Variable, set by Edge Controller	RS485	CC109157657

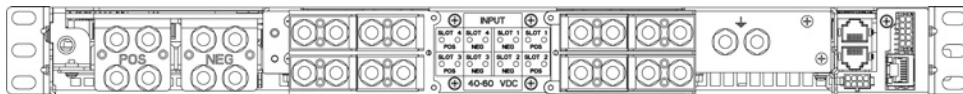

## J2007001 Rectifier Shelf Options

LIST	MAX RECTIFIER SIZE	AC INPUT	DC OUTPUT	REAR VIEW OF SHELF
3	2725 Watts	Single AC feed (terminal blocks for 6ga wire and 3/4" conduit fitting)	DC output bus is rated for 200A for two 2ga or one 2/0 gauge two-hole lugs (1/4-20 studs on 5/8" centers).	DC Output Bus AC Signal
4	2725 Watts	Individual feed (Molex Mini-Fit SR)		
6	2725 Watts	Individual feed (IEC-320 C19 Cords)		

- Notes:
1. CP841A Pulsar Edge Controller ships separately.
  2. Up to 3 shelves may be interconnected.

# Outline Drawings - J2014004 Shelves

## DIMENSIONS

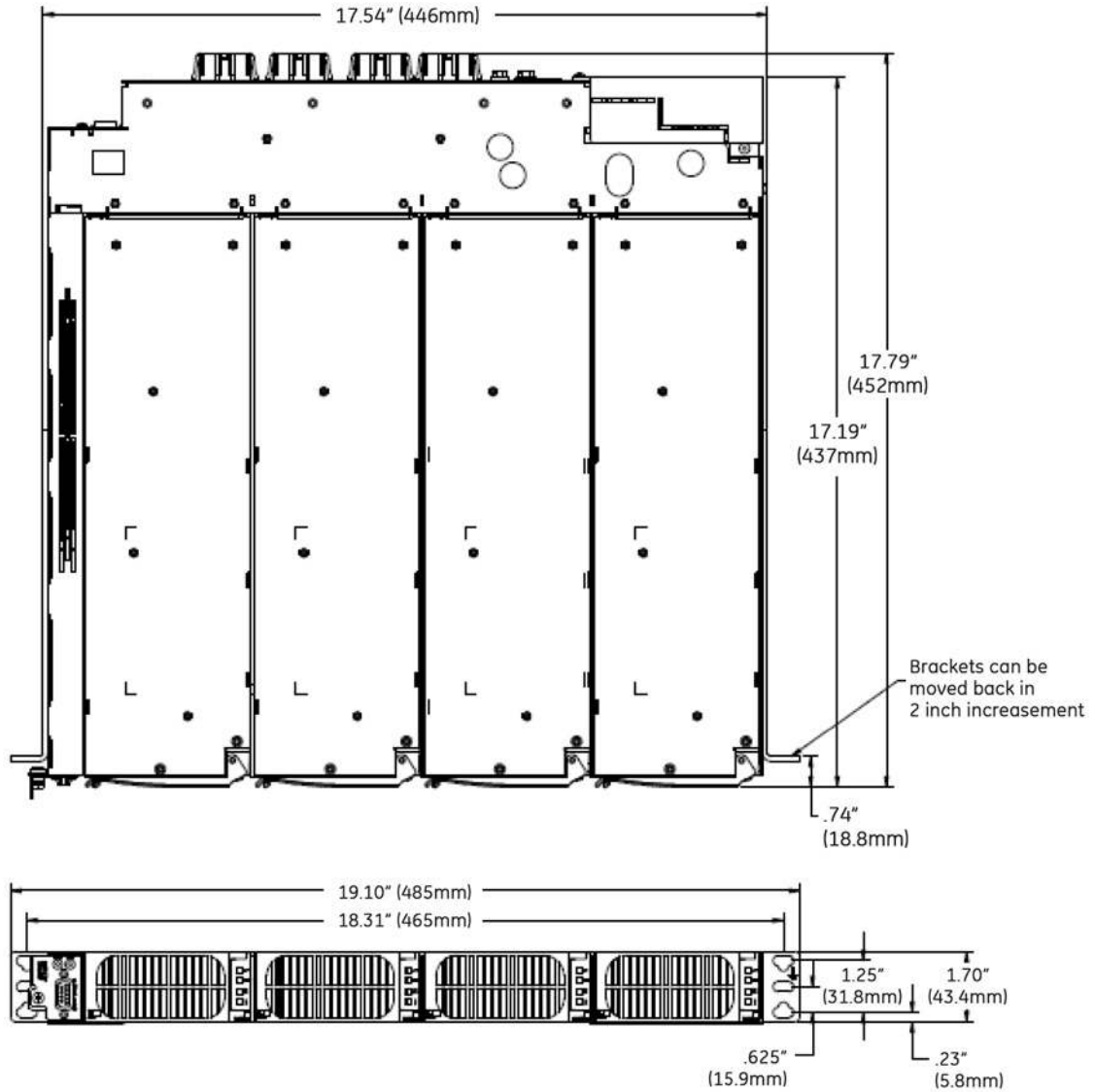

## J2014004 Rectifier Shelf

LIST	MAX POWER	AC INPUT PLUG	DC OUTPUT		MAX POWER SUPPLY	FEATURES		ORDER CODE
			BUS	TERMINATION		SETPOINT	OTHER	
1	14kW	Molex Mini Fit Sr	Common	2pr x 1/4-20 x 5/8 in DH Lug	CP3500	Variable, set by Edge Controller	RS485	150040609

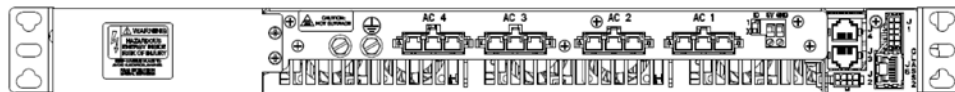

Notes: 1. CP841A Pulsar Edge Controller ships separately. 2. Up to 3 shelves may be interconnected.

# J2007001 and J2014004 Shelves System Controller Overview

EDGE CONTROLLER		PHOTO
CP841A_3C3R_S	J1 has 3 alarm inputs with a common return and 3 output relays; Power Major, Power Minor, 1 Selectable	

## Communication Signals for J2007001 and J2014004 Shelves

J1 provides alarm outputs and inputs based on the controller installed (see table on next page). Inputs are “Dry”, no voltage, contact Closures or Opens to a common return on pin 6. Outputs are relay contacts. Both input and output alarms are customer defined on the controller’s web pages.

J2 provides alarm inputs (see table on next page). Alarm inputs are contact Closures or Opens to the non-grounded side of the dc bus [-48V]. Pins 6, 7, 8 provide -48V for these alarm inputs.

J3 battery thermal probe (QS873A) or battery mid-string voltage monitor (ES771) with battery thermal probe.

J4 shelf to shelf communication connection J5 LAN/Ethernet.

J7 provides distribution control for shelves with external distribution. See table on next page.

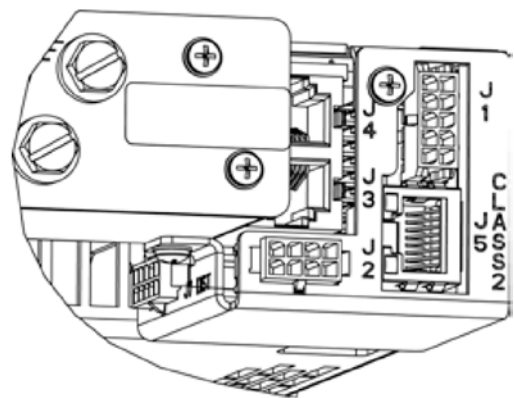

## J1 Connector – Pin Out

PIN	SIGNALS FOR SPS841A_3C3R	SIGNALS FOR SPS841A_015R
1	ALM1 Input	Alarm Relay 3 Rtn
2	ALM2 Input	Alarm Relay 2 Rtn
3	Alarm Relay 1 Rtn	Alarm Relay 1 Rtn
4	Power Minor Rtn	Power Minor Rtn
5	Power Major Rtn	Power Major Rtn
6	ALM1, 2, 6C RTNS	Alarm Relay 3
7	ALM6 Input	Alarm Relay 2
8	Alarm Relay 1	Alarm Relay 1
9	Power Minor	Power Minor
10	Power Major	Power Major

## J2 Connector

PIN	SIGNAL
1	ALM6 Input
2	-
3	ALM3 Input
4	ALM4 Input
5	ALM5 Input
6	-48V
7	-48V
8	-48V

## J7 Connector

PIN	SIGNAL
1	FAJ
2	Coil Rtn
3	LVD_NC
4	LVD_NO
5	Shunt-
6	OS
7	Coil1
8	Coil2
9	LVD Status Rtn
10	Shunt+

## Battery Monitoring

Temperature/Voltage probes are needed for battery monitoring. They are connected to each battery or battery string to provide slope thermal compensation, temperature alarms and voltage imbalance alarms. Refer to ordering guide for diagram and part numbers.



# CP2000/CP2725 Shelves

## J85480S1 Family Shelves Ordering Guide

MOUNTING BRACKETS	
1U bracket for 23" frame mount	CC848844803
2U bracket for 23" frame mount	848683009
Wall mount bracket	CC848864504

COMMUNICATION CABLES	
10' Communication Cable (J1)	CC848854034
Shelf to shelf communication cable	CC848848952

AC INPUT, DC OUTPUT CABLES	
C13 plug with 5-15P plug, 10'	CC848776105
C13 plug with L6-20P plug, 10'	CC848820317
C13 plug, unterminated, 10'	847861192
C19 plug, with 5-15P plug, 8'	CC848850792
C19 plug, with L6-20P plug, 8'	CC848850842
C19 plug, unterminated, 8'	CC848847368
DC output cable, 2 GA, 10'	848748987

RECTIFIER SHELF OPTIONS	
List 20	CC109147344
List 21	CC109147328
List 23	CC109150447

RECTIFIER	
CP2000AC54TEZ	CC109158440
CP2000AC54TEP	CC109167565
CP2725AC54TEP	CC109167532
CP2725AC54TEZ	CC109149423

RECTIFIER SLOT FILLER	
Central Office White	CC848822263

## J85480S1 Converter Shelf Ordering Guide

MOUNTING BRACKETS	
1U bracket for 23" frame mount	CC848844803
Wall mount bracket	CC848864504

DC INPUT CABLES	
DC input cable, 10 GA, 4'	CC848794908

DC OUTPUT CABLES	
DC output cable, 2 GA 10'	848748987
DC Bus for 1/4" Faston Connections (2 required)	CC848886192

CONVERTER SHELF OPTIONS	
List 14	CC109124764

CONVERTER (PEM) OPTIONS	
CP2000DC54PEZ	CC109162104
CP2500DC54PEZ	CC109170528

RECTIFIER SLOT FILLER	
Central Office White	CC848822263

# CP2000/CP2725 Shelves (Cont.)

## J2007001 Family Shelves Ordering Guide

MOUNTING BRACKETS		ALARM AND COMMUNICATION CABLES		AC INPUT, DC OUTPUT CABLES	
1U bracket for 23" frame mount	CC848844803	15' Alarm or distribution cable (J1 or J7)	CC848865980	C19 plug, with 5-15P plug, 8'	CC848850792
2U bracket for 23" frame mount	848683009	50' Alarm or distribution cable (J1 or J7)	CC848817651	C19 plug, with L6-20P plug, 8'	CC848850842
Wall mount bracket	CC848864504	150' Alarm or distribution cable (J1 or J7)	CC848817668	C19 plug, unterminated, 8'	CC848847368
		15' Alarm input cable (J2)	CC848853614	Molex Mini-Fit SR, unterminated, 8awg, 10' (2 cables provided)	848710711
		Shelf to shelf communication cable (J3, J4)	CC848847780	DC output cable, 2ga, 10'	848748987
				DC Bus Bar Strap (2 required)	CC848844324

CONTROLLER		RECTIFIER		RECTIFIER SLOT FILLER		RECTIFIER SHELF OPTIONS	
CP841A_3C3R_S	150032047	CP2000AC54TEZ	CC109158440	Central Office White	CC848822263	List 3	CC109147542
Slot Filler	CC848847871	CP2000AC54TEP	CC109167565			List 4	CC109140043
		CP2725AC54TEP	CC109167532			List 6 (Shown)	CC109140027 (Rohs5) 150047190 (Rohs6)
		CP2725AC54TEZ	CC109149423				

## J2007001L014 Converter Shelf Ordering Guide

MOUNTING BRACKETS		DC OUTPUT CABLES	
1U bracket for 23" frame mount	CC848844803	DC output cable, 2 GA 10'	848748987
Wall mount bracket	CC848864504	DC Bus for 1/4" Faston Connections (2 required)	CC848886192

CONVERTER SHELF OPTIONS		CONVERTER (PEM) OPTIONS	
List 14	CC109157657	CP2000DC54PEZ	CC109162104
		CP2500DC54PEZ	CC109170528

CONTROLLER		RECTIFIER SLOT FILLER		RECTIFIER SLOT FILLER	
CP841A_3C3R_S	150032047	Central Office White	CC848822263	Central Office White	CC848822263
Slot Filler	CC848847871				

# CP3000/CP3500 Shelves

## J2014003 Shelf Ordering Guide

MOUNTING BRACKETS	
1U bracket for 23" frame mount	CC848844803
2U bracket for 23" frame mount	848683009
Wall mount bracket	CC848864504

AC INPUT, DC OUTPUT CABLES	
Molex Mini-Fit SR, unterminated, 8awg, 36" (Single Cable)	CC848763301
Molex Mini-Fit SR, unterminated, 8awg, 10' (Single Cable)	CC848793026
Molex Mini-Fit SR, unterminated, 8awg, 10' (2 cables provided)	848710711
DC output cable, 2ga, 10'	848748987
DC Bus Bar Strap (2 required)	CC848844324

RECTIFIER	
CP3000AC54TEZ	150033916
CP3000AC54TECZ	150041904
CP3500AC54TEZ	150030396
CP3500AC54TECZ	150041901

RECTIFIER SLOT FILLER	
Central Office White	CC848822263

RECTIFIER SHELF OPTIONS	
J2014003001 List 1	150040608

## J2014004 Shelf Ordering Guide

MOUNTING BRACKETS	
1U bracket for 23" frame mount	CC848844803
Wall mount bracket	CC848864504

ALARM AND COMMUNICATION CABLES	
15' Alarm or distribution cable (J1 or J7)	CC848865980
50' Alarm or distribution cable (J1 or J7)	CC848817651
150' Alarm or distribution cable (J1 or J7)	CC848817668
15' Alarm input cable (J2)	CC848853614
Shelf to shelf communication cable (J3, J4)	CC848847780

AC INPUT, DC OUTPUT CABLES	
Molex Mini-Fit SR, unterminated, 8awg, 36" (Single Cable)	CC848763301
Molex Mini-Fit SR, unterminated, 8awg, 10' (Single Cable)	CC848793026
Molex Mini-Fit SR, unterminated, 8awg, 10' (2 cables provided)	848710711
DC output cable, 2ga, 10'	848748987
DC Bus Bar Strap (2 required)	CC848844324

SHELF OPTIONS	
List 1	CC109157657

RECTIFIER	
CP3000AC54TEZ	150033916
CP3000AC54TECZ	150041904
CP3500AC54TEZ	150030396
CP3500AC54TECZ	150041901

RECTIFIER SLOT FILLER	
Central Office White	CC848822263

RECTIFIER SHELF OPTIONS	
J2014004001 List 1	150040609

CONTROLLER	
CP841A_3C3R_S	150032047
Slot Filler	CC848847871

BATTERY MANAGEMENT ACCESSORIES	
A: QS873A Thermal Probe	CC109142980
B: 10' probe to controller wireset	CC848817024
C: 1' probe to probe wireset	CC848822560
C: 5' probe to probe wireset	848719803
C: 10' probe to probe wireset	CC848822321
ES771A Voltage Monitor Card	108958422
D: 2 1/2' ES771A to probe wireset	CC848791517
D: 6' ES771A to probe wireset	CC848797290
D: 10' ES771A to probe wireset	848719829
G: 4' ES771A to ES771A or controller wireset	CC848791500
G: 10' ES771A to ES771A or controller wireset	848652947

PHOTO

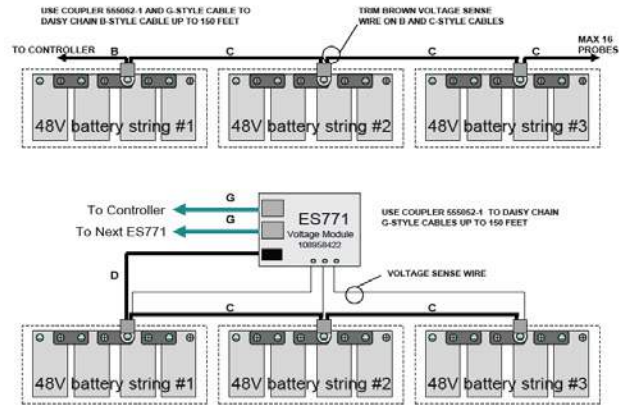

## Specifications

### Rectifiers

POWER MODULE	OUTPUT POWER/INPUT VOLTAGE	OUTPUT VOLTAGE	PROTECTION	PHYSICAL
CP2000AC54TEZ/TEP	2000W / 200-277VAC 1200W / 100-120VAC	Hardware set 44 - 58Vdc Software set 42 - 58Vdc	15A breaker, 14 gauge wire	Length: 13.85"/351.8mm Width: 4.00"/101.6mm Height: 1.66"/42.2mm Weight: 4.6lb/2.1kg
CP2500DC54PEZ	2500W / 40-72VDC		70A breaker, 8 gauge wire	
CP2725AC54TEZ/TEP	2725W / 200-277VAC 1200W / 100-120VAC		20A breaker, 12 gauge wire	
CP2000DC54-PEZ	2000W / 40-72VDC		60A breaker, 8 gauge wire	
CP3000AC54TEZ/TECZ	3000W / 200-277VAC 1500W / 100-120VAC		30A breaker, 10 gauge wire	
CP3500AC54TEZ/TECZ	3500W / 200-277VAC 1500W / 100-120VAC		20A breaker, 12 gauge wire	

Notes: PE suffix denotes PoE compliance. Z suffix denotes RoHS 6 compliance. TE suffix denotes Total Efficiency\* architecture.

### Shelves

MECHANICAL	J85480S-1	J2014003	J2007001L014	J2007001	J2014004
Height	1.71 inches/43.4mm	1.71 inches/43.4mm	1.71 inches/43.4mm	1.71 inches/43.4mm	1.71 inches/43.4mm
Width (with mounting ears)	19 inches/483mm	19 inches/483mm	19 inches/483mm	19 inches/483mm	19 inches/483mm
Depth	16.25 inches/413mm	17.25 inches/438mm	19.5 inches/497mm	17.06 inches/433mm	16.9 inches/429mm
Weight (without rectifiers)	9.25lbs/4.2kg	9.5lbs/4.3kg	9.5lb/4.3kg	8.75lbs/4.0kg	9lbs/4.1kg

Note: dimensions of specific model numbers may vary

## Reliability

- Proven field performance
- Advanced alarming
- N+1 modularity

## Intelligence

- Industry leading controller features
- Ethernet interface for remote access
- Centralized network management

## Investment Protection

- Minimal space requirements
- Versatile configurations
- Efficient operation

## On Time Delivery

- Standard building blocks
- 8-16 week availability
- 24/7 support

## Management Visibility

Galaxy Manager\* software is the centralized visibility and control component of a comprehensive power management system designed to meet engineering, operations and maintenance needs. The Galaxy Manager client-server architecture enables remote access to system controllers across the power network.

- Dashboard display with one-click access to management information database
- Trend analysis
- Scheduled or on demand reports
- Fault, configuration, asset, and performance management

## Training

GE offers on-site and classroom training options based on certification curriculum. Technical training can be tailored to individual customer needs. Training enables customers and partners to more effectively manage and support the power infrastructure. We have built our training program on practical learning objectives that are relevant to specific technologies or infrastructure design objectives.

## Service & Support

GE field service and support personnel are trusted advisors to our customers – always available to answer questions and help with any project, large or small. Our certified professional services team consists of experts in every aspect of power conversion with the resources and experience to handle large turnkey projects along with custom approaches to complex challenges. Proven systems engineering and installation best practices are designed to safely deliver results that exceed our customers' expectations.

## Warranty

GE is committed to providing quality products and solutions. We have developed a comprehensive warranty that protects you and provides a simple way to get your products repaired or replaced as soon as possible.

For full warranty terms and conditions please go to [www.gecriticalpower.com](http://www.gecriticalpower.com).