

MAX14950

Quad PCI Express Equalizer/Redriver

General Description

The MAX14950 is a quad equalizer/redriver designed to improve PCI Express® (PCIe) signal integrity by providing programmable input equalization at its receiver and programmable redrive circuitry. The output circuitry re-establishes deemphasis lost on the board and compensates for circuit-board loss. The device permits optimal placement of key PCIe components. The device is useful with stripline, microstrip printed circuits, and balanced 100Ω cable.

The device is tailored for PCIe and features electrical idle and receiver detection on each channel. It is optimized for PCIe Gen III (8.0GT/s) and Gen II (5.0GT/s) data rates, while still handling Gen I (2.5GT/s).

The MAX14950 is available in a small, lead-free, 42-pin (3.5mm x 9.0mm) TQFN package for optimal layout and minimal space requirements. The device is specified over the 0°C to +70°C operating temperature range.

Applications

Servers
Storage
Desktop Computers/Notebook PCs
Communications Switchers

Features

- ◆ **Optimized for Generation III (8.0GT/s) and Generation II (5.0GT/s) with Generation I (2.5GT/s) Compatibility**
- ◆ **Receive Detection Permits Completely Transparent, Software-Free Operation**
- ◆ **Equalization Permits Placement of Up to 30in FR4**
- ◆ **PCIe Gen III (8.0GT/s)-Compliant Input/Output Return Loss**
- ◆ **Electrical Idle Detection**
- ◆ **Very Low Latency: 160ps (typ) Propagation Delay**
- ◆ **Random Jitter $\leq 0.5\text{psRMS}$ (typ)**
- ◆ **Deterministic Jitter $\leq 10.5\text{psP-P}$ (typ)**
- ◆ **Four-Level-Programmable Input Equalization**
- ◆ **Eight-Level-Programmable Output Emphasis**
- ◆ **On-Chip 50Ω Input/Output Terminations**
- ◆ **Single +3.3V Supply Operation**
- ◆ **$\pm 5\text{kV}$ Human Body Model (HBM) Protection On All Pins**
- ◆ **Space-Saving: 3.5mm x 9.0mm TQFN Package**
- ◆ **Pin Compatible with MAX4950 PCIe Generation II Redriver/Equalizer**

Ordering Information

PART	TEMP RANGE	PIN-PACKAGE
MAX14950CTO+	0°C to +70°C	42 TQFN-EP*

+Denotes a lead(Pb)-free/RoHS-compliant package.

*EP = Exposed pad.

PCI Express is a registered trademark of PCI-SIG Corp.

For pricing, delivery, and ordering information, please contact Maxim Direct at 1-888-629-4642, or visit Maxim's website at www.maximintegrated.com.

MAX14950

Quad PCI Express Equalizer/Redriver

ABSOLUTE MAXIMUM RATINGS

(Voltages referenced to GND.)

VCC	-0.3V to +4V
All Other Pins (Note 1)	-0.3V to (VCC + 0.3V)
Continuous Current IN_P/IN_N	±30mA
Peak Current IN_P/IN_N (pulsed for 1μs, 1% duty cycle)	±100mA
Continuous Power Dissipation (TA = +70°C)	
TQFN (derate 34.5mW/°C above +70°C)	2759mW

Operating Temperature Range	0°C to +70°C
Storage Temperature Range	-55°C to +150°C
Junction Temperature	+150°C
Lead Temperature (soldering, 10s)	+300°C
Soldering Temperature (reflow)	+260°C

Note 1: All I/O pins are clamped by internal diodes.

PACKAGE THERMAL CHARACTERISTICS (Note 2)

TQFN

Junction-to-Ambient Thermal Resistance (θJA)	29°C/W
Junction-to-Case Thermal Resistance (θJC)	2°C/W

Note 2: Package thermal resistances were obtained using the method described in JEDEC specification JESD51-7, using a four-layer board. For detailed information on package thermal considerations, refer to www.maximintegrated.com/thermal-tutorial.

Stresses beyond those listed under "Absolute Maximum Ratings" may cause permanent damage to the device. These are stress ratings only, and functional operation of the device at these or any other conditions beyond those indicated in the operational sections of the specifications is not implied. Exposure to absolute maximum rating conditions for extended periods may affect device reliability.

ELECTRICAL CHARACTERISTICS

(VCC = +3.0V to +3.6V, CCL = 200nF coupling capacitor on each output, RL = 50Ω on each output, TA = 0°C to +70°C, unless otherwise noted. Typical values are at VCC = +3.3V and TA = +25°C.) (Note 3)

PARAMETER	SYMBOL	CONDITIONS	MIN	TYP	MAX	UNITS
DC PERFORMANCE						
Power-Supply Range	VCC		3.0		3.6	V
Supply Current	ICC	EN = VCC	OEQ2 = GND, OEQ1 = GND, OEQ0 = GND	205	260	mA
			OEQ2 = GND, OEQ1 = GND, OEQ0 = VCC	212	270	
			OEQ2 = GND, OEQ1 = VCC, OEQ0 = GND	214	270	
			OEQ2 = GND, OEQ1 = VCC, OEQ0 = VCC	247	305	
			OEQ2 = VCC, OEQ1 = GND, OEQ0 = GND	213	270	
			OEQ2 = VCC, OEQ1 = GND, OEQ0 = VCC	263	330	
			OEQ2 = VCC, OEQ1 = VCC, OEQ0 = GND	276	345	
			OEQ2 = VCC, OEQ1 = VCC, OEQ0 = VCC	328	410	

MAX14950

Quad PCI Express Equalizer/Redriver

ELECTRICAL CHARACTERISTICS (continued)

(V_{CC} = +3.0V to +3.6V, C_{CL} = 200nF coupling capacitor on each output, R_L = 50Ω on each output, T_A = 0°C to +70°C, unless otherwise noted. Typical values are at V_{CC} = +3.3V and T_A = +25°C.) (Note 3)

PARAMETER	SYMBOL	CONDITIONS	MIN	TYP	MAX	UNITS
Standby Current	I _{STBY}	EN = GND				mA
		OEQ2 = GND, OEQ1 = GND, OEQ0 = GND		113	150	
		OEQ2 = GND, OEQ1 = GND, OEQ0 = V _{CC}		122	150	
		OEQ2 = GND, OEQ1 = V _{CC} , OEQ0 = GND		125	155	
		OEQ2 = GND, OEQ1 = V _{CC} , OEQ0 = V _{CC}		150	185	
		OEQ2 = V _{CC} , OEQ1 = GND, OEQ0 = GND		122	150	
		OEQ2 = V _{CC} , OEQ1 = GND, OEQ0 = V _{CC}		172	210	
		OEQ2 = V _{CC} , OEQ1 = V _{CC} , OEQ0 = GND		184	225	
		OEQ2 = V _{CC} , OEQ1 = V _{CC} , OEQ0 = V _{CC}		237	290	
Differential Input Impedance	Z _{RX-DIFF-DC}	DC	80	100	120	Ω
Differential Output Impedance	Z _{TX-DIFF-DC}	DC	80	100	120	Ω
Common-Mode Resistance to GND When Input Terminations Are Not Powered	Z _{RX-HIGH-IMP-DC}	-150mV < V _{IN,CM} < 200mV	50			kΩ
Common-Mode Resistance to GND When Input Terminations Are Powered	Z _{RX-DC}	DC	20	25	30	Ω
Output Short-Circuit Current (Note 4)	I _{TX-SHORT}	Single-ended	90			mA
Common-Mode Delta Between Active and Idle States	V _{TX-CM-DC-ACTIVE-IDLE-DELTA}				8	mV
DC Output Offset During Active State	V _{TX-ACTIVE-DIFF-DC}	I(V _{OUT_P} - V _{OUT_N})			75	mV
DC Output Offset During Electrical Idle	V _{TX-IDLE-DIFF-DC}	I(V _{OUT_P} - V _{OUT_N})			75	mV

MAX14950

Quad PCI Express Equalizer/Redriver

ELECTRICAL CHARACTERISTICS (continued)

(V_{CC} = +3.0V to +3.6V, C_{CL} = 200nF coupling capacitor on each output, R_L = 50Ω on each output, T_A = 0°C to +70°C, unless otherwise noted. Typical values are at V_{CC} = +3.3V and T_A = +25°C.) (Note 3)

PARAMETER	SYMBOL	CONDITIONS	MIN	TYP	MAX	UNITS
AC PERFORMANCE (Note 4)						
Differential Input Return Loss	RLRX-DIFF	f = 0.05GHz to 1.25GHz	10			dB
		f = 1.25GHz to 2.5GHz	8			
		f = 2.5GHz to 4GHz	5			
Common-Mode Input Return Loss	RLRX-CM	f = 0.05GHz to 2.5GHz	6			dB
		f = 2.5GHz to 4GHz	4			
Differential Output Return Loss	RLTX-DIFF	f = 0.05GHz to 1.25GHz	10			dB
		f = 1.25GHz to 2.5GHz	8			
		f = 2.5GHz to 4GHz	4			
Common-Mode Output Return Loss	RLTX-CM	f = 0.05GHz to 2.5GHz	6			dB
		f = 2.5GHz to 4GHz	4			
Redriver Operation Differential Input-Signal Range	VRX-DIFF-PP		100		1200	mV _{P-P}
Full-Swing Differential Output Voltage (No Deemphasis)	VTX-DIFF-PP	I(V _{OUT_P} - V _{OUT_N}), OEQ2 = GND, OEQ1 = GND, OEQ0 = GND	800		1300	mV _{P-P}
Output Deemphasis Ratio, 0dB	VTX-DE-RATIO-0dB	OEQ2 = GND, OEQ1 = GND, OEQ0 = GND, Figure 1		0		dB
Output Deemphasis Ratio, 3.5dB	VTX-DE-RATIO-3.5dB	OEQ2 = GND, OEQ1 = GND, OEQ0 = V _{CC} , Figure 1		3.5		dB
Output Deemphasis Ratio, 6dB	VTX-DE-RATIO-6dB	OEQ2 = GND, OEQ1 = V _{CC} , OEQ0 = GND, Figure 1		6		dB
Output Deemphasis Ratio, 6dB with Higher Amplitude	VTX-DE-HA-RATIO-6dB	OEQ2 = GND, OEQ1 = V _{CC} , OEQ0 = V _{CC} , Figure 1		6		dB
Output Deemphasis Ratio, 3.5dB with Preshoot	VTX-DE-PS-RATIO-3.5dB	OEQ2 = V _{CC} , OEQ1 = GND, OEQ0 = GND, Figure 1		3.5		dB
Output Deemphasis Ratio, 6dB with Preshoot	VTX-DE-PS-RATIO-6dB	OEQ2 = V _{CC} , OEQ1 = GND, OEQ0 = V _{CC} , Figure 1		6		dB
Output Deemphasis Ratio, 9dB with Preshoot	VTX-DE-PS-RATIO-9dB	OEQ2 = V _{CC} , OEQ1 = V _{CC} , OEQ0 = GND, Figure 1		9		dB
Output Deemphasis Ratio, 9dB with Preshoot with Higher Amplitude	VTX-DE-PS-HA-RATIO-9dB	OEQ2 = V _{CC} , OEQ1 = V _{CC} , OEQ0 = V _{CC} , Figure 1		9		dB
Input Equalization, 5dB	VRX-EQ-5dB	INEQ1 = GND, INEQ0 = GND (Note 5)		5		dB
Input Equalization, 8dB	VRX-EQ-8dB	INEQ1 = GND, INEQ0 = V _{CC} (Note 5)		8		dB
Input Equalization, 12dB	VRX-EQ-12dB	INEQ1 = V _{CC} , INEQ0 = GND (Note 5)		12		dB

MAX14950

Quad PCI Express Equalizer/Redriver

ELECTRICAL CHARACTERISTICS (continued)

(V_{CC} = +3.0V to +3.6V, C_{CL} = 200nF coupling capacitor on each output, R_L = 50Ω on each output, T_A = 0°C to +70°C, unless otherwise noted. Typical values are at V_{CC} = +3.3V and T_A = +25°C.) (Note 3)

PARAMETER	SYMBOL	CONDITIONS	MIN	TYP	MAX	UNITS
Input Equalization, 16dB	V _{RX-EQ-16dB}	INEQ1 = V _{CC} , INEQ0 = V _{CC} (Note 5)		16		dB
AC PERFORMANCE (Note 4)						
Output Common-Mode Voltage Swing Peak-to-Peak	V _{TX-CM-AC-PP}	Max(V _{OUT_P} + V _{OUT_N})/2 - Min(V _{OUT_P} + V _{OUT_N})/2			100	mV _{P-P}
Propagation Delay	t _{PD}		120	160	240	ps
Rise/Fall Time	t _{TX-RISE-FALL}	(Note 6)	20			ps
Rise/Fall Time Mismatch	t _{TX-RF-MISMATCH}	(Note 6)			5	ps
Deterministic Jitter	t _{TX-DJ-DD}	K28.5 pattern, AC-coupled, R _L = 50Ω, data rate = 8GT/s		10.5	23.5	ps _{P-P}
Random Jitter	t _{TX-RJ-DD}	D10.2 pattern, no deemphasis, no preshoot, data rate = 8GT/s		0.5	1.5	ps _{RMS}
Electrical Idle Entry Delay	t _{TX-IDLE-SET-TO-IDLE}	From input to output, D10.2 pattern, data rate = 1GT/s		5	8	ns
Electrical Idle Exit Delay	t _{TX-IDLE-TO-DIFF-DATA}	From input to output, D10.2 pattern, data rate = 1GT/s		5	8	ns
Electrical Idle Detect Threshold	V _{TX-IDLE-THRESH}	D10.2 pattern, data rate = 1GT/s (Note 3)	65	112	175	mV _{P-P}
		D10.2 pattern, data rate = 1GT/s to 8GT/s		112		
Output Voltage During Electrical Idle (AC)	V _{TX-IDLE-DIFF-AC-P}	V _{OUT_P} - V _{OUT_N}			20	mV _{P-P}
Receiver Detection Pulse Amplitude	V _{TX-RCV-DETECT}	Voltage change in positive direction		600		mV
Receiver Detection Pulse Width				150		ns
Receiver Detection Retry Period				300		ns
CONTROL LOGIC						
Input Logic-Level Low	V _{IL}				0.6	V
Input Logic-Level High	V _{IH}		1.4			V
Input Logic Hysteresis	V _{HYST}			0.1		V
Input Pulldown Resistance	R _{PD}		200	250		kΩ
ESD PROTECTION						
ESD Voltage		Human Body Model		±5		kV

Note 3: All units are 100% production tested at T_A = +70°C. Specifications for all temperature limits are guaranteed by design.

Note 4: Guaranteed by design, unless otherwise noted.

Note 5: Equivalent to same amount of deemphasis driving the input.

Note 6: Rise and fall times are measured using 20% and 80% levels.

MAX14950

Quad PCI Express Equalizer/Redriver

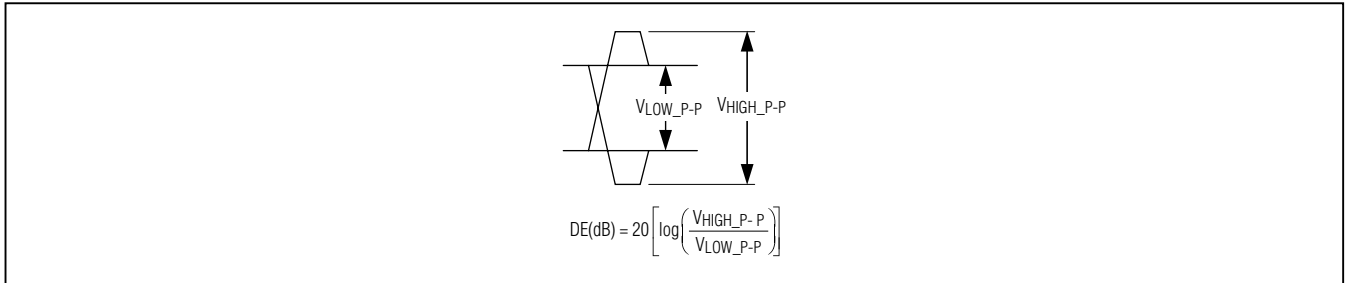
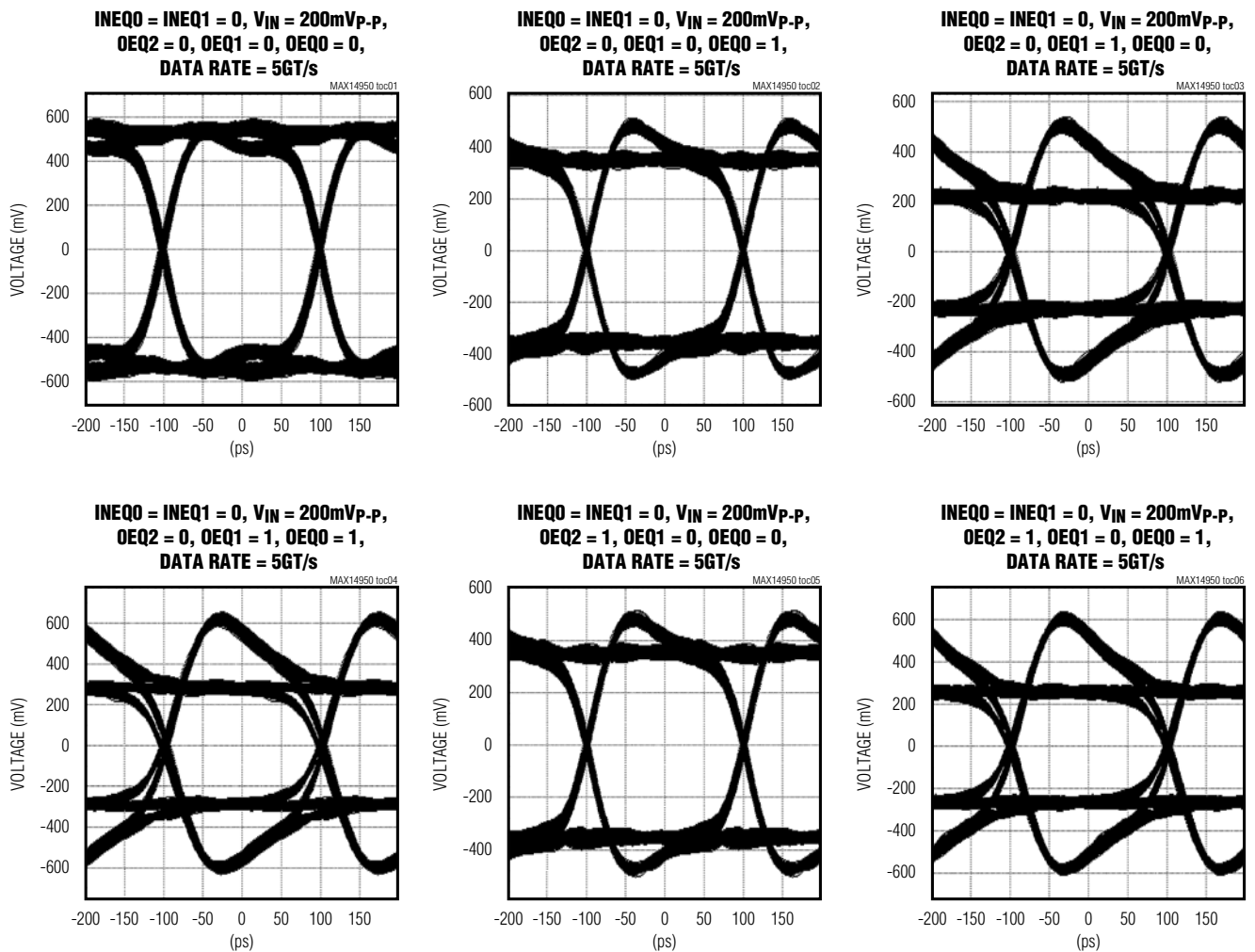

Figure 1. Illustration of Output Deemphasis

Typical Operating Characteristics

($T_A = +25^\circ\text{C}$, unless otherwise noted.)



Quad PCI Express Equalizer/Redriver

Typical Operating Characteristics (continued)

(T_A = +25°C, unless otherwise noted.)

**INEQ0 = INEQ1 = 0, V_{IN} = 200mVp-p,
OEQ2 = 1, OEQ1 = 0, OEQ0 = 1,
DATA RATE = 5GT/s**

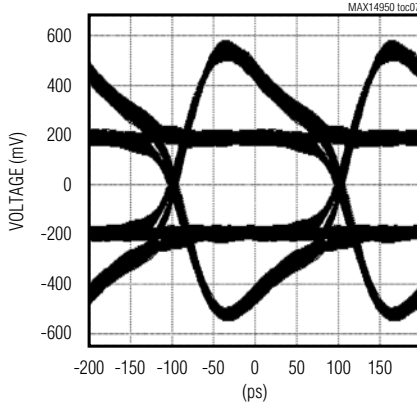

**INEQ0 = INEQ1 = 0, V_{IN} = 200mVp-p,
OEQ2 = 1, OEQ1 = 1, OEQ0 = 1,
DATA RATE = 5GT/s**

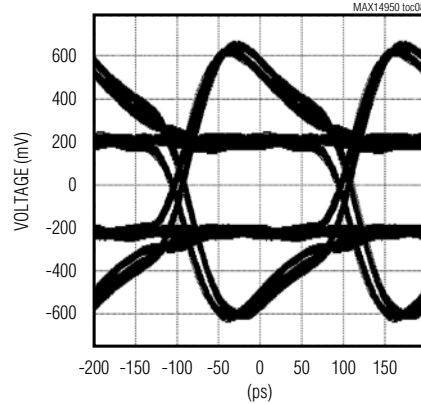

**INEQ1 = 0, INEQ0 = 1, V_{IN} = 500mVp-p,
OEQ2 = OEQ1 = OEQ0 = 0, 6in MICROSTRIP
ON INPUT, DATA RATE = 5GT/s**

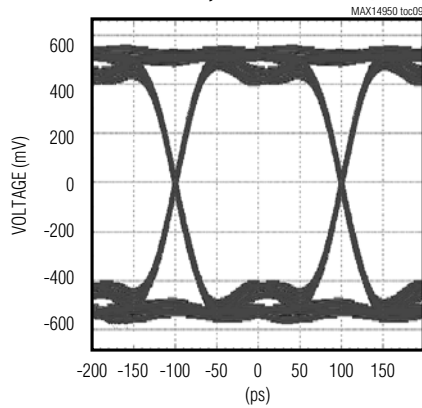

**INEQ1 = 0, INEQ0 = 1, V_{IN} = 500mVp-p,
OEQ2 = OEQ1 = OEQ0 = 0, 12in MICROSTRIP
ON INPUT, DATA RATE = 5GT/s**

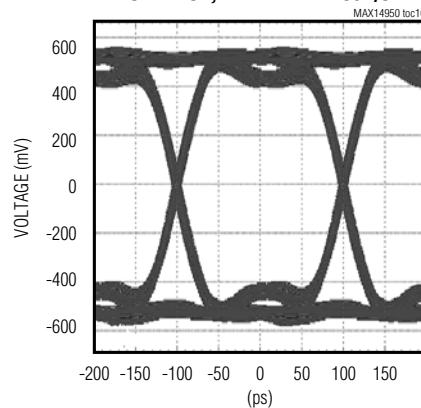

**INEQ1 = 1, INEQ0 = 0, V_{IN} = 500mVp-p,
OEQ2 = OEQ1 = OEQ0 = 0, 18in MICROSTRIP
ON INPUT, DATA RATE = 5GT/s**

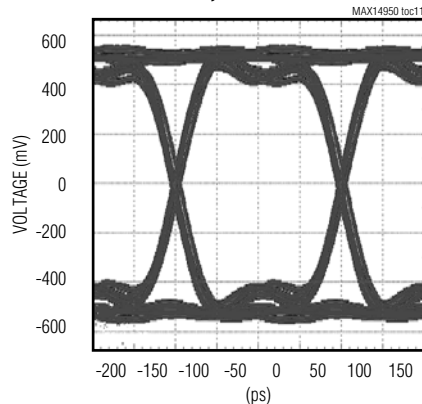

**INEQ1 = 1, INEQ0 = 1, V_{IN} = 500mVp-p,
OEQ2 = OEQ1 = OEQ0 = 0, 24in MICROSTRIP
ON INPUT, DATA RATE = 5GT/s**

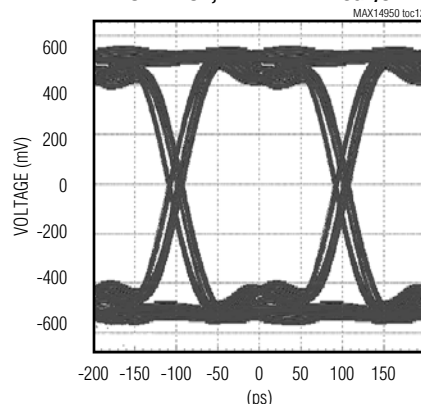

MAX14950

Quad PCI Express Equalizer/Redriver

Typical Operating Characteristics (continued)

($T_A = +25^\circ\text{C}$, unless otherwise noted.)

**INEQ0 = INEQ1 = 0, $V_{IN} = 200\text{mVp-p}$,
OEQ2 = 0, OEQ1 = 0, OEQ0 = 1,
OUTPUT AFTER 19in STRIPLINE, DATA RATE = 5GT/s**

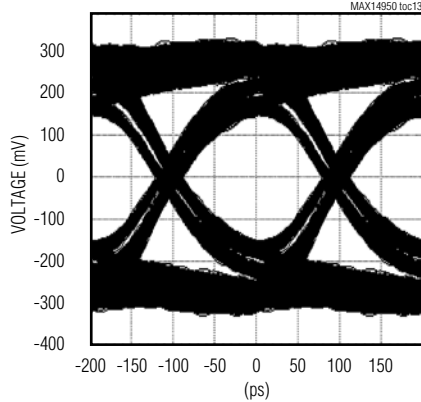

**INEQ0 = INEQ1 = 0, $V_{IN} = 200\text{mVp-p}$,
OEQ2 = 1, OEQ1 = 1, OEQ0 = 1,
OUTPUT AFTER 19in STRIPLINE, DATA RATE = 5GT/s**

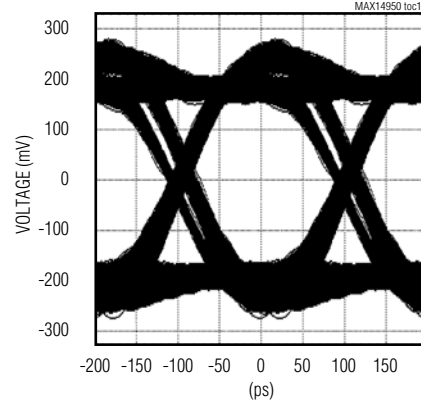

**INEQ0 = INEQ1 = 0, $V_{IN} = 200\text{mVp-p}$,
OEQ2 = 1, OEQ1 = 1, OEQ0 = 0,
OUTPUT AFTER 19in STRIPLINE, DATA RATE = 5GT/s**

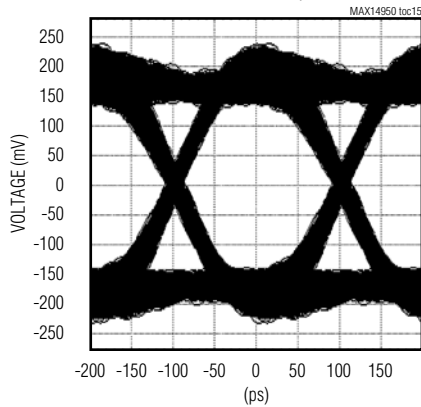

**INEQ0 = INEQ1 = 0, $V_{IN} = 200\text{mVp-p}$,
OEQ2 = 1, OEQ1 = 0, OEQ0 = 1,
OUTPUT AFTER 19in STRIPLINE, DATA RATE = 5GT/s**

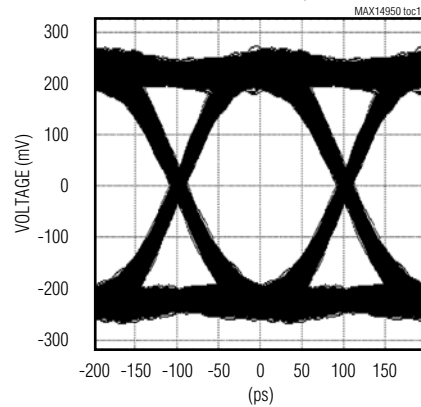

**INEQ0 = INEQ1 = 0, $V_{IN} = 200\text{mVp-p}$,
OEQ2 = 0, OEQ1 = 1, OEQ0 = 1,
OUTPUT AFTER 19in STRIPLINE, DATA RATE = 5GT/s**

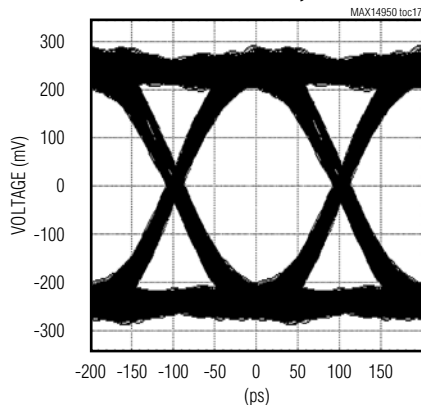

**INEQ0 = INEQ1 = 0, $V_{IN} = 200\text{mVp-p}$,
OEQ2 = 1, OEQ1 = 0, OEQ0 = 1,
OUTPUT AFTER 19in STRIPLINE, DATA RATE = 5GT/s**

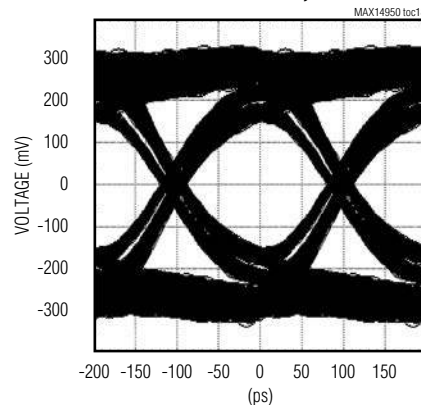

Quad PCI Express Equalizer/Redriver

Typical Operating Characteristics (continued)

(T_A = +25°C, unless otherwise noted.)

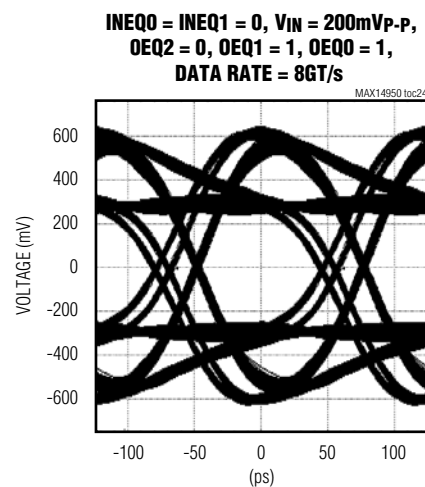
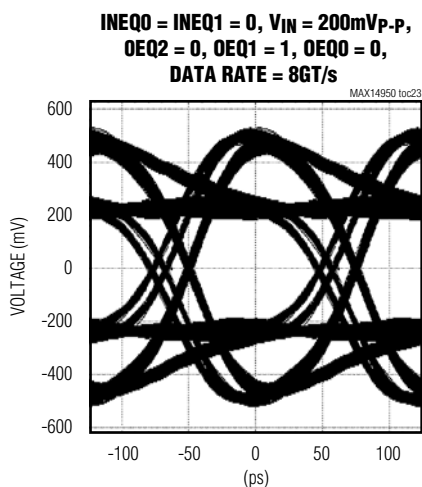
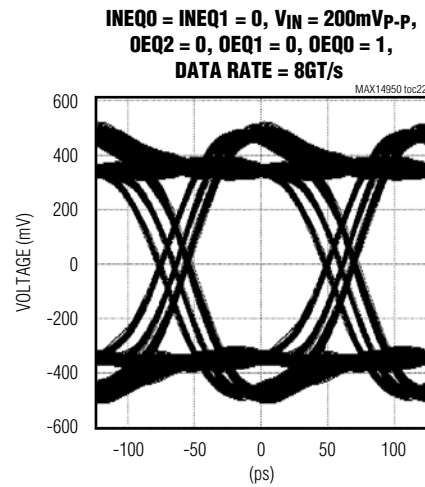
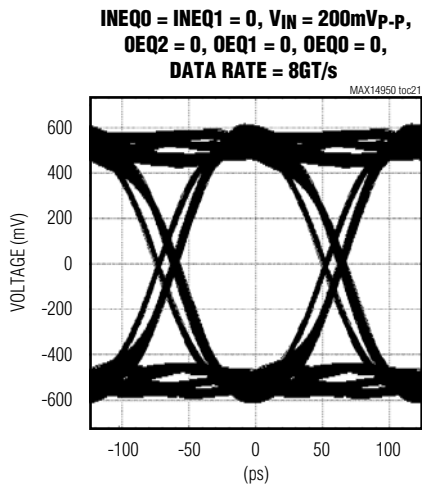
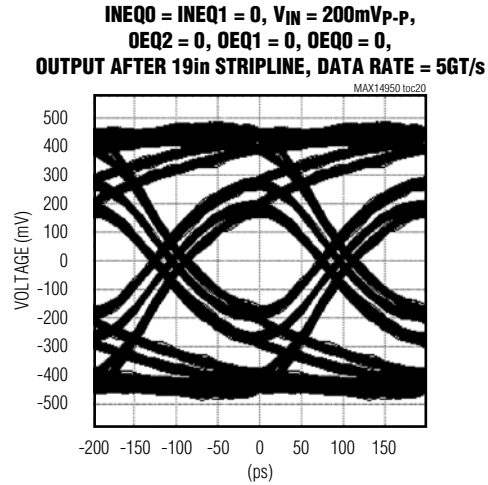
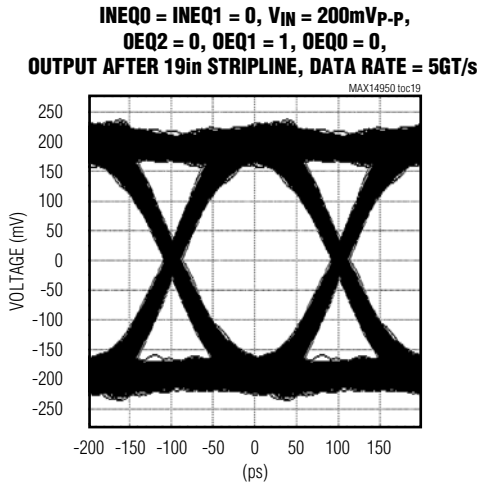

MAX14950

Quad PCI Express Equalizer/Redriver

Typical Operating Characteristics (continued)

($T_A = +25^\circ\text{C}$, unless otherwise noted.)

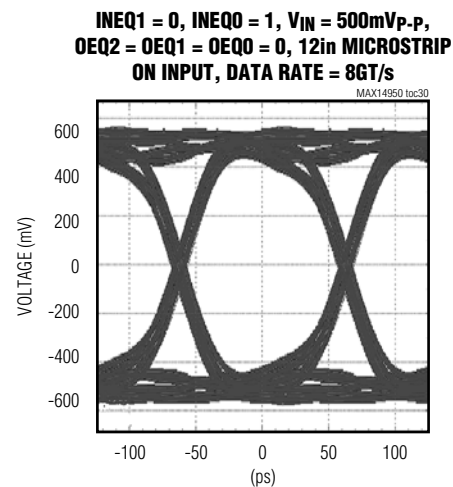
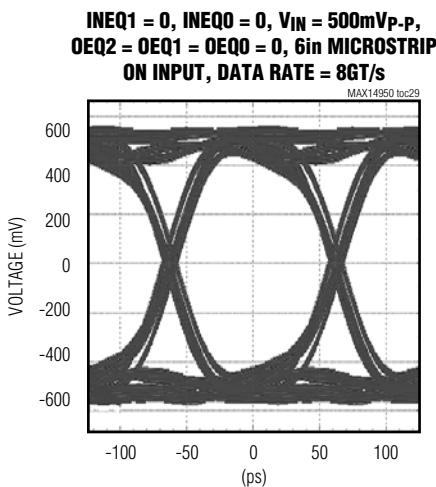
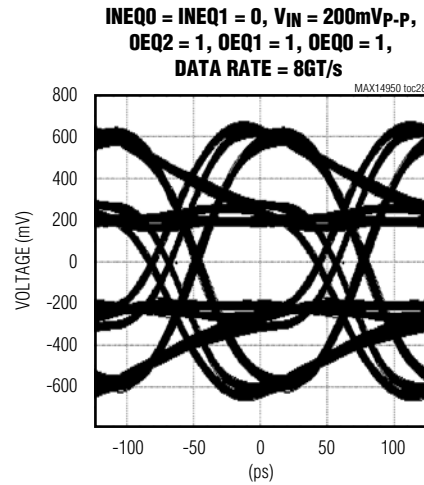
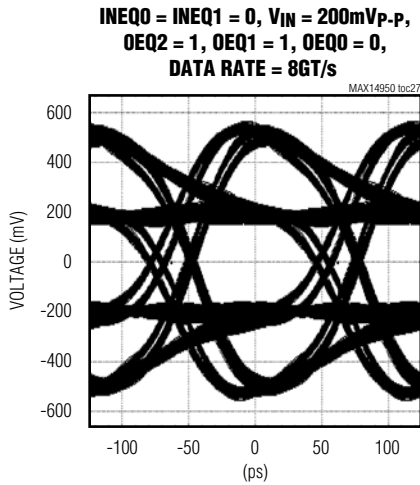
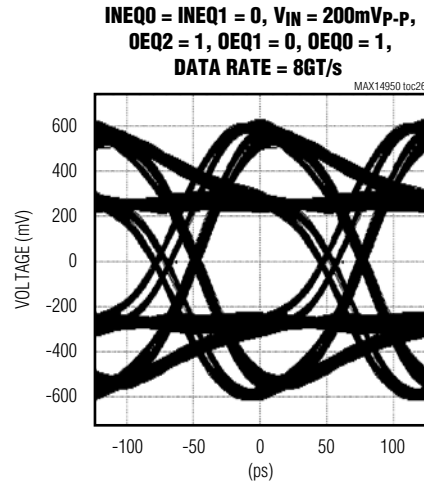
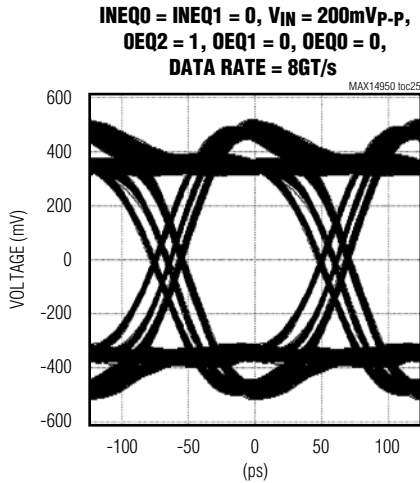

MAX14950

Quad PCI Express Equalizer/Redriver

Typical Operating Characteristics (continued)

($T_A = +25^\circ\text{C}$, unless otherwise noted.)

**INEQ1 = 1, INEQ0 = 0, $V_{IN} = 500\text{mVp-p}$,
OEQ2 = OEQ1 = OEQ0 = 0, 18in MICROSTRIP
ON INPUT, DATA RATE = 8GT/s**

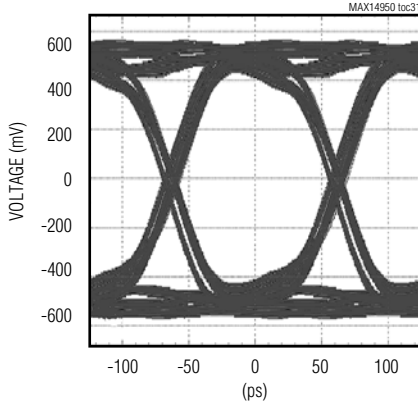

**INEQ1 = 1, INEQ0 = 1, $V_{IN} = 500\text{mVp-p}$,
OEQ2 = OEQ1 = OEQ0 = 0, 24in MICROSTRIP
ON INPUT, DATA RATE = 8GT/s**

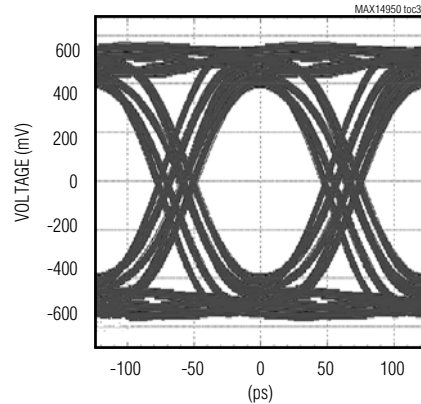

**INEQ0 = INEQ1 = 0, $V_{IN} = 200\text{mVp-p}$,
OEQ2 = 0, OEQ1 = 0, OEQ0 = 1,
OUTPUT AFTER 19in STRIPLINE, DATA RATE = 8GT/s**

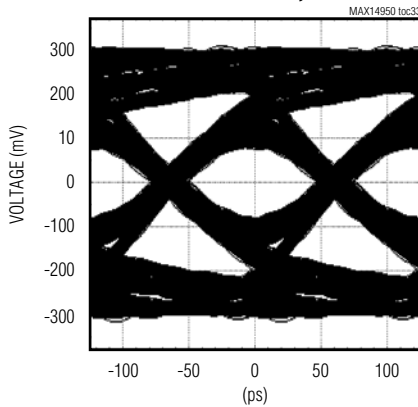

**INEQ0 = INEQ1 = 0, $V_{IN} = 200\text{mVp-p}$,
OEQ2 = 1, OEQ1 = 1, OEQ0 = 1,
OUTPUT AFTER 19in STRIPLINE, DATA RATE = 8GT/s**

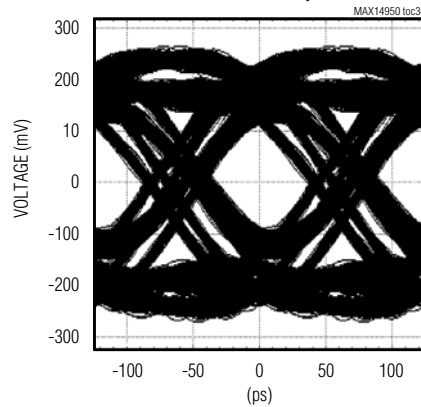

**INEQ0 = INEQ1 = 0, $V_{IN} = 200\text{mVp-p}$,
OEQ2 = 1, OEQ1 = 1, OEQ0 = 0,
OUTPUT AFTER 19in STRIPLINE, DATA RATE = 8GT/s**

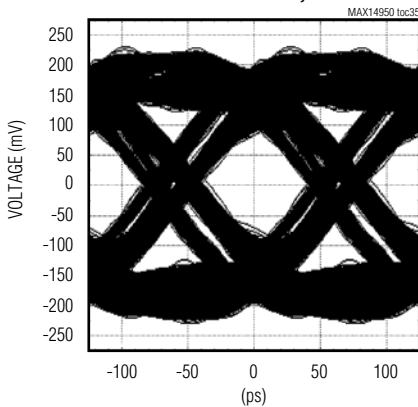

**INEQ0 = INEQ1 = 0, $V_{IN} = 200\text{mVp-p}$,
OEQ2 = 1, OEQ1 = 0, OEQ0 = 1,
OUTPUT AFTER 19in STRIPLINE, DATA RATE = 8GT/s**

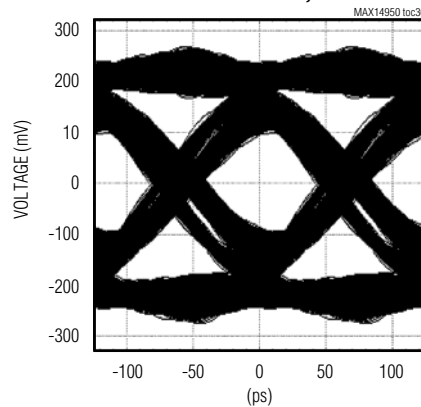

MAX14950

Quad PCI Express Equalizer/Redriver

Typical Operating Characteristics (continued)

($T_A = +25^\circ\text{C}$, unless otherwise noted.)

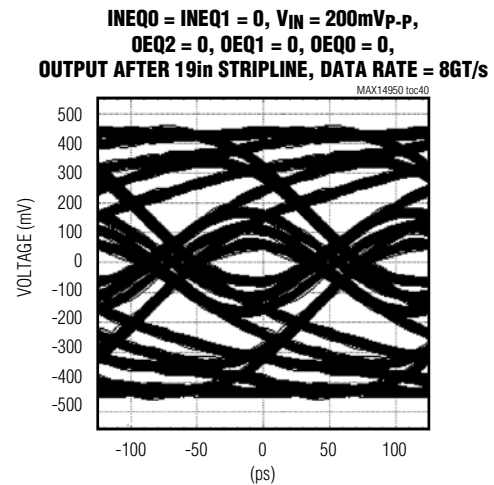
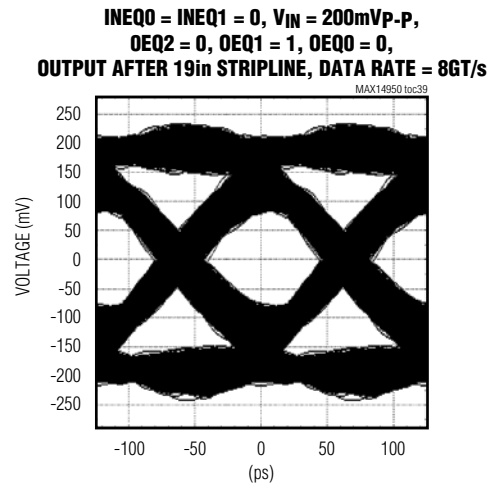
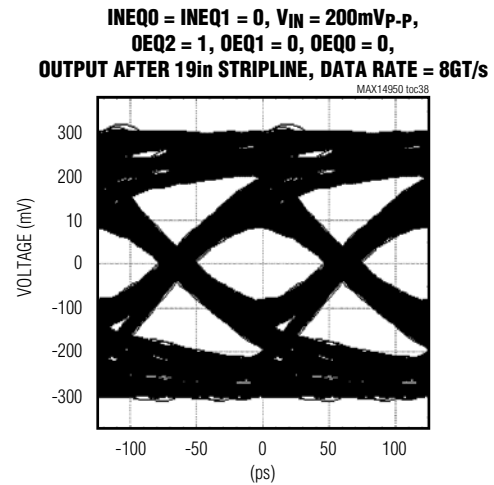
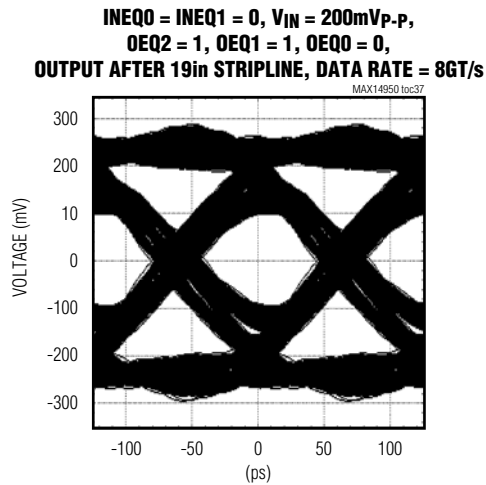

MAX14950

Quad PCI Express Equalizer/Redriver

Pin Configuration

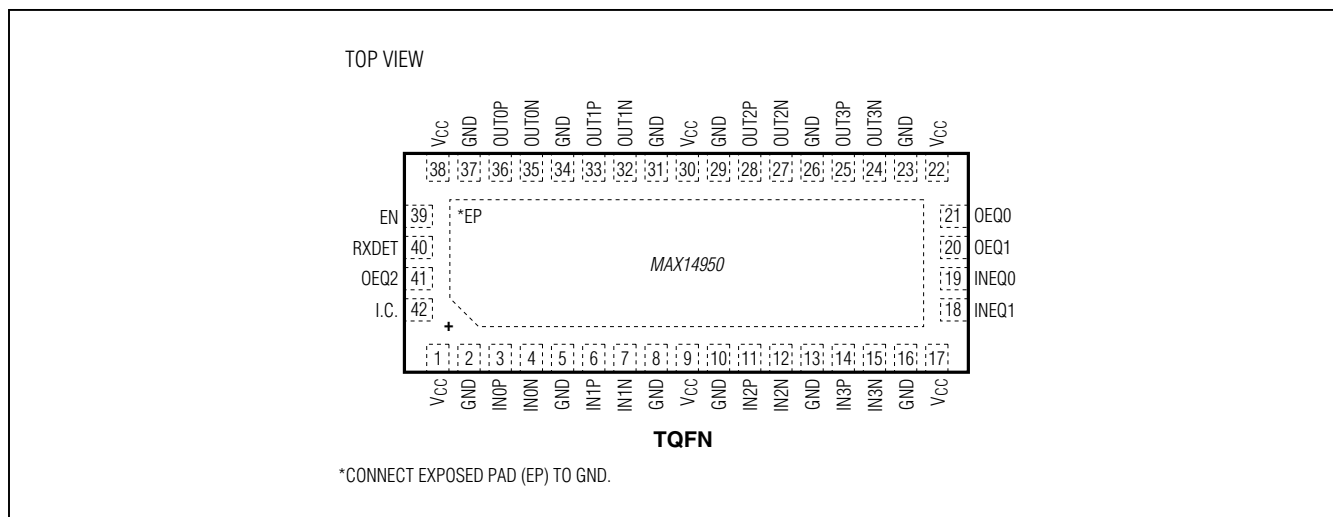

Pin Description

PIN	NAME	FUNCTION
1, 9, 17, 22, 30, 38	VCC	Power-Supply Input. Bypass VCC to GND with 1 μ F and 0.1 μ F capacitors in parallel as close as possible to the device.
2, 5, 8, 10, 13, 16, 23, 26, 29, 31, 34, 37	GND	Ground
3	IN0P	Noninverting Input, Channel 0
4	IN0N	Inverting Input, Channel 0
6	IN1P	Noninverting Input, Channel 1
7	IN1N	Inverting Input, Channel 1
11	IN2P	Noninverting Input, Channel 2
12	IN2N	Inverting Input, Channel 2
14	IN3P	Noninverting Input, Channel 3
15	IN3N	Inverting Input, Channel 3
18	INEQ1	Input Equalization Control MSB. INEQ1 has a 250k Ω (typ) internal pulldown resistor.
19	INEQ0	Input Equalization Control LSB. INEQ0 has a 250k Ω (typ) internal pulldown resistor.
20	OEQ1	Output Deemphasis Control Bit 1. OEQ1 has a 250k Ω (typ) internal pulldown resistor.
21	OEQ0	Output Deemphasis Control LSB. OEQ0 has a 250k Ω (typ) internal pulldown resistor.
24	OUT3N	Inverting Output, Channel 3
25	OUT3P	Noninverting Output, Channel 3
27	OUT2N	Inverting Output, Channel 2
28	OUT2P	Noninverting Output, Channel 2
32	OUT1N	Inverting Output, Channel 1
33	OUT1P	Noninverting Output, Channel 1

MAX14950

Quad PCI Express Equalizer/Redriver

Pin Description (continued)

PIN	NAME	FUNCTION
35	OUT0N	Inverting Output, Channel 0
36	OUT0P	Noninverting Output, Channel 0
39	EN	Enable Input. Drive EN low for standby mode. Drive EN high for normal mode. EN has a 250kΩ (typ) internal pulldown resistor.
40	RXDET	Receiver Detection Control Bit. Drive RXDET high to initiate receiver detection. Drive RXDET low for normal mode. RXDET has a 250kΩ (typ) internal pulldown resistor.
41	OEQ2	Output Deemphasis Control MSB. OEQ2 has a 250kΩ (typ) internal pulldown resistor.
42	I.C.	Internally Connected
—	EP	Exposed Pad. Internally connected to GND. Connect EP to a large ground plane to maximize thermal performance as well as good ground conductivity to the device.

Functional Diagram

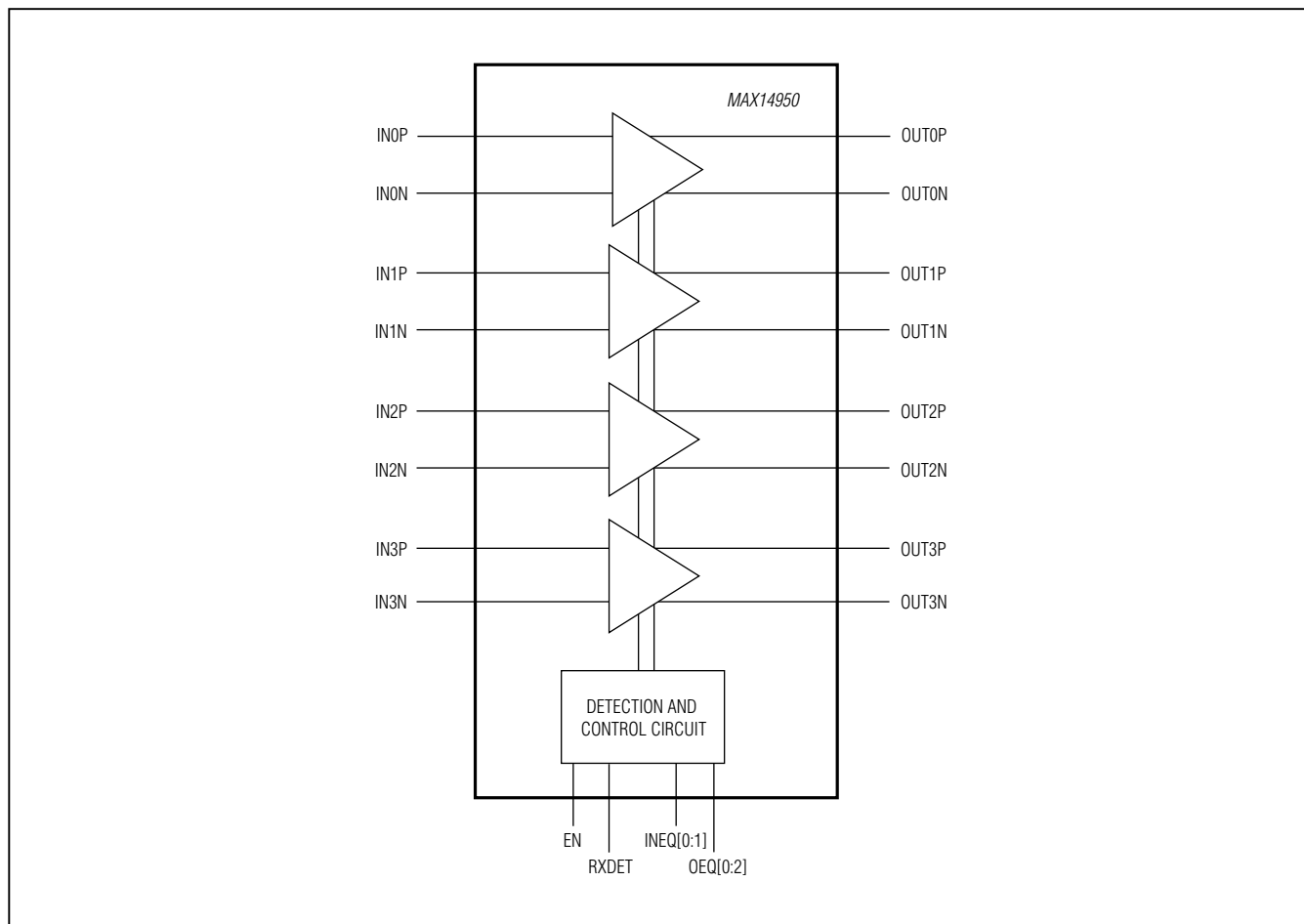

Quad PCI Express Equalizer/Redriver

Detailed Description

The MAX14950 quad equalizer/redriver is designed to support Gen III (8.0GT/s), Gen II (5.0GT/s), and Gen I (2.5GT/s) PCIe data rates. The device contains four identical drivers with electrical idle/receive detect on each lane and equalization/deemphasis/preshoot to compensate for circuit-board loss. Programmable input equalization circuitry reduces deterministic jitter, improving signal integrity. The device output features a programmable output deemphasis/preshoot, permitting optimal placement of key PCIe components and longer runs of stripline, microstrip, or cable.

Programmable Input Equalization

Programmable input equalization is controlled by two bits: INEQ1 and INEQ0 (Table 1).

Table 1. Input Equalization

INEQ1	INEQ0	INPUT EQUALIZATION (dB)
0	0	5
0	1	8
1	0	12
1	1	16

Programmable Output Deemphasis/Preshoot

Programmable output deemphasis is controlled by three bits: OEQ2, OEQ1, and OEQ0 for deemphasis/preshoot ratios of 0dB, 3.5dB, 6dB, and 9dB (Table 2).

Table 2. Output Deemphasis/Preshoot

OEQ2	OEQ1	OEQ0	OUTPUT DEEMPHASIS/PRESHOOT RATIO (dB)
0	0	0	0
0	0	1	3.5
0	1	0	6
0	1	1	6 (Peak-to-Peak Swing is 1.2V)
1	0	0	3.5
1	0	1	6
1	1	0	9 (Peak-to-Peak Swing is 0.9V)
1	1	1	9 (Peak-to-Peak Swing is 1.0V)

Receiver Detection

The device features receiver detection on each channel. Upon initial power-up, if EN is high, receiver detection initializes. Receiver detection can also be initiated on a rising or falling edge of the RXDET input when EN is high. During this time, the device remains in low-power standby mode and the outputs are disabled, despite the logic-high state of EN. Until a channel has detected a receiver, the receiver detection repeats indefinitely on each channel. If a channel detects a receiver, the other channels are limited to retries for 100ms (typ). For each channel upon receiver detection, input common-mode termination and electrical idle detection are enabled (Table 3).

Electrical Idle Detection

The device features electrical idle detection to prevent unwanted noise from being redriven at the output. When the device detects that the differential input has fallen below the VTX-IDLE-THRESH low limit, it squelches the output. For differential input signals that are above VTX-IDLE-THRESH high limit, the device turns on the output and redrives the signal. There is little variation in output common-mode voltage between electrical idle and redrive modes.

Table 3. Receiver Detection Input Function

RXDET	EN	DESCRIPTION
X	0	Receiver detection is inactive.
X	1	Following a rising edge of EN signal, indefinite retry until receiver detects at least one channel. Retries stop after 100ms (typ) if any channel receiver is detected.
Rising/Falling Edge	1	Initiates receiver detection.

X = Don't care.

MAX14950

Quad PCI Express Equalizer/Redriver

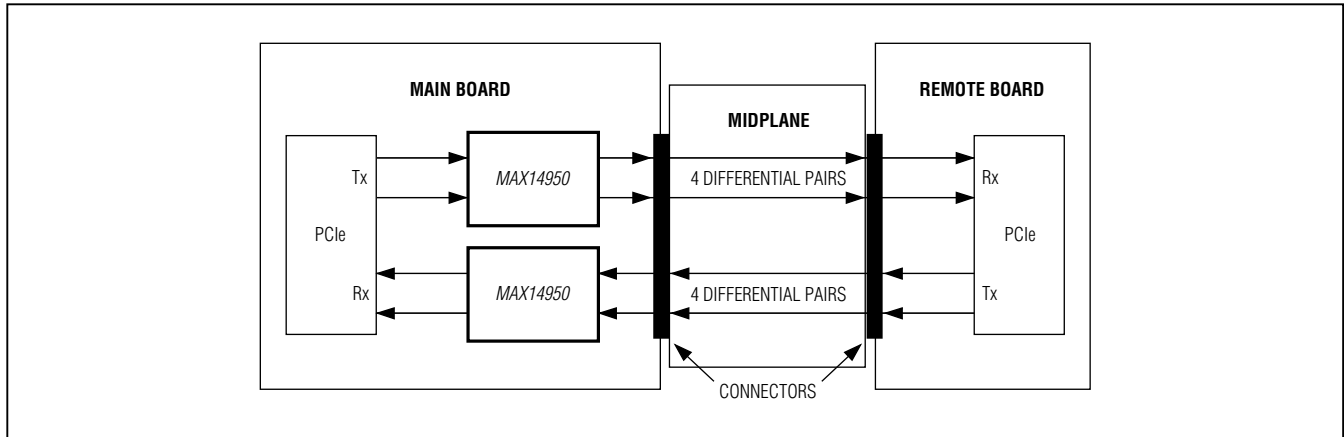

Figure 2. Typical Application Diagram

Applications Information

Figure 2 shows a typical application with two MAX14950s, both residing on the main board, with input and output equalization set individually for optimal performance. The MAX14950 Rx equalizer is set to receive a degraded signal coming from a remote board through two sets of connectors and a midplane stripline. The output of the Rx section has little or no output equalization. The Tx section takes a high-quality signal and provides boost to the output (deemphasis).

Layout

Circuit-board layout and design can significantly affect the performance of the device. Use good, high-frequency design techniques, including minimizing ground inductance and using controlled-impedance transmission lines on data signals. Power-supply decoupling should also be placed as close as possible to VCC. Always connect VCC to a power plane. It is recommended to run receive and transmit signals on different layers to minimize crosstalk.

Exposed-Pad Package

The exposed-pad, 42-pin TQFN package incorporates features that provide a very low-thermal-resistance path for heat removal from the IC. The exposed pad on the device must be soldered to the circuit-board ground

plane for proper thermal performance and good ground connectivity. For more information on exposed-pad packages, refer to Application Note 862: *HFAN-08.1: Thermal Considerations of QFN and Other Exposed-Paddle Packages*.

Power-Supply Sequencing

Caution: Do not exceed the absolute maximum ratings because stresses beyond the listed ratings may cause permanent damage to the device.

Proper power-supply sequencing is recommended for all devices. Always apply GND then VCC before applying signals, especially if the signal is not current limited.

Chip Information

PROCESS: BiCMOS

Package Information

For the latest package outline information and land patterns (footprints), go to www.maximintegrated.com/packages. Note that a "+", "#", or "-" in the package code indicates RoHS status only. Package drawings may show a different suffix character, but the drawing pertains to the package regardless of RoHS status.

PACKAGE TYPE	PACKAGE CODE	OUTLINE NO.	LAND PATTERN NO.
42 TQFN-EP	T423590+1	21-0181	90-0078

MAX14950

Quad PCI Express Equalizer/Redriver

Revision History

REVISION NUMBER	REVISION DATE	DESCRIPTION	PAGES CHANGED
0	12/10	Initial release	—
1	11/12	Removed military application information; updated <i>Electrical Characteristics</i> table, <i>Typical Operating Characteristics</i> , <i>Pin Configuration</i> , and <i>Pin Description</i> .	1, 3–16



Maxim Integrated cannot assume responsibility for use of any circuitry other than circuitry entirely embodied in a Maxim Integrated product. No circuit patent licenses are implied. Maxim Integrated reserves the right to change the circuitry and specifications without notice at any time. The parametric values (min and max limits) shown in the Electrical Characteristics table are guaranteed. Other parametric values quoted in this data sheet are provided for guidance.

Maxim Integrated 160 Rio Robles, San Jose, CA 95134 USA 1-408-601-1000

17