

Description

The DIODES™ AL3159 is a low noise, constant frequency charge pump DC/DC converter that uses a dual mode load switch (1x), and (2x) conversion for white LED applications. The AL3159 is capable of driving nine LED channels at 20mA from a 2.7V to 5.5V input. The current sinks may be operated using three simple logic control inputs individually or in parallel for driving higher-current LEDs. Low external part counts (one 1μF flying capacitor and two 2.2μF capacitors at V_{IN} and V_{OUT}) make this part ideally suited for small, battery-powered applications.

AL3159 digital inputs are used to enable or disable the LED channels with a fixed default current settings at 20mA or other factory programming options available.

Each output of the AL3159 is equipped with built-in protection for V_{OUT} short circuit and auto-disable for LED short conditions. Built-in soft-start circuitry prevents excessive inrush current during start-up and mode switching. A low-current shutdown feature disconnects the load from V_{IN} to reduce quiescent current less than 1μA.

The AL3159 is available in a lead-free, space-saving, thermally enhanced 20-pin 3 x 3mm QFN3030-20 package.

Features

- V_{IN} Range: 2.7V to 5.5V
- Up to 93% Max Power Efficiency
- 1% Current Matching Accuracy Between Channels
- Drives up to 9 Configurable Channels of LEDs
- Three Simple Logic Decoding LED On/Off Control Inputs
- Low Transition Threshold Voltage Typical 150mV
- Dual-Mode 1x and 2x Charge Pump
- 1.2MHz Constant Switching Frequency
- V_{OUT} Short Circuit and Thermal Protections
- Soft Start for Reducing Inrush Current
- $I_Q < 1\mu A$ in Shutdown
- Thermally-Enhanced QFN3030-20 Package: Available in "Green" Molding Compound (No Br, Sb)
- **Totally Lead-Free & Fully RoHS Compliant (Notes 1 & 2)**
- **Halogen and Antimony Free. "Green" Device (Note 3)**
- **For automotive applications requiring specific change control (i.e. parts qualified to AEC-Q100/101/104/200, PPAP capable, and manufactured in IATF 16949 certified facilities), please [contact us](#) or your local Diodes representative. <https://www.diodes.com/quality/product-definitions/>**

Notes: 1. No purposely added lead. Fully EU Directive 2002/95/EC (RoHS), 2011/65/EU (RoHS 2) & 2015/863/EU (RoHS 3) compliant.
2. See <https://www.diodes.com/quality/lead-free/> for more information about Diodes Incorporated's definitions of Halogen- and Antimony-free, "Green" and Lead-free.
3. Halogen- and Antimony-free "Green" products are defined as those which contain <900ppm bromine, <900ppm chlorine (<1500ppm total Br + Cl) and <1000ppm antimony compounds.

Pin Assignments

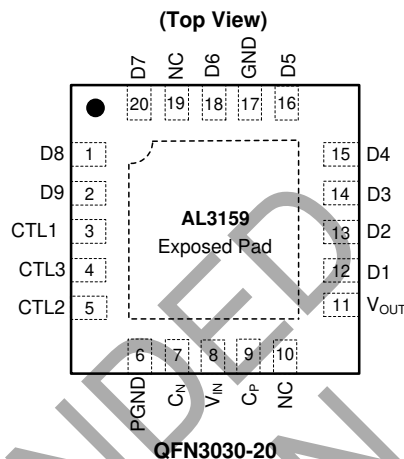

Applications

- Mobile phone white LED backlighting and indicators
- PDA white LED backlighting
- Battery-operated phone main and sub screen white LED backlighting

Typical Application Circuit

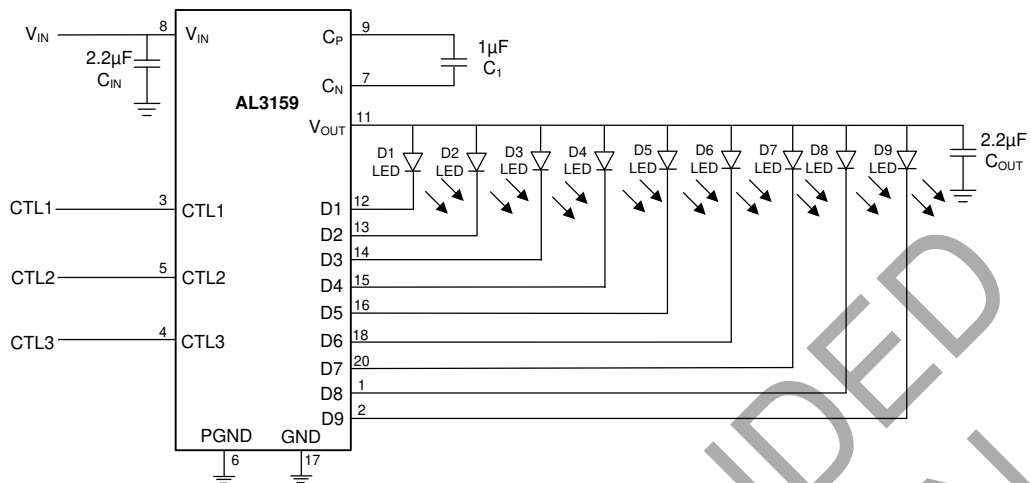

Pin Descriptions

Pin Name	Pin Number	Description
D8	1	Current Sink Input #8. Connected to V_{OUT} when unused.
D9	2	Current Sink Input #9. Connected to V_{OUT} when unused.
CTL1	3	Control Pin 1
CTL3	4	Control Pin 3
CTL2	5	Control Pin 2
PGND	6	Charge Pump Switch Ground
CN	7	Negative Terminal of Flying Capacitor
VIN	8	Input Power Supply. Requires 2.2µF capacitor between this pin and ground.
CP	9	Positive Terminal of Flying Capacitor
NC	10, 19	No-Connect
VOUT	11	Charge Pump Output to Drive Load Circuit. Requires 2.2µF capacitor between this pin and ground.
D1	12	Current Sink Input #1. Connected to V_{OUT} when unused.
D2	13	Current Sink Input #2. Connected to V_{OUT} when unused.
D3	14	Current Sink Input #3. Connected to V_{OUT} when unused.
D4	15	Current Sink Input #4. Connected to V_{OUT} when unused.
D5	16	Current Sink Input #5. Connected to V_{OUT} when unused.
GND	17	Ground
D6	18	Current Sink Input #6. Connected to V_{OUT} when unused.
D7	20	Current Sink Input #7. Connected to V_{OUT} when unused.
Exposed Pad	EP Pad	Exposed Pad (bottom). Connected to GND directly underneath the package.

Functional Block Diagram

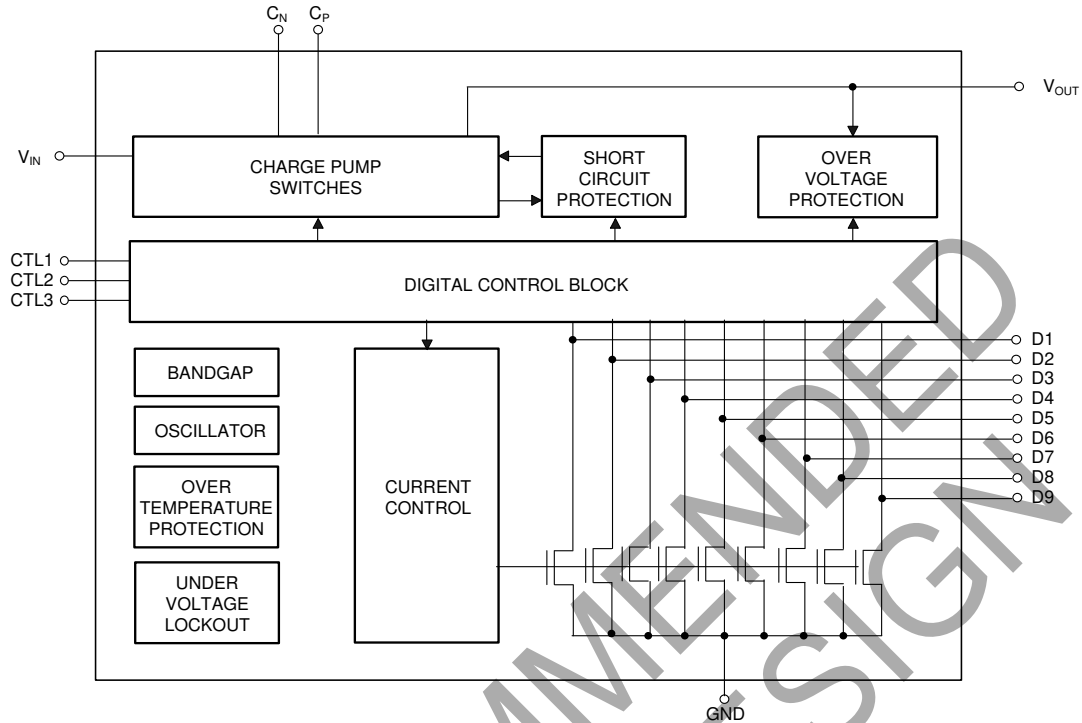

Absolute Maximum Ratings (Note 4)

Symbol	Description	Rating	Unit
ESD HBM	Human Body Model ESD Protection	2	kV
ESD MM	Machine Model ESD Protection	200	V
V _{IN}	Input Voltage	-0.3 to 6	V
V _{CTL1, 2, 3}	CTL1, CTL2, CTL3 to GND Voltage	-0.3 to V _{IN} +0.3	V
I _{OUT}	Maximum DC Output Current	270	mA
T _J	Operating Junction Temperature	+150	°C
T _{LEAD}	Maximum Soldering Temperature (at leads, 10 sec)	+300	°C

Note: 4. Stresses greater than those listed under *Absolute Maximum Ratings* can cause permanent damage to the device. These are stress ratings only, and functional operation of the device at these or any other conditions beyond those indicated under *Recommended Operating Conditions* is not implied. Exposure to *Absolute Maximum Ratings* for extended periods can affect device reliability.

Recommended Operating Conditions

Symbol	Parameter	Min	Max	Unit
V _{IN}	Input Voltage	2.7	5.5	V
T _A	Operating Ambient Temperature	-40	+85	°C

Electrical Characteristics ($T_A = +25^\circ\text{C}$, $V_{IN} = 3.6\text{V}$, $C_{IN} = C_{OUT} = 2.2\mu\text{F}$, $C_1 = 1\mu\text{F}$, unless otherwise noted)

Symbol	Parameter	Test Conditions	Min	Typ.	Max	Unit
I _Q	Quiescent Current	1x Mode, $3.0 \leq V_{IN} \leq 5.5$, Active No Load Current	—	0.3	0.6	mA
		2x Mode, $3.0 \leq V_{IN} \leq 5.5$, Active No Load Current	—	2	5	
I _{SHDN}	Shutdown Current	CTL1, CTL2 and CTL3 = 0	—	—	1	μA
I _{DX}	I _{SINK} Current Accuracy (Note 5)	—	19	20	21	mA
I _{D-Match}	Current Matching Between Any Two Current Sink Inputs (Note 6)	V _F : D1:D9 = 3.6V	—	1	2	%
R _{OUT}	Open Loop V _{OUT} Resistance	1x Mode	—	0.5	—	Ω
		2 x Mode	—	4.5	—	
V _{TH}	1x to 2x Transition Threshold at Any I _{SINK} Pin	I _{DX} = 20mA	—	150	—	mV
V _{HS}	Mode Transition Hysteresis	—	—	250	—	mV
t _{SS}	Soft-Start Time	—	—	100	—	μs
f _{sw}	Switching Frequency	—	—	1.2	—	MHz
V _{CTL1, 2, 3 (L)}	CTL1, 2, 3 Threshold Low	V _{IN} = 2.7V	—	—	0.4	V
V _{CTL1, 2, 3 (H)}	CTL1, 2, 3 Threshold High	V _{IN} = 5.5V	1.4	—	—	V
t _{CTL1, 2, 3}	CTL1, 2, 3 Off Timeout	—	—	—	200	μs
UVLO	V _{IN} Under-Voltage Lockout	—	1.8	2	2.2	V
I _{CTL1, 2, 3}	CTL1, 2, 3 Input Leakage	—	-1	—	1	μA
T _{SHDN}	Thermal Shutdown Protection	—	—	+160	—	°C
T _{HYS}	Thermal Shutdown Hysteresis	—	—	+10	—	°C
θ _{JA}	Thermal Resistance Junction-to-Ambient	QFN3030-20 (Note 7)	—	48	—	°C/W

Notes: 5. Determined by the average current levels of all active channels.

6. Defined as the deviation of any sink current from the average of all active current channels.

7. Device mounted on FR-4 substrate, 2" x 2", 2oz copper, double-sided PC board, with minimum recommended pad on top layer and 4 vias to bottom layer.

Typical Performance Characteristics

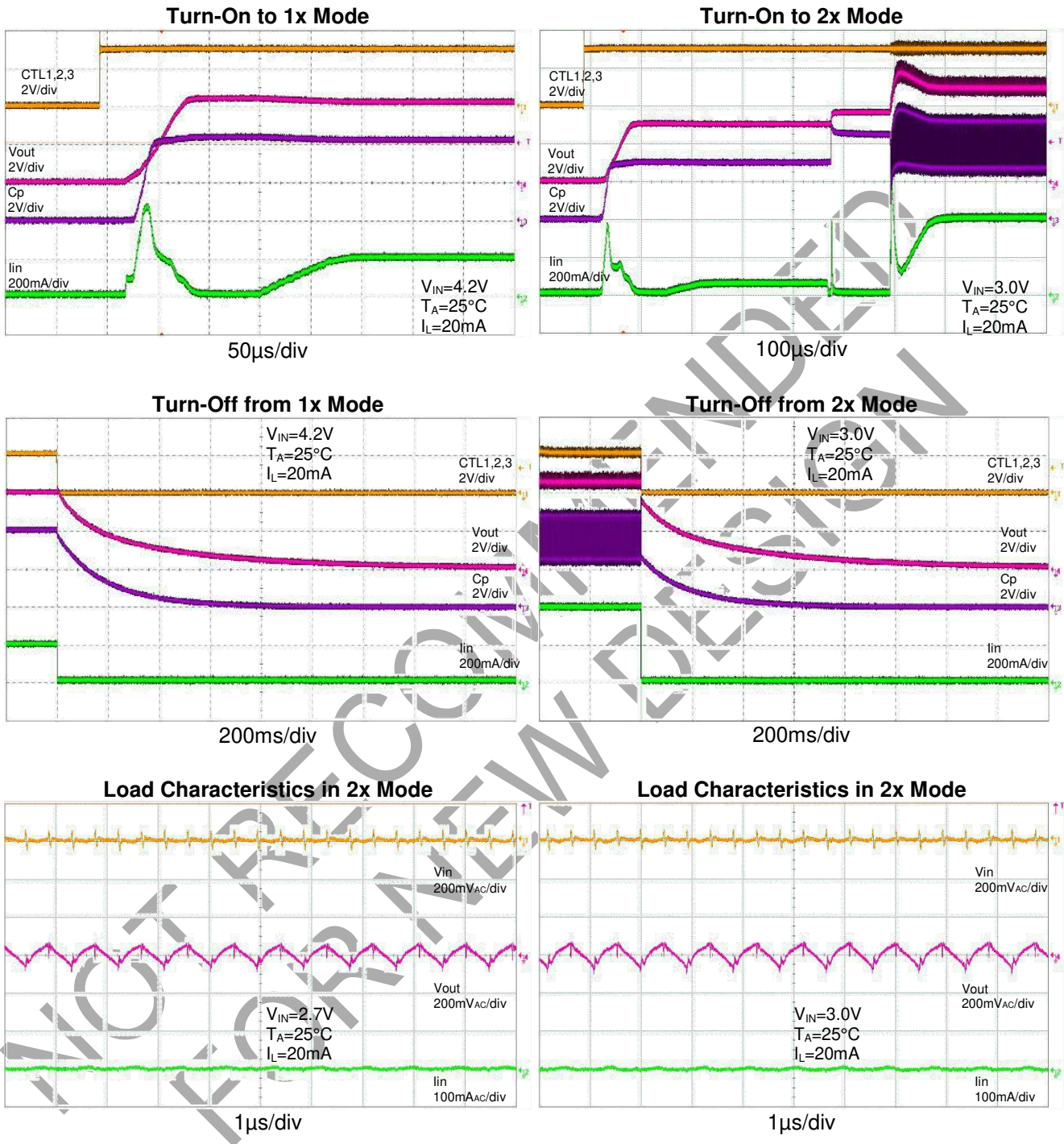

Typical Performance Characteristics (continued)

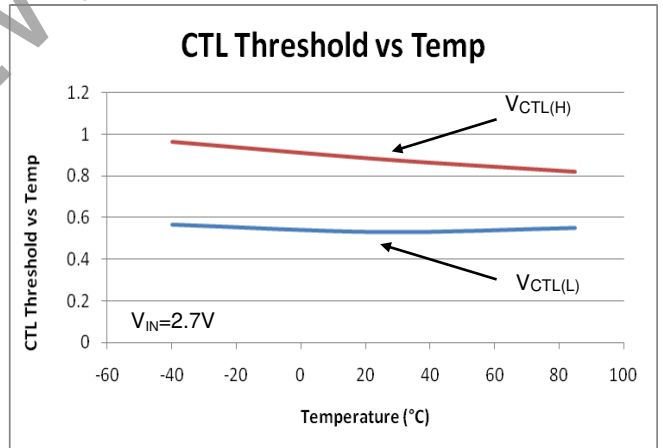
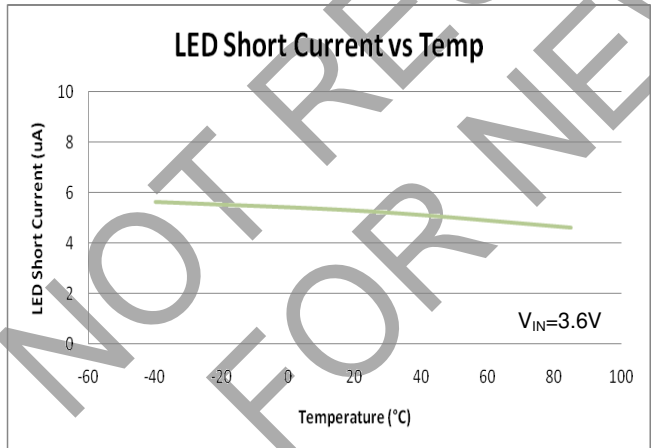
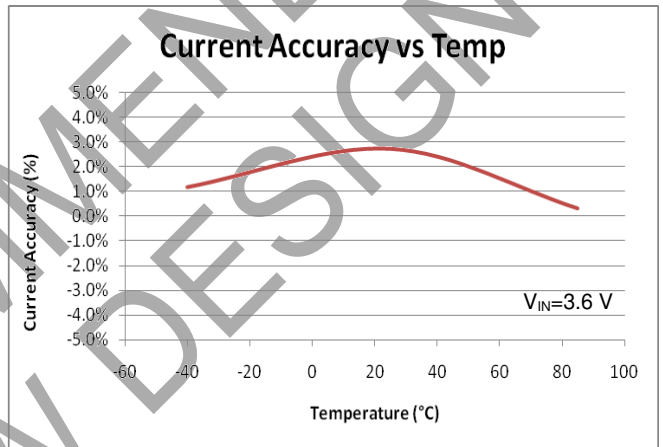
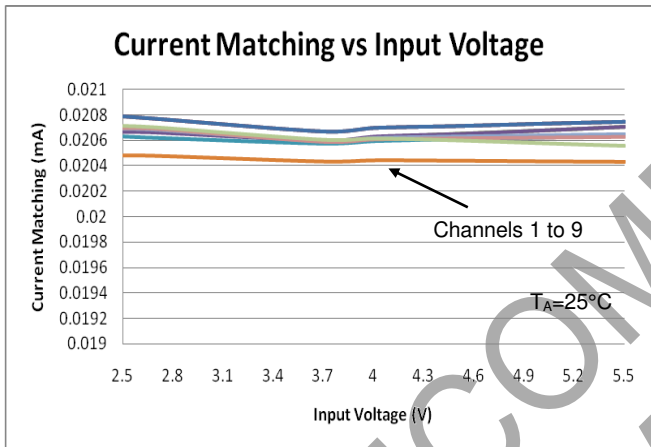
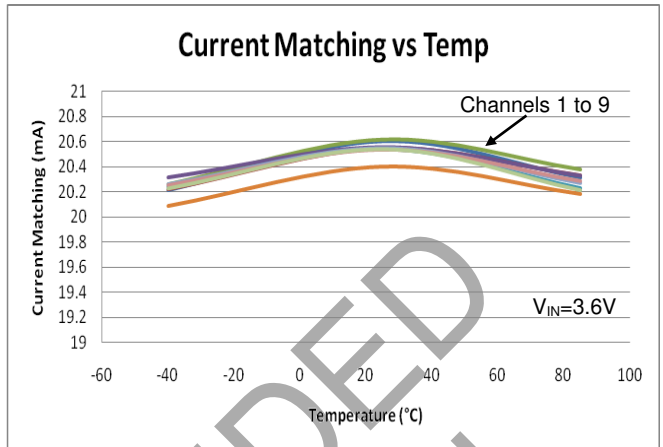
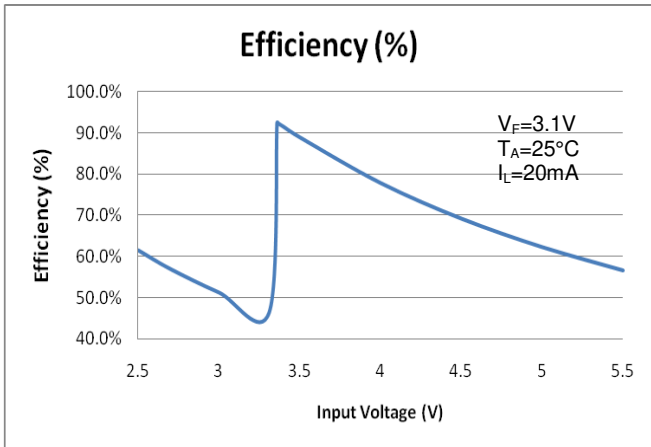

Function Description

The AL3159 is a dual-mode high efficiency charge pump (1x and 2x) device, driving nine LED channels with three simple logic control inputs, intended for white LED backlight applications. An internal comparator circuit compares the voltage at each constant current sink input against a reference voltage. To ensure maximum power efficiency, the most appropriate switching mode (1x and 2x) is automatically selected.

The AL3159 requires only three external components: one 1 μ F ceramic flying capacitor (C₁) for the charge pump, one 2.2 μ F ceramic input capacitor (C_{IN}), and one 2.2 μ F ceramic charge pump output capacitor (C_{OUT}).

Each output channel of the AL3159 can drive nine individual LEDs with a maximum current of fixed manufacture setting (20mA or 30mA) per channel. These can be paralleled to give a total maximum output current of 270mA.

CTL <3:1>	LED ON/OFF CONTROL
000	ALL OFF
001	LED1 to LED2 ON
010	LED3 to LED5 ON
011	LED6 to LED9 ON
100	LED9 ON
101	LED6 to LED8 ON
110	LED1 to LED5 ON
111	ALL ON

Disabled Current Sinks

Unused current channels must be disabled by connecting the sinks to V_{OUT} with only a small sense current flowing through the disabled channel.

Soft-Start

Soft-start is incorporated to prevent excessive inrush current during power-up, mode switching, and transitioning out of stand-by mode.

Short-Circuit Protection

Short-circuit protection function is incorporated to prevent excessive load current when either flying cap terminals or output pin electrically tied to a very lower voltage or ground.

Over-Voltage Protection

Over-voltage protection function is incorporated to limit the output voltage under a safe value to avoid on-chip device breakdown.

Under-Voltage Lockout

Under-voltage lockout feature disables the device when the input voltage drops below UVLO threshold.

Thermal Auto Shutdown

When the die temperature exceeds the thermal limit, the device will be disabled and enter stand-by mode. The operation resumes whenever the die cools off sufficiently.

Ordering Information

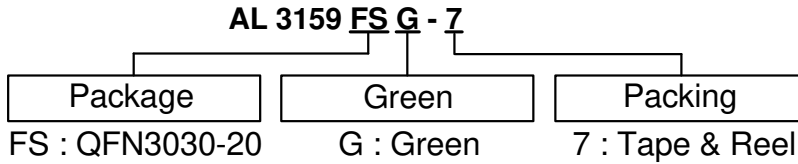

Part Number	Part Number Suffix	Package Code	Package (Note 8)	Packing	
				Qty.	Carrier
AL3159FSG-7	-7	FS	QFN3030-20	3000	7" Tape & Reel

Note: 8. Pad layout as shown on Diodes Incorporated's suggested pad layout, which can be found on our website at <http://www.diodes.com/package-outlines.html>.

Marking Information

QFN3030-20

(Top View)

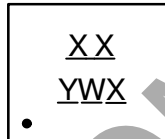

XX : B9 : AL3159
Y : Year : 0 to 9 (ex: 2 = 2022)
W : Week : A to Z : week 1 to 26;
a to z : week 27 to 52; z represents week 52 and 53
X : A to Z : Green

Part Number	Package	Identification Code
AL3159FSG-7	QFN3030-20	B9

NOT RECOMMENDED FOR NEW DESIGN

IMPORTANT NOTICE

1. DIODES INCORPORATED (Diodes) AND ITS SUBSIDIARIES MAKE NO WARRANTY OF ANY KIND, EXPRESS OR IMPLIED, WITH REGARDS TO ANY INFORMATION CONTAINED IN THIS DOCUMENT, INCLUDING, BUT NOT LIMITED TO, THE IMPLIED WARRANTIES OF MERCHANTABILITY, FITNESS FOR A PARTICULAR PURPOSE OR NON-INFRINGEMENT OF THIRD PARTY INTELLECTUAL PROPERTY RIGHTS (AND THEIR EQUIVALENTS UNDER THE LAWS OF ANY JURISDICTION).
2. The Information contained herein is for informational purpose only and is provided only to illustrate the operation of Diodes' products described herein and application examples. Diodes does not assume any liability arising out of the application or use of this document or any product described herein. This document is intended for skilled and technically trained engineering customers and users who design with Diodes' products. Diodes' products may be used to facilitate safety-related applications; however, in all instances customers and users are responsible for (a) selecting the appropriate Diodes products for their applications, (b) evaluating the suitability of Diodes' products for their intended applications, (c) ensuring their applications, which incorporate Diodes' products, comply the applicable legal and regulatory requirements as well as safety and functional-safety related standards, and (d) ensuring they design with appropriate safeguards (including testing, validation, quality control techniques, redundancy, malfunction prevention, and appropriate treatment for aging degradation) to minimize the risks associated with their applications.
3. Diodes assumes no liability for any application-related information, support, assistance or feedback that may be provided by Diodes from time to time. Any customer or user of this document or products described herein will assume all risks and liabilities associated with such use, and will hold Diodes and all companies whose products are represented herein or on Diodes' websites, harmless against all damages and liabilities.
4. Products described herein may be covered by one or more United States, international or foreign patents and pending patent applications. Product names and markings noted herein may also be covered by one or more United States, international or foreign trademarks and trademark applications. Diodes does not convey any license under any of its intellectual property rights or the rights of any third parties (including third parties whose products and services may be described in this document or on Diodes' website) under this document.
5. Diodes' products are provided subject to Diodes' Standard Terms and Conditions of Sale (<https://www.diodes.com/about/company/terms-and-conditions/terms-and-conditions-of-sales/>) or other applicable terms. This document does not alter or expand the applicable warranties provided by Diodes. Diodes does not warrant or accept any liability whatsoever in respect of any products purchased through unauthorized sales channel.
6. Diodes' products and technology may not be used for or incorporated into any products or systems whose manufacture, use or sale is prohibited under any applicable laws and regulations. Should customers or users use Diodes' products in contravention of any applicable laws or regulations, or for any unintended or unauthorized application, customers and users will (a) be solely responsible for any damages, losses or penalties arising in connection therewith or as a result thereof, and (b) indemnify and hold Diodes and its representatives and agents harmless against any and all claims, damages, expenses, and attorney fees arising out of, directly or indirectly, any claim relating to any noncompliance with the applicable laws and regulations, as well as any unintended or unauthorized application.
7. While efforts have been made to ensure the information contained in this document is accurate, complete and current, it may contain technical inaccuracies, omissions and typographical errors. Diodes does not warrant that information contained in this document is error-free and Diodes is under no obligation to update or otherwise correct this information. Notwithstanding the foregoing, Diodes reserves the right to make modifications, enhancements, improvements, corrections or other changes without further notice to this document and any product described herein. This document is written in English but may be translated into multiple languages for reference. Only the English version of this document is the final and determinative format released by Diodes.
8. Any unauthorized copying, modification, distribution, transmission, display or other use of this document (or any portion hereof) is prohibited. Diodes assumes no responsibility for any losses incurred by the customers or users or any third parties arising from any such unauthorized use.
9. This Notice may be periodically updated with the most recent version available at <https://www.diodes.com/about/company/terms-and-conditions/important-notice>

DIODES is a trademark of Diodes Incorporated in the United States and other countries.
The Diodes logo is a registered trademark of Diodes Incorporated in the United States and other countries.
© 2022 Diodes Incorporated. All Rights Reserved.

www.diodes.com