

Bridgelux® V22 F90 BBBL Array Series

Product Data Sheet DS449-1



Introduction

V Series

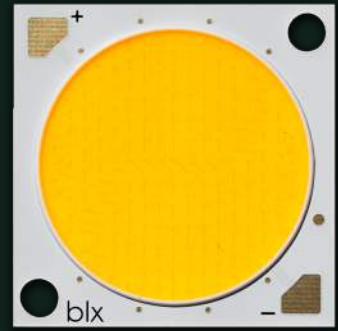

The V Series™ LED Array products deliver high quality light in a compact and cost-effective solid-state lighting package. These chip on board (CoB) arrays can be efficiently driven up to two times the nominal drive current, enabling design flexibility not previously possible. These high flux density light sources are designed to support a wide range of high quality, low cost directional luminaires and replacement lamps for both interior and exterior commercial and residential applications.

The F90 V Series COB is a high efficacy product that uses narrow band red phosphor to significantly improve the spectrum efficacy. The improved spectrum efficacy results in the 90 CRI product of the F90 Series delivering better or equivalent efficacy as that of our traditional 80 CRI V Series product.

The V22 LED Array is available in a variety of electrical, CCT, and CRI combinations providing substantial design flexibility and energy efficiency advantages.

Lighting system designs incorporating these LED arrays deliver increased system level efficacy and a longer service life. Typical applications include replacement lamps and task, accent, spot, track, wide area, security, wall packs and down lights.

Features

- Efficacy of 183 lm/W typical, 3000K 90 CRI
- Wide selection of CCT options (2700K-5000K) with minimum 90 CRI options
- Uniform high-quality illumination
- 2 and 3 SDCM binning options (2700K – 4000K)
- Forward voltage bin codes and backside marking
- Instant light with unlimited dimming
- 5-Year warranty

Benefits

- Enables high efficiency lighting systems and lower operating costs
- Supports the trend toward luminaire miniaturization and delivers enhanced optical control
- Design flexibility for a broad range of lighting applications
- Clean white light without pixelation
- Uniform consistent white light
- Design flexibility for multi-source applications
- Easy to use with daylight and motion sensors to increase energy savings
- Design with confidence



Contents

Product Feature Map	2
Product Nomenclature	2
Product Selection Guide	3
European Product Registry for Energy Labeling	5
Performance at Commonly Used Drive Currents	6
Electrical Characteristics	8
Eye Safety	9
Absolute Maximum Ratings	10
Performance Curves	11
Typical Radiation Pattern	12
Typical Color Spectrum	13
Mechanical Dimensions	14
Color Binning Information	15
Packaging and Labeling	16
Design Resources	18
Precautions	18
Disclaimers	18
About Bridgelux	19

Product Feature Map

Bridgelux arrays are fully engineered devices that provide consistent thermal and optical performance on an engineered mechanical platform. The V Series arrays are the most compact CoB devices across all of Bridgelux's LED Array products.

The arrays incorporate several features to simplify design integration and assembly. Please visit www.bridgelux.com for more information on the V Series family of products.

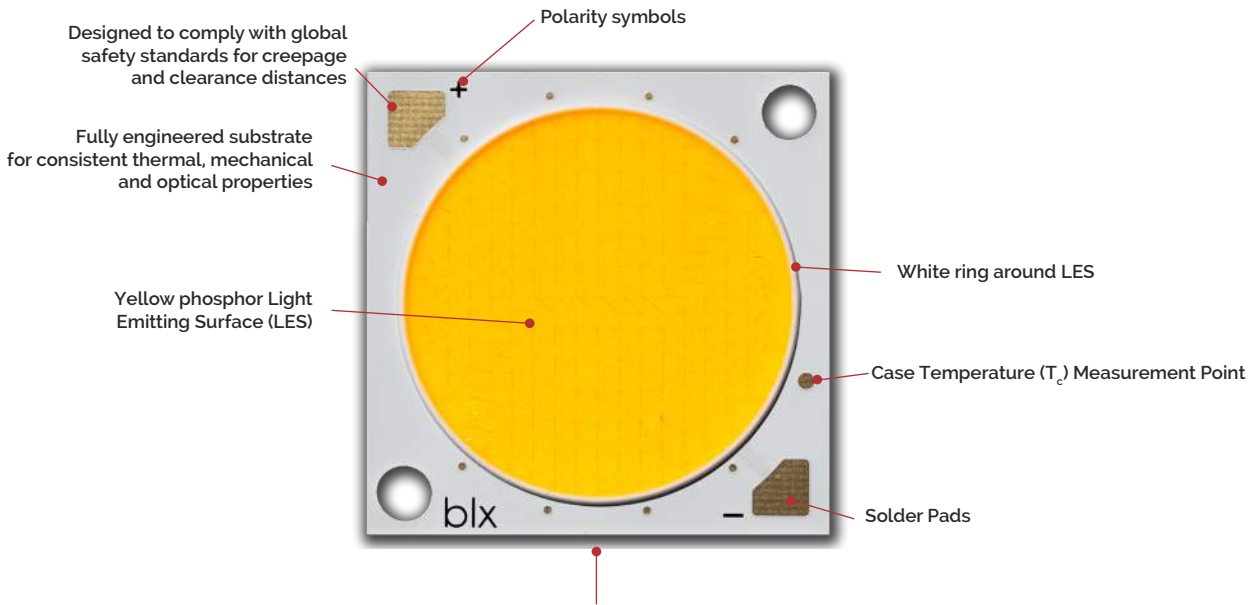

Note: Part number and lot codes are scribed on back of array

Product Nomenclature

The part number designation for Bridgelux V Series LED arrays is explained as follows:

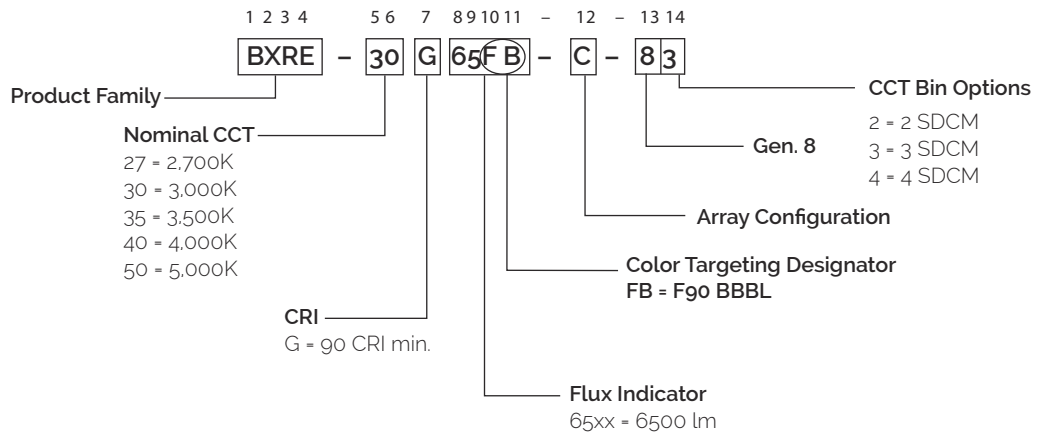

Product Selection Guide

The following product configurations are available:

Table 1: Selection Guide, Pulsed Measurement Data ($T_j = T_c = 25^\circ\text{C}$)

Part Number	Nominal CCT ¹ (K)	CRI ²	Nominal Drive Current ³ (mA)	Typical Pulsed Flux ^{4,5,6} $T_c = 25^\circ\text{C}$ (lm)	Minimum Pulsed Flux ^{6,7} $T_c = 25^\circ\text{C}$ (lm)	Typical V_f (V)	Typical Power (W)	Typical Efficacy (lm/W)
BXRE-27G65FB-B-8x	2700	90	950	8804	7923	51.6	49.0	180
BXRE-27G65FB-C-8x	2700	90	1200	11085	9977	52.0	62.4	178
BXRE-30G65FB-B-8x	3000	90	950	8983	8085	51.6	49.0	183
BXRE-30G65FB-C-8x	3000	90	1200	11312	10180	52.0	62.4	181
BXRE-35G65FB-B-8x	3500	90	950	8934	8041	51.6	49.0	182
BXRE-35G65FB-C-8x	3500	90	1200	11250	10125	52.0	62.4	180
BXRE-40G65FB-B-8x	4000	90	950	9023	8120	51.6	49.0	184
BXRE-40G65FB-C-8x	4000	90	1200	11361	10225	52.0	62.4	182

Notes for Table 1:

- Nominal CCT as defined by ANSI C78.377-2011.
- CRI values are minimums and tested at $T_j = T_c = 85^\circ\text{C}$. Minimum R9 value for 90 CRI products is 50. Bridgelux maintains a ± 3 tolerance on CRI and R9 values.
- Drive current is referred to as nominal drive current.
- Products tested under pulsed condition (10ms pulse width) at nominal test current where T_j (junction temperature) - T_c (case temperature) = 25°C .
- Typical performance values are provided as a reference only and are not a guarantee of performance.
- Bridgelux maintains a $\pm 7\%$ tolerance on flux measurements.
- Minimum flux values at the nominal test current are guaranteed by 100% test.

Product Selection Guide

Table 2: Selection Guide, Stabilized DC Performance ($T_c = 85^\circ\text{C}$)^{4,5}

Part Number	Nominal CCT ¹ (K)	CRI ²	Nominal Drive Current ³ (mA)	Typical DC Flux ^{4,5} $T_c = 85^\circ\text{C}$ (lm)	Minimum DC Flux ⁶ $T_c = 85^\circ\text{C}$ (lm)	Typical V_f (V)	Typical Power (W)	Typical Efficacy (lm/W)
BXRE-27G65FB-B-8x	2700	90	950	8099	7289	50.4	479	169
BXRE-27G65FB-C-8x	2700	90	1200	10199	9179	50.8	61.0	167
BXRE-30G65FB-B-8x	3000	90	950	8265	7438	50.4	47.9	173
BXRE-30G65FB-C-8x	3000	90	1200	10407	9366	50.8	61.0	171
BXRE-35G65FB-B-8x	3500	90	950	8219	7397	50.4	47.9	172
BXRE-35G65FB-C-8x	3500	90	1200	10350	9315	50.8	61.0	170
BXRE-40G65FB-B-8x	4000	90	950	8301	7471	50.4	47.9	173
BXRE-40G65FB-C-8x	4000	90	1200	10452	9407	50.8	61.0	171

Notes for Table 2:

- Nominal CCT as defined by ANSI C78.377-2011.
- CRI values are minimums and tested at $T_j = T_c = 85^\circ\text{C}$. Minimum Rg value for 90 CRI products is 50.
- Drive current is referred to as nominal drive current.
- Typical stabilized DC performance values are provided as reference only and are not a guarantee of performance.
- Typical performance is estimated based on operation under DC (direct current) with LED array mounted onto a heat sink with thermal interface material and the case temperature maintained at 85°C . Based on Bridgelux test setup, values may vary depending on the thermal design of the luminaire and/or the exposed environment to which the product is subjected.
- Minimum flux values at elevated temperatures are provided for reference only and are not guaranteed by 100% production testing. Based on Bridgelux test setup, values may vary depending on the thermal design of the luminaire and/or the exposed environment to which the product is subjected.

European Product Registry for Energy Labeling

The European Product Registry for Energy Labeling (EPREL) is defined in the EU Regulation 2017/1369 to provide important energy efficiency information to consumers. Together with Energy Labeling Regulation ELR (EU) 2019/2015 which was amended by regulation (EU) 2021/340 for energy labelling of light sources, manufacturers are required to declare an energy class based on key technical specifications from each of their product and register it in an open data base managed by EPREL. It is now a legal requirement for a vendor of light sources to upload information about their products into the EPREL database before placing these products on the market in the EU.

Table 3 below provides a list of part numbers that are in compliance with ELR and are currently listed in the EPREL database.

At Bridgelux, we are fully committed to supplying products that are compliant with pertinent laws, rules, and obligation imposed by relevant government bodies including the European Energy Labeling regulation. Customers can use these products with full confidence for any projects that fall under the ELR.

Table 3: Part numbers registered in European Product Registry for Energy Labeling

PART NUMBER ¹	CCT (K)	CRI	Current ² (mA)	Vf (V)	Useful flux ³ (Φ_{use}) at 85C (lm)	Power (W)	Efficacy (lm/W)	Energy efficiency class ⁴	Registration No	URL to Product Information Sheet in EPREL Database
BXRE-27G65FB-B-83	2700	90	2340	57.0	17956	133	135	E	1336728	https://eprelec.europa.eu/qr/1336728
BXRE-27G65FB-C-83	2700	90	2700	57.0	20808	154	135	E	1336729	https://eprelec.europa.eu/qr/1336729
BXRE-30G65FB-B-83	3000	90	2340	57.0	18322	133	137	E	1336733	https://eprelec.europa.eu/qr/1336733
BXRE-30G65FB-C-83	3000	90	2700	57.0	21233	154	138	E	1336734	https://eprelec.europa.eu/qr/1336734
BXRE-35G65FB-B-83	3500	90	2340	57.0	18295	133	137	E	1332534	https://eprelec.europa.eu/qr/1332534
BXRE-35G65FB-C-83	3500	90	2700	57.0	21122	154	137	E	1332535	https://eprelec.europa.eu/qr/1332535
BXRE-40G65FB-B-83	4000	90	2340	57.0	18688	133	140	E	1336740	https://eprelec.europa.eu/qr/1336740
BXRE-40G65FB-C-83	4000	90	2700	57.0	21657	154	141	E	1336741	https://eprelec.europa.eu/qr/1336741

Notes for Table 3:

1. All device listed here must be disposed as e-waste upon its end of life according to local country guideline in each country.
2. For information on performance values at alternative drive conditions, please refer to the Product Selection Guide, Absolute Maximum Rating Table and Performance Curves in this data sheet.
3. For a definition of useful luminous flux (Φ_{use}), please see the ELR regulations at <https://tinyurl.com/4b6zvt4m>.
4. EPREL requires an arrow symbol containing the letter of the energy efficiency class to be displayed, on technical promotional material. Refer to this energy efficiency class column for specific energy efficiency class on each part number.

Performance at Commonly Used Drive Currents

V Series LED arrays are tested to the specifications shown using the nominal drive currents in Table 1. V Series may also be driven at other drive currents dependent on specific application design requirements. The performance at any drive current can be derived from the current vs. voltage characteristics shown in Figures 1 & 2 and the flux vs. current characteristics shown in Figures 3 & 4. The performance at commonly used drive currents is summarized in Table 4.

Table 4: Product Performance at Commonly Used Drive Currents

Part Number	CRI	Drive Current ¹ (mA)	Typical V_f $T_c = 25^\circ\text{C}$ (V)	Typical Power $T_c = 25^\circ\text{C}$ (W)	Typical Flux ² $T_c = 25^\circ\text{C}$ (lm)	Typical DC Flux ³ $T_c = 85^\circ\text{C}$ (lm)	Typical Efficacy $T_c = 25^\circ\text{C}$ (lm/W)
BXRE-27G65FB-B-8x	90	475	49.4	23.4	4532	4228	193
		725	50.6	36.7	6806	6305	186
		950	51.6	49.0	8804	8099	180
		1170	52.6	61.5	10712	9783	174
		1900	55.6	105.6	16727	14849	158
		2340	57.2	133.8	19602	17053	147
BXRE-27G65FB-C-8x	90	600	49.6	29.7	5717	5334	192
		900	50.8	45.7	8437	7819	185
		1200	52.0	62.4	11085	10199	178
		1440	52.9	76.2	13153	12024	173
		2400	56.2	134.9	20964	18610	155
		2700	57.2	154.3	23255	20426	151
BXRE-30G65FB-B-8x	90	475	49.4	23.4	4624	4314	197
		725	50.6	36.7	6945	6434	189
		950	51.6	49.0	8983	8265	183
		1170	52.6	61.5	10931	9983	178
		1900	55.6	105.6	17068	15152	162
		2340	57.2	133.8	20002	17401	150
BXRE-30G65FB-C-8x	90	600	49.6	29.7	5833	5443	196
		900	50.8	45.7	8609	7979	188
		1200	52.0	62.4	11312	10407	181
		1440	52.9	76.2	13421	12270	176
		2400	56.2	134.9	21392	18990	159
		2700	57.2	154.3	23729	20843	154
BXRE-35G65FB-B-8x	90	475	49.4	23.4	4599	4291	196
		725	50.6	36.7	6907	6399	188
		950	51.6	49.0	8934	8219	182
		1170	52.6	61.5	10871	9928	177
		1900	55.6	105.6	16975	15069	161
		2340	57.2	133.8	19893	17306	149
BXRE-35G65FB-C-8x	90	600	49.6	29.7	5802	5413	195
		900	50.8	45.7	8562	7935	187
		1200	52.0	62.4	11250	10350	180
		1440	52.9	76.2	13348	12203	175
		2400	56.2	134.9	21275	18886	158
		2700	57.2	154.3	23600	20729	153

Notes for Table 4:

1. Alternate drive currents in Table 4 are provided for reference only and are not a guarantee of performance.
2. Bridgelux maintains a $\pm 7\%$ tolerance on flux measurements.
3. Typical stabilized DC performance values are provided as reference only and are not a guarantee of performance.

Performance at Commonly Used Drive Currents

Table 4: Product Performance at Commonly Used Drive Currents (Continued)

Part Number	CRI	Drive Current ¹ (mA)	Typical V _f T _c = 25°C (V)	Typical Power T _c = 25°C (W)	Typical Flux ² T _c = 25°C (lm)	Typical DC Flux ³ T _c = 85°C (lm)	Typical Efficacy T _c = 25°C (lm/W)
BXRE-40G65FB-B-8x	90	475	49.4	23.4	4645	4333	198
		725	50.6	36.7	6975	6462	190
		950	51.6	49.0	9023	8301	184
		1170	52.6	61.5	10979	10026	178
		1900	55.6	105.6	17143	15219	162
		2340	57.2	133.8	20090	17478	150
BXRE-40G65FB-C-8x	90	600	49.6	29.7	5859	5466	197
		900	50.8	45.7	8647	8014	189
		1200	52.0	62.4	11361	10452	182
		1440	52.9	76.2	13480	12324	177
		2400	56.2	134.9	21486	19073	159
		2700	57.2	154.3	23833	20934	154

Notes for Table 4:

1. Alternate drive currents in Table 4 are provided for reference only and are not a guarantee of performance.
2. Bridgelux maintains a ± 7% tolerance on flux measurements.
3. Typical stabilized DC performance values are provided as reference only and are not a guarantee of performance.

Electrical Characteristics

Table 5: Electrical Characteristics

Part Number	Drive Current (mA)	Forward Voltage Pulsed, $T_c = 25^\circ\text{C}$ (V) ^{1, 2, 3, 8}			Typical Coefficient of Forward Voltage ⁴ $\Delta V_f / \Delta T_c$ (mV/ $^\circ\text{C}$)	Typical Thermal Resistance Junction to Case ^{5,6} R_{j-c} ($^\circ\text{C}/\text{W}$)	Driver Selection Voltages ⁷ (V)	
		Minimum	Typical	Maximum			V_f Min. Hot $T_c = 95^\circ\text{C}$ (V)	V_f Max. Cold $T_c = -40^\circ\text{C}$ (V)
BXRE-xxx65FB-B-8x	950	48.5	51.6	54.7	-17	0.07	47.3	55.8
	2340	53.7	57.2	60.6	-19	0.13	52.4	61.8
BXRE-xxx65FB-C-8x	1200	48.9	52.0	55.1	-17	0.08	47.7	56.2
	2700	53.7	57.2	60.6	-19	0.15	52.4	61.8

Notes for Table 5:

- Parts are tested in pulsed conditions. $T_c = 25^\circ\text{C}$. Pulse width is 10ms.
- Voltage minimum and maximum are provided for reference only and are not a guarantee of performance.
- Bridgelux maintains a tester tolerance of $\pm 0.10\text{V}$ on forward voltage measurements.
- Typical coefficient of forward voltage tolerance is $\pm 0.1\text{mV}$ for nominal current.
- Thermal resistance values are based from test data of a 3000K 90 CRI product.
- Thermal resistance value was calculated using total electrical input power; optical power was not subtracted from input power. The thermal interface material used during testing is not included in the thermal resistance value.
- V_f min hot and max cold values are provided as reference only and are not guaranteed by test. These values are provided to aid in driver design and selection over the operating range of the product.
- This product has been designed and manufactured per IEC 62031:2018. This product has passed dielectric withstand voltage testing at 1140 V. The working voltage designated for the insulation is 70V d.c. The maximum allowable voltage across the array must be determined in the end product application.

Eye Safety

Table 6: Eye Safety Risk Group (RG) Classifications

Part Number	Drive Current (mA)	CCT ³	
		2700K/3000K/3500K	4000K ²
BXRE-xxx65F0-B-8x	2340	RG1	RG1
BXRE-xxx65F0-C-8x	2500	RG1	RG1
	2700	RG1	RG2

Notes for Table 6:

1. Eye safety classification for the use of Bridgelux V Series LED arrays is in accordance with specification IEC/TR 62778: Application of IEC 62471 for the assessment of blue light hazard to light sources and luminaires.
2. For products classified as RG2 at 4000K, Ethr= 1980 lx.
3. Please contact your Bridgelux sales representative for Ethr values at specific drive currents and CCTs not listed.

Absolute Maximum Ratings

Table 7: Maximum Ratings

Parameter	Maximum Rating	
LED Junction Temperature (T_j)	150°C	
Storage Temperature ¹	-40°C to +95°C	
Operating Case Temperature ² (T_c)	95°C	
Soldering Temperature ³	300°C or lower for a maximum of 6 seconds	
	BXRE-xxx65FB-B-8x	BXRE-xxx65FB-C-8x
Maximum Drive Current ⁴	2340 mA at $\leq 85^\circ\text{C}$ 1755 mA at 95°C	2700 mA at $\leq 85^\circ\text{C}$ 2025 mA at 95°C
Maximum Peak Pulsed Drive Current ⁵	3350 mA	3870 mA
Maximum Reverse Voltage ⁶	-90V	-90V

Notes for Table 7:

1. The Fg0 product is robust enough to pass our internal humidity test but it is still more sensitive compared to regular LED array product. The product needs to be stored in a dry environment. It is not recommended to use the product in a damp environment that directly exposes it to moisture.
2. For IEC 62717 requirement, please consult your Bridgelux sales representative.
3. Refer to Bridgelux Application Note AN101: Handling and Assembly of Bridgelux V Series LED Arrays
4. Arrays may be driven at higher currents however lumen maintenance may be reduced and warranty will not apply.
5. Bridgelux recommends a maximum duty cycle of 10% and pulse width of 20 ms when operating LED Arrays at maximum peak pulsed current specified. Maximum peak pulsed currents indicate values where LED Arrays can be driven without catastrophic failures.
6. Light emitting diodes are not designed to be driven in reverse voltage and will not produce light under this condition. Maximum rating provided for reference only.

Performance Curves

Figure 1: V22B Drive Current vs. Voltage

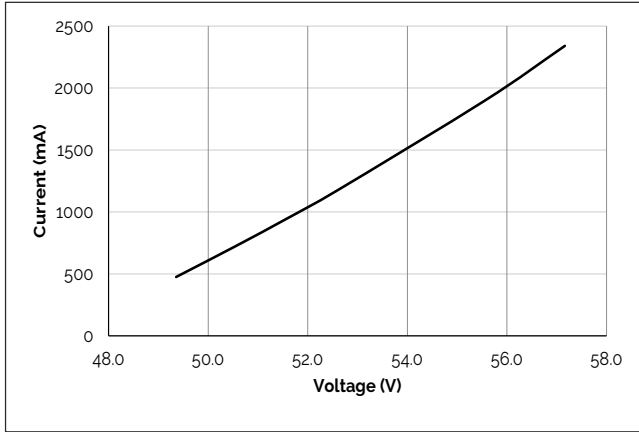

Figure 2: V22C Drive Current vs. Voltage

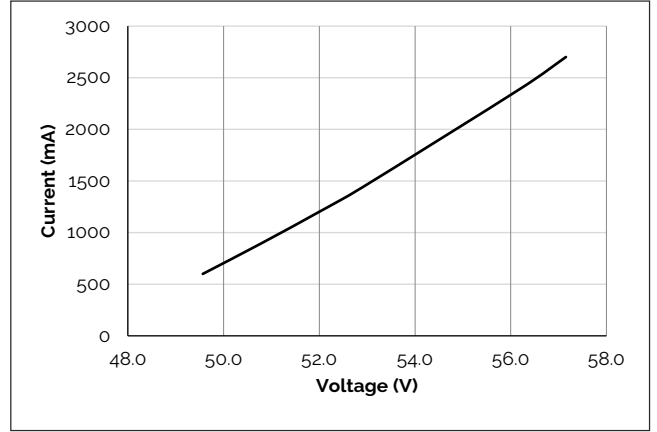

Figure 3: V22B Typical Relative Flux vs. Current

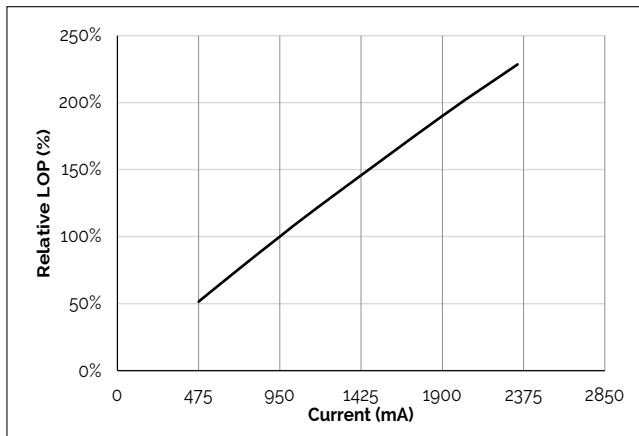

Figure 4: V22C Typical Relative Flux vs. Current

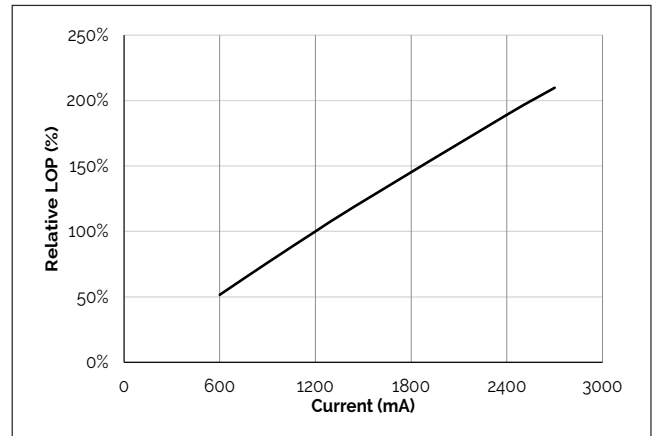

Figure 5: Typical DC Flux vs. Case Temperature

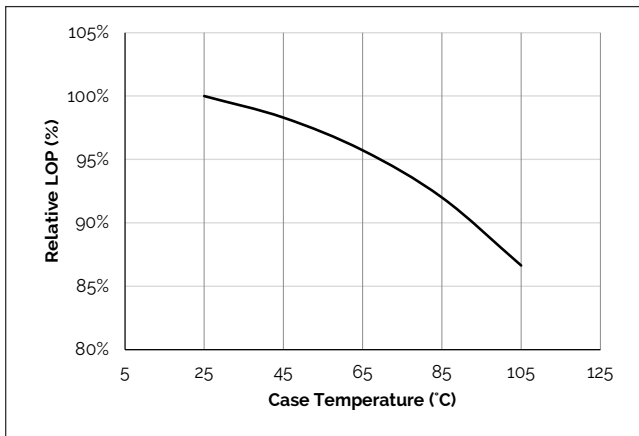
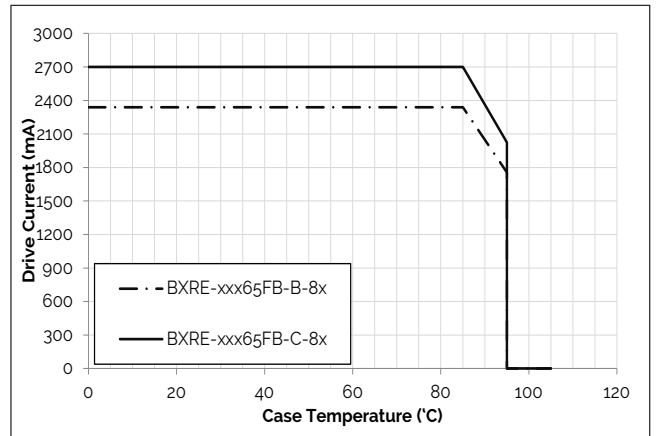

Figure 6: Derating Curve



Notes for Figures 1-6:

1. Bridgelux does not recommend driving high power LEDs at low currents. Doing so may produce unpredictable results. Pulse width modulation (PWM) is recommended for dimming effects.
2. Products tested under pulsed condition (10ms pulse width) at nominal test current where T_j (junction temperature) - T_c (case temperature) = 25°C.

Typical Radiation Pattern

Figure 7: Typical Spatial Radiation Pattern

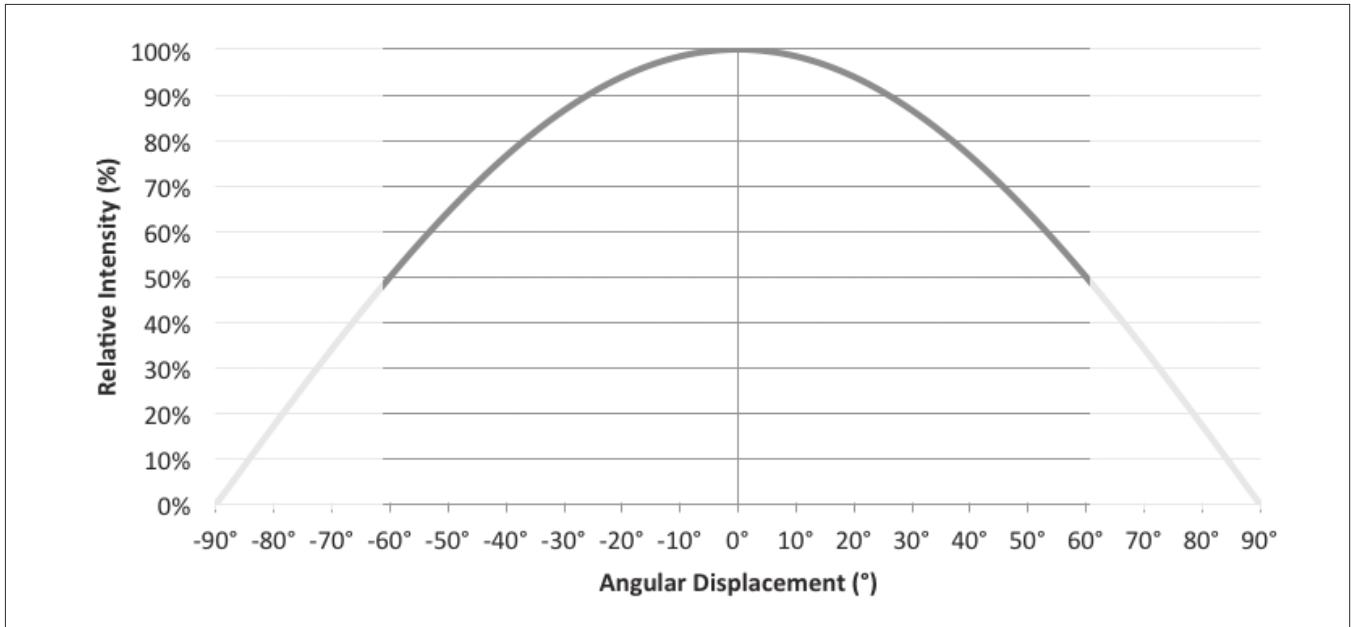

Notes for Figure 7:

1. Typical viewing angle is 120°.
2. The viewing angle is defined as the off axis angle from the centerline where intensity is ½ of the peak value.

Figure 8: Typical Polar Radiation Pattern

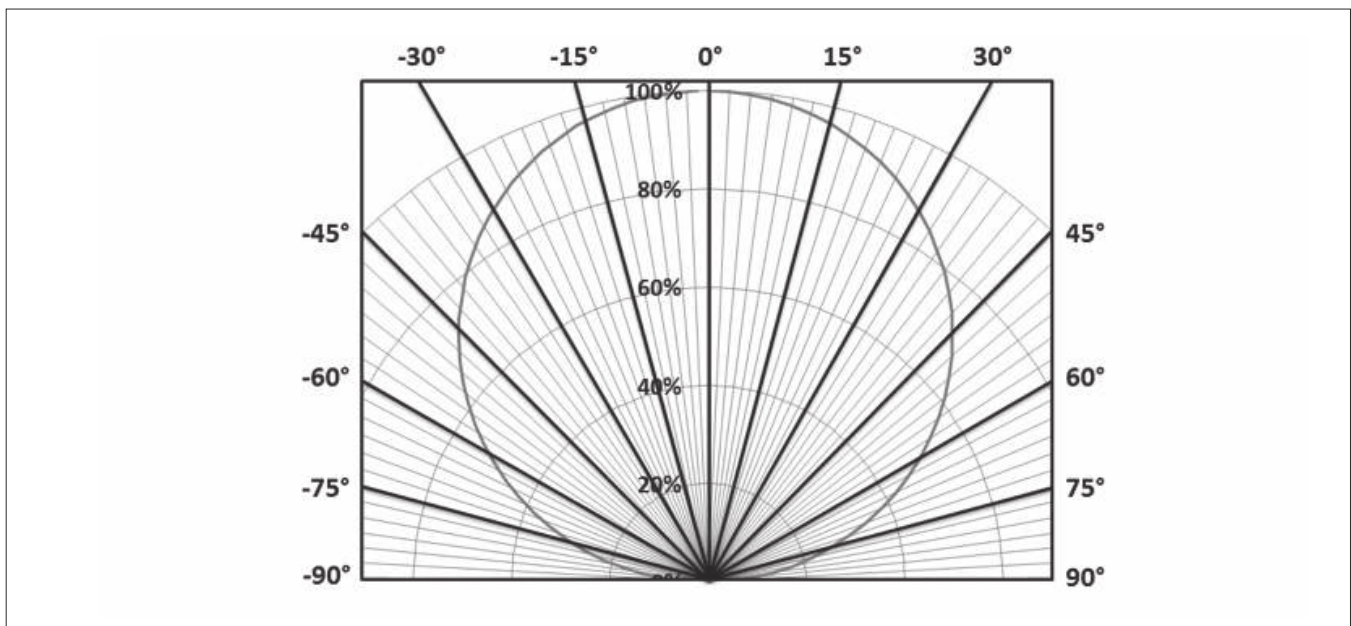

Typical Color Spectrum

Figure 9: Typical Color Spectrum

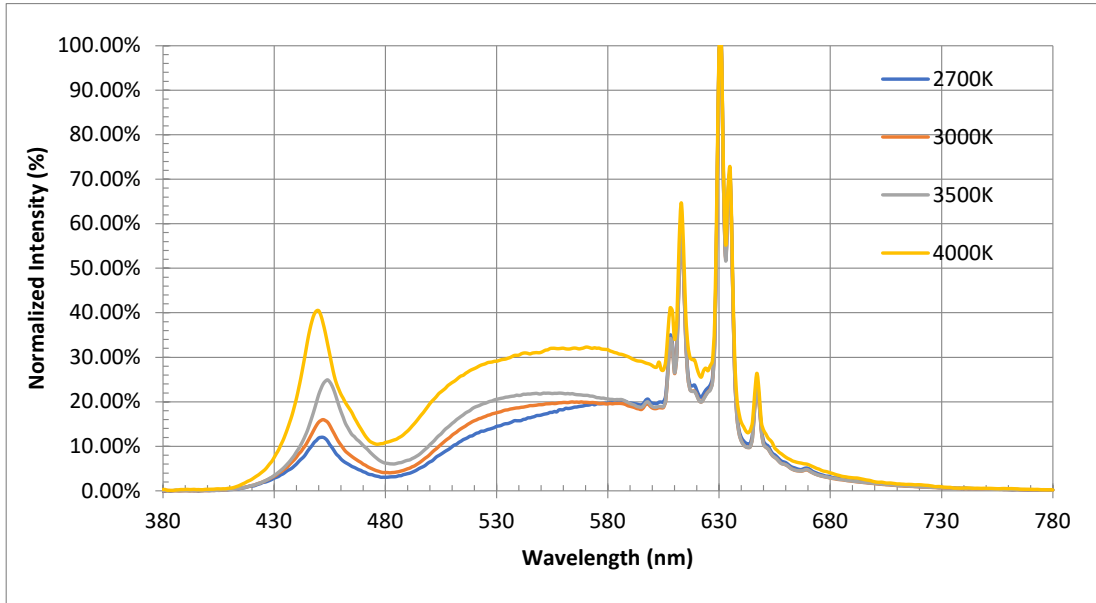

Notes for Figure 9:

1. Color spectra measured at nominal current for $T_j = T_c = 85^\circ\text{C}$.
2. Color spectra shown is 2700K and 90CRI.
3. Color spectra shown is 3000K and 90 CRI.
4. Color spectra shown is 3500K and 90 CRI.
5. Color spectra shown is 4000K and 90 CRI.

Mechanical Dimensions

Figure 10: Drawing for V22 LED Array

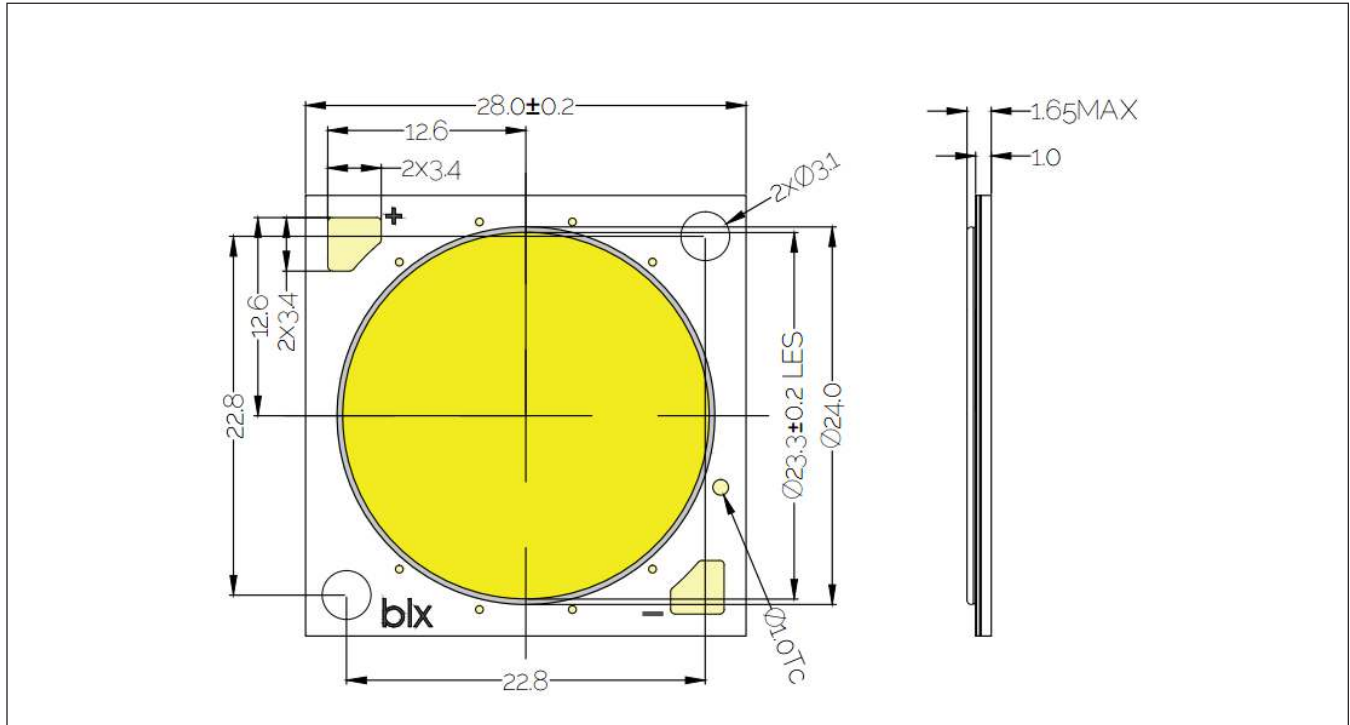

Notes for Figure 10:

1. Drawings are not to scale.
2. Drawing dimensions are in millimeters.
3. Unless otherwise specified, tolerances are ±0.1mm.
4. Solder pad labeled "+" denotes positive contact.
5. Refer to Application Notes AN101 for product handling, mounting and heat sink recommendations.
6. The optical center of the LED Array is nominally defined by the mechanical center of the array to a tolerance of ± 0.2mm.
7. Bridgelux maintains a flatness of 0.10mm across the mounting surface of the array.

Color Binning Information

Figure 11: Warm and Neutral White Test Bins in xy Color Space

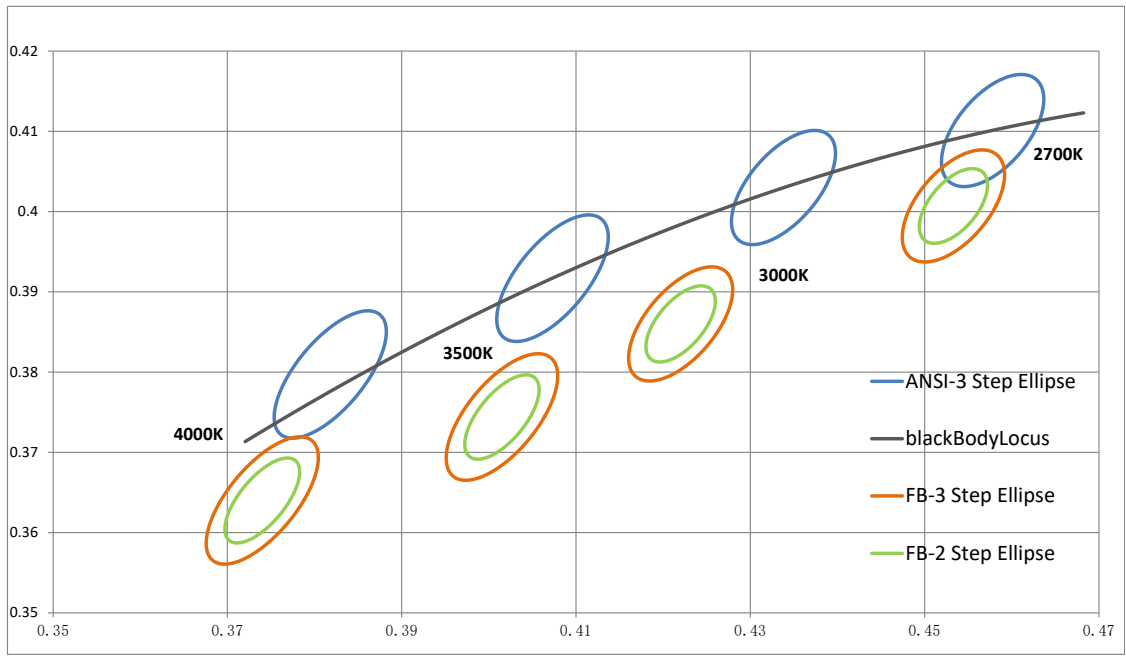

Note: Pulsed Test Conditions, $T_c = 85^\circ\text{C}$

Table 8: Warm and Neutral White xy Bin Coordinates and Associated Typical CCT (product is hot targeted to $T_c = 85^\circ\text{C}$)

Bin Code	2700K	3000K	3500K	4000K
ANSI Bin (for reference only)	(2580K - 2870K)	(2870K - 3220K)	(3220K - 3710K)	(3710K - 4260K)
83 (3 SDCM)	(2645K - 2788K)	(3025K - 3210K)	(3333K - 3567K)	(3935K - 4254K)
82 (2 SDCM)	(2668K - 2764K)	(3055K - 3178K)	(3370K - 3526K)	(3985K - 4197K)
Center Point (x,y)	(0.4533, 0.4007)	(0.422, 0.386)	(0.4015, 0.3744)	(0.374, 0.364)

Note for Tables 8:

1. Bridgelux maintains a tolerance of +/- 0.007 on x and y color coordinates in the CIE 1931 color Space.

Packaging and Labeling

Figure 12: Drawing for V22 Packaging Tube

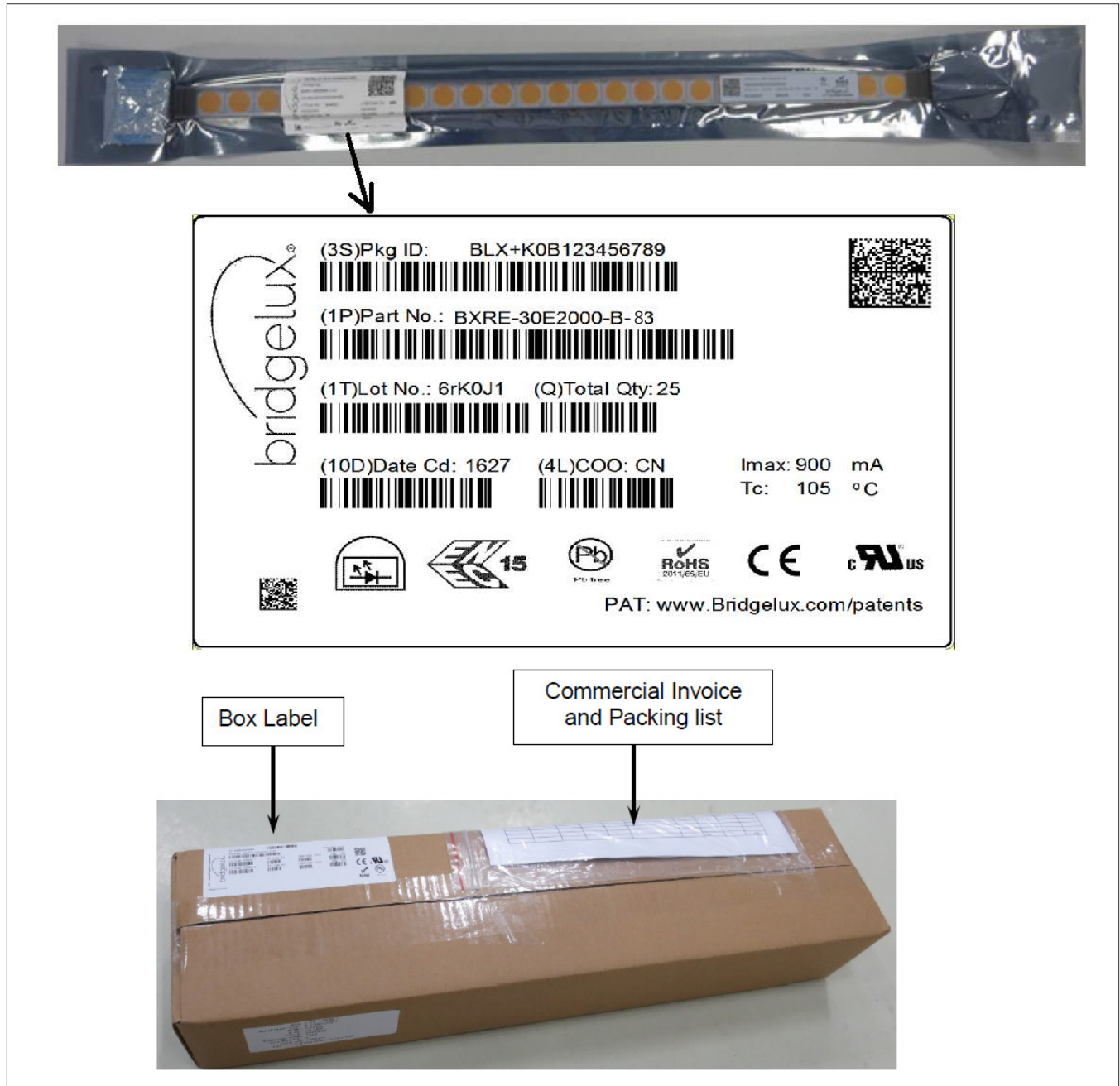

Notes for Figure 12:

1. Each tube holds 15 V22 COB arrays.
2. Four tubes are sealed in an anti-static bag. Four bags are placed in a shipping box and shipped. Depending on quantities ordered, a bigger shipping box, containing four boxes may be used to ship products.
3. Each bag and box is to be labeled as shown above.
4. Dimensions for each tube are 30.7 (W) x 9.65(H) x 460(L). Dimensions for the anti-static bag are 120mm (W) x 635mm (L) x 0.1 (T) mm. Dimensions for the shipping box are 58.7 x 13.3 x 7.9 cm.

Packaging and Labeling

Figure 13: Gen. 8 Product Labeling

Bridgelux COB arrays have laser markings on the back side of the substrate to help with product identification. In addition to the product identification markings, Bridgelux COB arrays also contain markings for internal Bridgelux manufacturing use only. The image below shows which markings are for customer use and which ones are for Bridgelux internal use only. The Bridgelux internal manufacturing markings are subject to change without notice, however these will not impact the form, function or performance of the COB array.

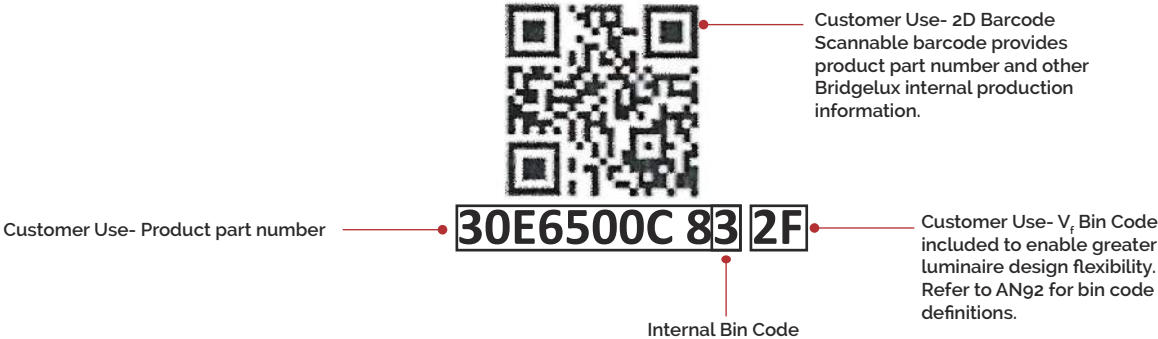

Design Resources

Application Notes

Bridgelux has developed a comprehensive set of application notes and design resources to assist customers in successfully designing with the V Series product family of LED array products. For all available application notes visit www.bridgelux.com.

Optical Source Models

Optical source models and ray set files are available for all Bridgelux products. For a list of available formats, visit www.bridgelux.com.

3D CAD Models

Three dimensional CAD models depicting the product outline of all Bridgelux V Series LED arrays are available in both IGS and STEP formats. Please contact your Bridgelux sales representative for assistance.

LM80

LM80 testing has been completed and the LM80 report is now available. Please contact your Bridgelux sales representative for LM-80 report.

Precautions

CAUTION: CHEMICAL EXPOSURE HAZARD

Exposure to some chemicals commonly used in luminaire manufacturing and assembly can cause damage to the LED array. Please consult Bridgelux Application Note AN101 for additional information.

CAUTION: RISK OF BURN

Do not touch the V Series LED array during operation. Allow the array to cool for a sufficient period of time before handling. The V Series LED array may reach elevated temperatures such that could burn skin when touched.

CAUTION

CONTACT WITH LIGHT EMITTING SURFACE (LES)

Avoid any contact with the LES. Do not touch the LES of the LED array or apply stress to the LES (yellow phosphor resin area). Contact may cause damage to the LED array.

Optics and reflectors must not be mounted in contact with the LES (yellow phosphor resin area).

Disclaimers

MINOR PRODUCT CHANGE POLICY

The rigorous qualification testing on products offered by Bridgelux provides performance assurance. Slight cosmetic changes that do not affect form, fit, or function may occur as Bridgelux continues product optimization.

STANDARD TEST CONDITIONS

Unless otherwise stated, array testing is performed at the nominal drive current.

About Bridgelux: Bridging Light and Life™

At Bridgelux, we help companies, industries and people experience the power and possibility of light. Since 2002, we've designed LED solutions that are high performing, energy efficient, cost effective and easy to integrate. Our focus is on light's impact on human behavior, delivering products that create better environments, experiences and returns—both experiential and financial. And our patented technology drives new platforms for commercial and industrial luminaires.

For more information about the company, please visit
bridgelux.com
twitter.com/Bridgelux
facebook.com/Bridgelux
youtube.com/user/Bridgelux
linkedin.com/company/bridgelux-inc-_2
WeChat ID: BridgeluxInChina



46410 Fremont Boulevard
Fremont, CA 94538 U.S.A.
Tel (925) 583-8400
www.bridgelux.com

© 2022 Bridgelux, Inc. All rights reserved. Product specifications are subject to change without notice. Bridgelux, the Bridgelux stylized logo design and Vero are registered trademarks. V Series and Decor Series are trademarks of Bridgelux, Inc. All other trademarks are the property of their respective owners.

Bridgelux V22 F90 BBBL Array Series Product Data Sheet DS449-1 Rev. A (08/2022)