

AZEV200

40 AMP 2 POLES POWER RELAY WITH MONITORING

FEATURES

- Designed for IEC 61851 Mode 2 and Mode 3 charging applications
- Dual NO load contacts plus NC mirror contact acc. EN 60947-4-1 for welding monitoring
- 40 Amp / 480 VAC switching capability
- Meets IEC 62955, IEC 62752 and IEC 62052-11 short circuit requirements
- Load contact gap ≥ 3.42 mm
- Dielectric strength 5 kV_{RMS}, surge withstand voltage 10 kV
- TÜV, UL / CUR and CQC approvals



CONTACTS

Arrangement load contacts monitor contact	2PST-NO (2 Form A) SPST-NC (1 Form B) coupled to load contacts
Ratings (max.) load contacts switched power switched current continuous current switched voltage contact load category monitor contact switched current minimum load	(resistive load) 19200 VA 40 A 40 A 480 VAC CC2 100 mA at 12 VDC 10 mA, 5 VDC, 50 mW (gold plated contact)
Approved ratings load contacts monitor contact	(TÜV, UL/CUR, CQC) 40 A at 480 VAC, resistive, 85°C, 6k cycles 35 A at 400 VAC, resistive, 85°C, 50k cycles 32 A at 400 VAC, resistive, 95°C, 50k cycles 10 A make, 40 A carry, 10 A break at 480 VAC, 85°C, resistive, 50k cycles 10 mA at 12 VDC, 85°C, 50k cycles
Contact material load contacts monitor contact	AgSnO ₂ (silver tin oxide) AgNi + Au (silver nickel, gold plated)
Contact gap load contacts monitor contact	(clearance of open contacts) ≥ 3.42 mm ≥ 0.7 mm (≥ 0.5 mm if load contacts are welded)
Contact resistance load contacts monitor contact	≤ 10 m Ω initial max. (20 A) < 2 m Ω typ. (32 A) ≤ 100 m Ω

COIL

Nominal coil voltages	6, 9, 12, 24, 48 (DC)
Dropout voltage	$> 5\%$ of nominal coil voltage
Holding voltage	35 - 80% of nominal coil voltage (@23°C) 40 - 65% of nominal coil voltage (@85°C)
Power nominal holding power	(at 23°C) 2.6 W 420 mW
Release energy	< 7 mJ
Thermal resistance	35 K/W (typ. at 40 - 80% nom. coil voltage)
Temperature rise	70 K (126°F)
Insulation system	class F, max. temperature 155°C (311°F)

GENERAL DATA

Life Expectancy mechanical electrical	(minimum operations) 1×10^5 see rated loads
Operate Time	≤ 30 ms (at nominal coil voltage)
Release Time	≤ 10 ms (at nominal coil voltage, without coil suppression)
Dielectric Strength open load contacts between load contact sets coil to load contacts load to monitor contacts open monitor contacts coil to monitor contacts	(at sea level for 1 min.) 2 kV _{RMS} 2 kV _{RMS} 5 kV _{RMS} 5 kV _{RMS} 1 kV _{RMS} 1 kV _{RMS}
Surge Voltage open load contacts coil to load contacts load to monitor contacts	(1.2/50 μ s pulses) 6 kV 10 kV 8 kV
Insulation Distances load contact sets coil to load contacts load to monitor contacts coil to monitor contact	(clearance / creepage) ≥ 5.5 mm / ≥ 8.0 mm ≥ 5.5 mm / ≥ 8.0 mm ≥ 5.5 mm / ≥ 8.0 mm ≥ 2.0 mm / ≥ 5.0 mm
Insulation Resistance	≥ 1000 M Ω (23°C, 500 VDC, 50% rh)
Short circuit capacity referring to IEC 62955 referring to IEC 62752 referring to IEC 62052-11	$I_p = 1.85$ kA; $I^2t = 4.5$ kA ² s $I_p = 1.50$ kA; $I^2t = 6.0$ kA ² s $I_p = 1.36$ kA; $I^2t = 9.25$ kA ² s
Temperature Range operating	(at coil holding voltage) -40°C (-40°F) to 95°C (185°F)
Vibration resistance	0.062" (1.5 mm) DA at 10–55 Hz
Shock	10 g
Enclosure protection category material group flammability	PBT polyester RT II, flux proof IIIa UL94 V-0
Terminals	Tinned copper alloy, THT PCB mounting
Soldering preheating soldering	(referring IEC 61760-1 wave soldering) 120°C (248°F) / ≤ 120 s 260 ± 5 °C (500 ± 9 °F) / $\leq 2 \times 5$ s
Dimensions (L/W/H)	36.5 mm / 33.8 mm / 41.5 mm
Weight	85 grams (approx.)
Compliance	UL 508, IEC 61810-1, GB/T 21711.1-2008, RoHS, REACH
Agency Approvals TÜV UL / CUR CQC	B 088793 0020 E365652 CQC22002356459
Packing (pcs.)	10 per plastic tube 150 per carton box

ZETTLER

AZEV200

COIL VOLTAGE SPECIFICATIONS

Voltage [VDC]				Resistance [Ω] $\pm 10\%$	Inductance (ref.) [mH]		Current (ref.) [mA]		Power (ref.) [W]	
nominal	must operate	min. holding	max.		de-energized	excited	nominal	min. holding	nominal	min. holding
6	4.5	2.4	6.6	13.9	130	165	432	173	2.6	0.42
9	6.7	3.6	9.9	31.2	290	370	288	116		
12	9.0	4.8	13.2	55.4	520	660	216	87		
24	18.0	9.6	26.4	221.5	2050	2640	108	44		
48	36.0	19.2	52.8	886.2	8200	10560	54	22		

- Notes: 1. All values at 23°C, upright position, terminals downward.
 2. Voltage max. is the voltage the coil can endure for a short period of time.
 3. Values for coil inductance, coil current and coil power for reference only.
 4. To avoid overheating at elevated ambient temperatures, operate the coil at 40 - 65% of nominal coil voltage after applying the full nominal coil voltage for ≥ 200 milliseconds.

ORDERING DATA

AZEV200-2AE - D

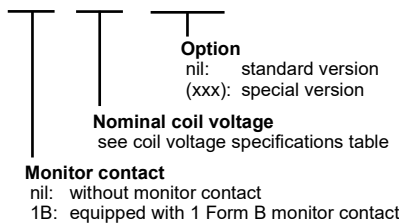

Example ordering data

AZEV200-2AE1B-12D 1 Form B monitor contact, 12 VDC coil voltage

AZEV200-2AE-24D version without monitor contact, 24 VDC coil

AZEV200-2AE1B-12D(001) special version with non gold plated 1 Form B monitor contact.

TIMING DIAGRAM

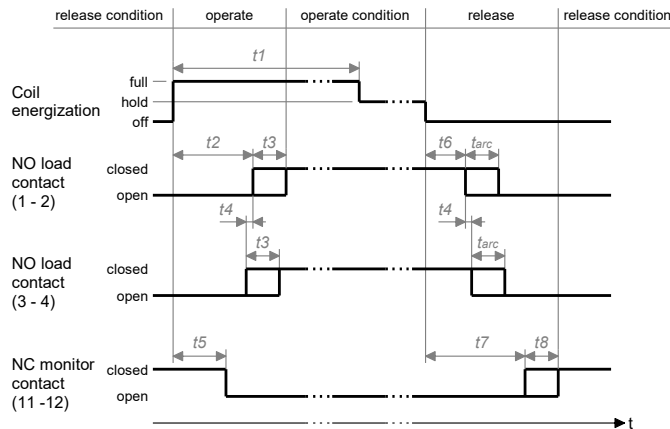

Item	Description	Notes	Timing [ms]		
			min.	typ.	max.
t_1	Full energization time	recommended value for reference	200	-	-
t_2	NO operate time	at nominal coil voltage	-	18	30
t_3	NO bounce time	at nominal coil voltage	-	3.5	-
t_4	NO sync time	at nominal coil voltage	-	± 0.1	-
t_5	NC operate time	at nominal coil voltage	-	10	-
t_6	NO release time	without coil suppression	-	-	10
		with suppression: $U_{BR}/U_{nom} = 2$	-	3.5	-
t_7	NC release time	with suppression: $U_{BR}/U_{nom} = 2$	-	5.7	-
t_8	NC bounce time		-	10.5	-
t_{arc}	arcing duration	if released under load, dependent on actual load			

- Notes: 1. U_{nom} is the specified nominal coil voltage.
 2. U_{BR} is the coil suppression circuit breakdown voltage.

MECHANICAL DATA

Dimensions in mm. Tolerance: ± 0.3 mm.
 Pin dimensions for reference only and given without tin coating.

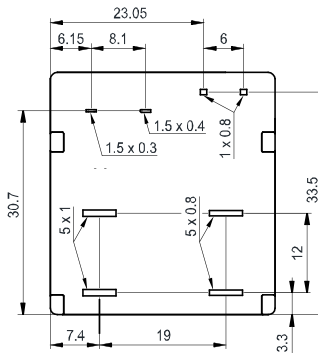
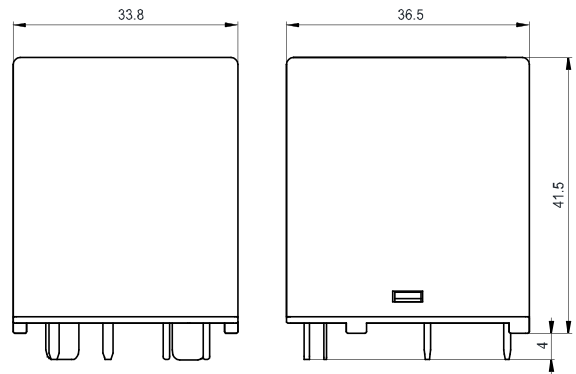

CAD data in attachment of the datasheet.

PCB FOOTPRINT / WIRING DIAGRAM

Layout and footprint recommendation. Dimensions in mm.
 Viewed towards terminals.

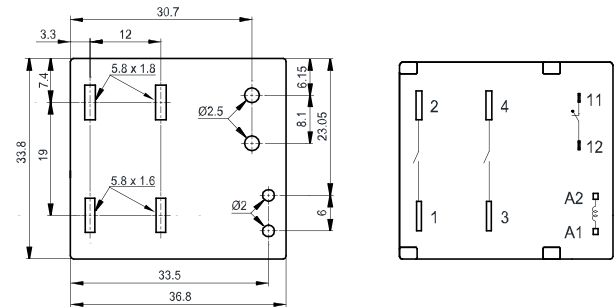

AZEV200

CHARACTERISTICS

Operate timing vs. coil energization @23°C (typ.)

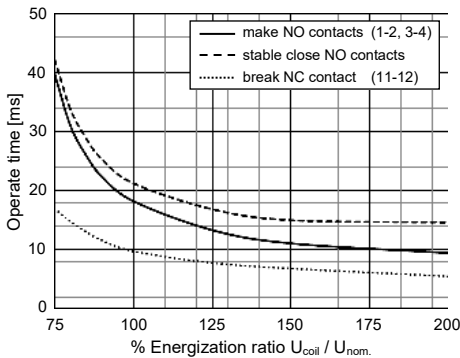

Release time vs. suppressor breakdown voltage (typ.)

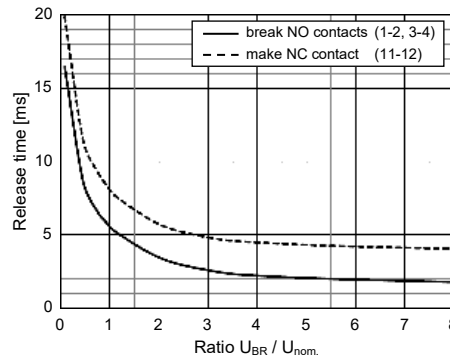

Coil temperature rise vs. energization @23°C (typ.)

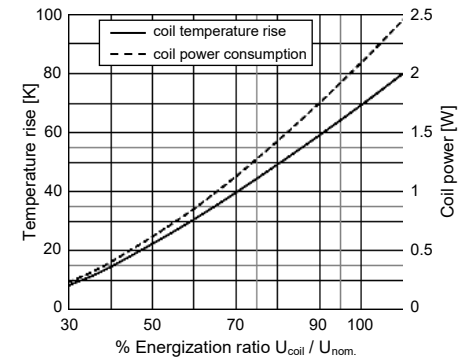

NOTES

General

1. All values in this datasheet are at reference temperature of 23°C (73°F) unless stated otherwise.
2. Evaluate the component's performance and operating conditions under the worst-case conditions of the actual application.
3. The datasheet and the component's specifications are subject to change without notice.

Storage, handling, and environmental guidelines

4. Relays are electromechanical components that are sensitive to shock. The relay's adjustment can be affected if the relay is subjected to excessive shock or excessive pressure is applied to the relay case. Relays which have been dropped must no longer be used.
5. Substances containing silicone or phosphorus must be avoided in the vicinity to the relay. Outgassing from these substances can penetrate the relay and adhere on the contacts. Deposits of these substances may act as insulators and adversely affect the contact resistance. Silicone can be found e.g. in gaskets, lubricants or filling materials, phosphorus can be found e.g. as a flame retardant in plastics.
6. Prevent relays from atmospheres containing corrosive gases. Corrosion of internal structures and contacts leads to malfunction and shortens the component's service life.
7. Prevent non-sealed relays from atmospheres subject to dust. Dust particles may enter the case and get stuck between the contacts, causing the contact circuits to fail.
8. Do not use these relays in environments with explosive or flammable gases. Electrical arcing at the contacts could ignite these gases and cause fire.
9. For automated dual wave soldering process we recommend preheating with 120°C (248°F) for max. 120 seconds and a soldering temperature of 260 ±5°C (500 ±9°F) for max. 10 seconds soldering time (max. 5 seconds per wave). For manual soldering we recommend 350°C (662°F) max. temperature for max. 5 seconds. During the soldering process, no force may be exerted on the relay terminals.
10. This relay is designed according to RTII relay technology (flux-proof). It must not be washed, immersion cleaned or conformal coated as substances may enter the case and cause corrosion or seizure of mechanical parts.
11. Avoid high frequency or ultrasonic vibrations on the relays as these can cause contact welding and misalignment or destruction of internal structures.
12. During operation, storage and transport, ambient temperature should be within the specified operating temperature range. Humidity should be in the range of 5% to 85% RH. Icing and condensation must be avoided. Relays stored for an extended period of time may show initially increased contact resistance values due to chemical effects such as oxidation.

Design guidelines

13. The relay may pull in and operate with less than the specified *must operate* voltage value.
14. The coil's *must operate* and *min. holding* voltages and the coil's *resistance* value depend on the temperature of the coil. The specified values are given for a coil temperature of 23°C and increase by approx. 0.39% per Kelvin of temperature rise. This circumstance must be considered, especially during operation with high load currents and elevated ambient temperature.
15. Coil suppression circuits such as diodes, etc. in parallel to the coil will lengthen the release time. We recommend using suppression circuits with a breakdown voltage of approx. 2 times the nominal coil voltage in order to achieve a quick release time.
16. At elevated ambient temperatures, after applying the rated nominal coil voltage for ≥ 200 milliseconds, the coil energization must be reduced to a holding level in order to reduce thermal stress and prevent the coil from overheating.
17. For PWM coil control use a fast-switching bypass diode in parallel with the coil to allow the coil current to flow during pulse pauses. Note that this bypass diode increases the release time of the relay. We recommend ≥ 20 kHz as a PWM frequency in order to avoid audible noise from magnetostriction.
18. Contact resistance is a function of load current, dwell time and wear level of the contacts. Immediately after closing the contacts, or if tested with low current only, the contact resistance will show a relatively high value. A low level steady state contact resistance is reached at higher current after a certain time in thermal equilibrium.
19. The relay dissipates heat from power losses through its load terminals. Provide sufficient cross section and area of the PCB traces so that they can act as heat spreader.
20. For PCBs with multiple relays, do not place the components directly next to each other. We suggest providing a mounting distance of minimum 10 mm to allow for better cooling.
21. A minimum load of 10 mA / 5 V / 50 mW is recommended for gold plated contacts to ensure a reliable and stable connection.

ZETTLER

AZEV200

DISCLAIMER

This product specification is to be used in conjunction with the application notes which can be downloaded from the regional ZETTLER relay websites. The specification provides an overview of the most significant part features. Any individual applications and operating conditions are not taken into consideration. It is recommended to test the product under application conditions. Responsibility for the application remains with the customer. Proper operation and service life cannot be guaranteed if the part is operated outside the specified limits.

ZETTLER GROUP

Building on a foundation of more than a century of expertise in German precision engineering, ZETTLER Group is a world-class enterprise, engaged in the design, manufacturing, sales and distribution of electronic components. Our industry leadership is based on a unique combination of engineering competence and global scale.

For more information on other ZETTLER Group companies, please visit zettler-group.com. For support on this product or other ZETTLER relays, please visit one of the group sites below.

SITES FOR ZETTLER RELAYS

NORTH AMERICA

American Zettler, Inc.
www.azettler.com
sales@azettler.com

EUROPE

Zettler Electronics, GmbH
www.zettlerelectronics.com
office@zettlerelectronics.com

Zettler Electronics, Poland
www.zettlerelectronics.pl
office@zettlerelectronics.pl

CHINA

Zettler Group, China
www.zettlercn.com
relay@zettlercn.com

ASIA PACIFIC

Zettler Electronics (HK) Ltd.
www.zettlerhk.com
sales@zettlerhk.com



ZETTLER