

REVISIONS				
REV.	ECO. NO	DESCRIPTION	DATE	BY
B	2654	ADD TAIL LENGTH TOL, CONTACT GAP, UPDATE DWG FORMAT	8/14/2012	JH
C	4221	ADD REF ROW SPACING DIM	5/29/2020	JH
D	4562	UPDATE NOTE 8 (REMOVE 'PER CONTACT')	9/27/2022	MM

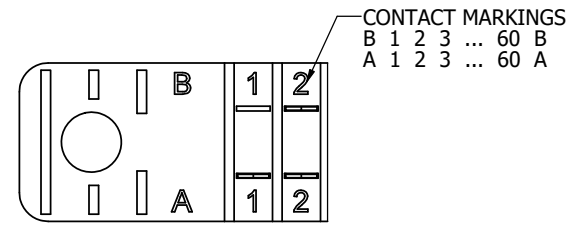

**CONTACT ID  
SCALE 5:1**

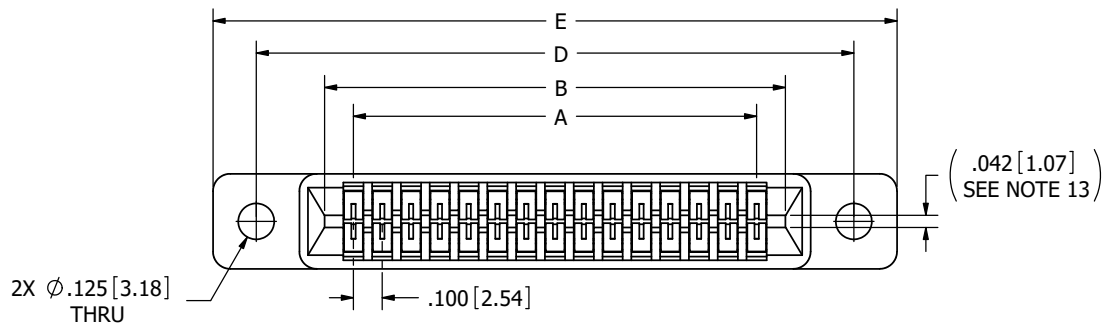
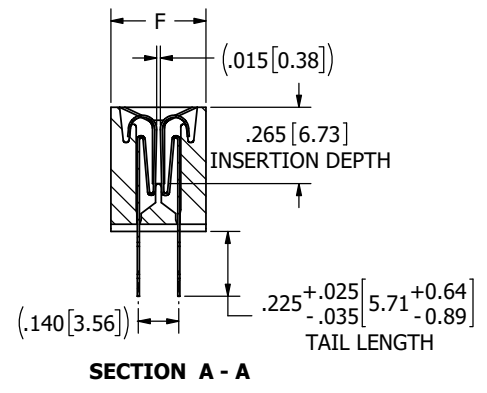
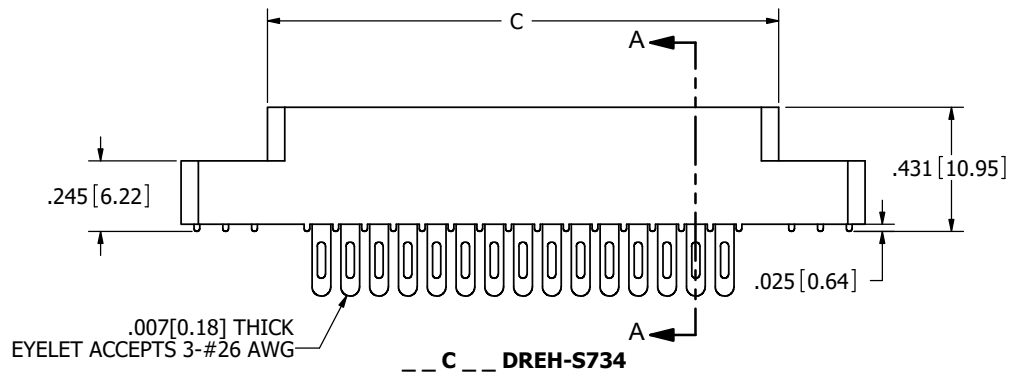

- NOTES:**
- INSULATOR MATERIAL: SEE PART NUMBER CODING
  - CONTACT MATERIAL: SEE PART NUMBER CODING
  - PLATING: SEE PART NUMBER CODING
  - OPERATING TEMPERATURE: SEE PART NUMBER CODING
  - PROCESSING TEMP: SEE PART NUMBER CODING
  - UL FLAMMABILITY RATING: 94V-0
  - OPERATING VOLTAGE: 700 VAC
  - CURRENT RATING: 3 AMP
  - CONTACT RESISTANCE: 30 MILLI OHMS MAX
  - INSULATION RESISTANCE: 5000 MEGA OHMS
  - DURABILITY: 500 CYCLES MINIMUM
  - CONNECTOR IDENTIFICATION: THE PART SHALL BE MARKED WITH A PART NUMBER AND LOT CODE
  - BOARD THICKNESS ACCOMMODATED: .031 ± .005 [0.79 ± 0.12]
  - INSERTION FORCE: 16 OZ MAX PER CONTACT PAIR WHEN USING A .031 [0.79] TEST BLADE  
INTERNAL INSPECTION TO BE PER SULLINS WORK INSTRUCTION WI-8.6-03
  - WITHDRAWAL FORCE: 1 OZ MIN PER CONTACT PAIR USING .031 [0.79] TEST BLADE
  - MODIFICATION: FOR .031" DAUGHTER CARD



**CUSTOMER COPY**

UNLESS OTHERWISE SPECIFIED: DIMENSIONS ARE IN INCHES (MM)		DRAWN	DATE	NAME	
TOLERANCES: ANGULAR: ± 1° DECIMALS .XX = ± .02 [5] .XXX = ± .005 [13] .XXXX = ± .0005 [013]		JH	8/14/2012	JH	
<small>THE INFORMATION HEREIN CONTAINS PROPRIETARY INFORMATION OF SULLINS ELECTRONICS AND IS NOT TO BE REPRODUCED, USED OR DISCLOSED TO OTHERS FOR ANY PURPOSE EXCEPT AS SPECIFICALLY AUTHORIZED IN WRITING BY AN OFFICER OF SULLINS ELECTRONICS.</small>					<b>TITLE</b> EDGE CARD, .100 CC LP <b>PART NUMBER</b> C DRE -S734
SIZE	CAGE CODE	DWG. NO.	REV	<b>SCALE:</b> 3:1 <b>SHEET:</b> 1 OF 3	
C	54453	C10884	D		

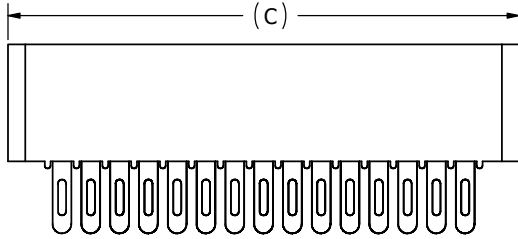
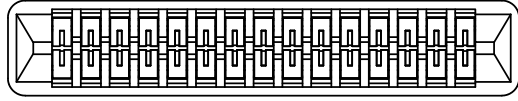

--- C --- DREN-S734

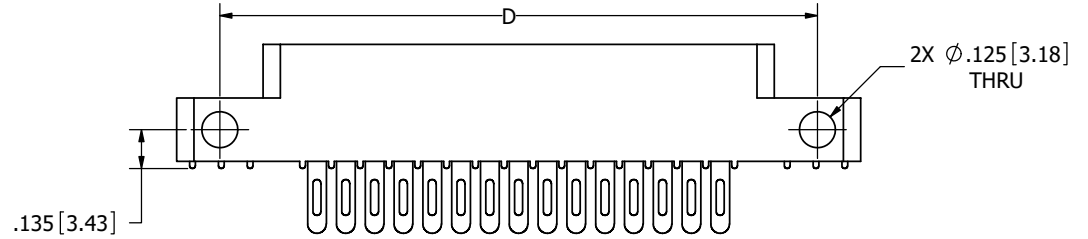
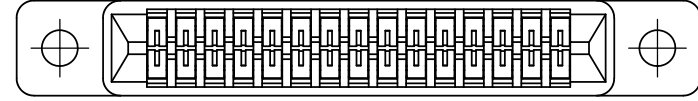

--- C --- DRES-S734

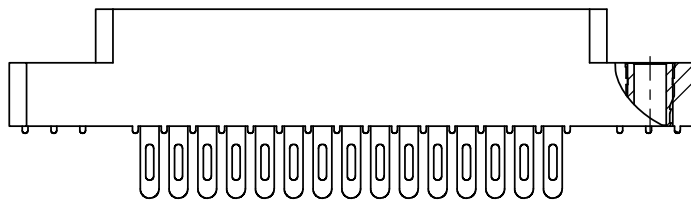
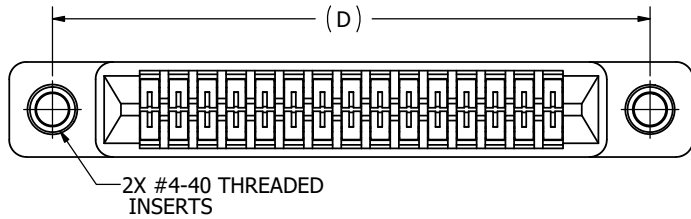

--- C --- DREI-S734

2X FLOATING BOBBIN  
 Ø.116 [2.95]  
 CLEARANCE FOR # 4 SCREW

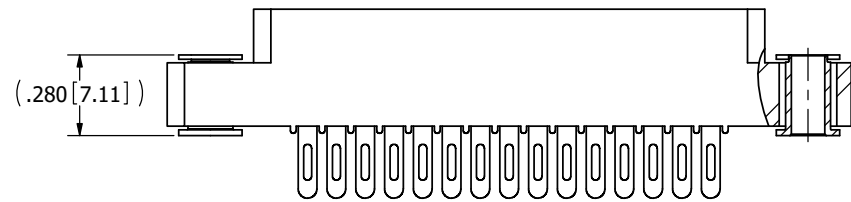
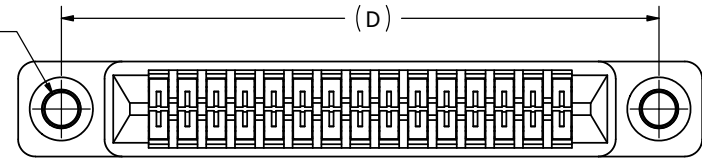

--- C --- DREF-S734

# CUSTOMER COPY



RoHS COMPLIANT

UNLESS OTHERWISE SPECIFIED:  
 DIMENSIONS ARE IN INCHES (MM)

TOLERANCES:  
 ANGULAR: ± 1°

DECIMALS  
 .XX= ± .02 [5]  
 .XXX= ± .005 [13]  
 .XXXX= ± .0005 [13]

DRAWN	DATE	NAME
JH	8/14/2012	JH

THE INFORMATION HEREIN CONTAINS PROPRIETARY INFORMATION OF SULLINS ELECTRONICS AND IS NOT TO BE REPRODUCED, USED OR DISCLOSED TO OTHERS FOR ANY PURPOSE EXCEPT AS SPECIFICALLY AUTHORIZED IN WRITING BY AN OFFICER OF SULLINS ELECTRONICS.

<b>SULLINS</b> CONNECTOR SOLUTIONS			
TITLE EDGE CARD, .100 CC LP			
PART NUMBER --- C --- DRE --- S734			
SIZE	CAGE CODE	DWG. NO.	REV
C	54453	C10884	D
SCALE: 3:1			SHEET 2 OF 3

PART NUMBER	NO. OF POS.	A±.008[0.20]		B±.008[0.20]		C±.015[0.38]		D±.010[0.25]		E±.020[0.51]		F+.005/-0.015[+0.13/-0.38]	
		IN	MM	IN	MM	IN	MM	IN	MM	IN	MM	IN	MM
C04DRE -S734	4	0.300	7.62	0.500	12.70	0.675	17.15	0.975	24.77	1.275	32.39	0.330	8.38
C05DRE -S734	5	0.400	10.16	0.600	15.24	0.775	19.69	1.075	27.31	1.375	34.93		
C06DRE -S734	6	0.500	12.70	0.700	17.78	0.875	22.23	1.175	29.85	1.475	37.47		
C07DRE -S734	7	0.600	15.24	0.800	20.32	0.975	24.77	1.275	32.39	1.575	40.01		
C08DRE -S734	8	0.700	17.78	0.900	22.86	1.075	27.31	1.375	34.93	1.675	42.55		
C10DRE -S734	10	0.900	22.86	1.100	27.94	1.275	32.39	1.575	40.01	1.875	47.63		
C12DRE -S734	12	1.100	27.94	1.300	33.02	1.475	37.47	1.775	45.09	2.075	52.71		
C13DRE -S734	13	1.200	30.48	1.400	35.56	1.575	40.01	1.875	47.63	2.175	55.25		
C15DRE -S734	15	1.400	35.56	1.600	40.64	1.775	45.09	2.075	52.71	2.375	60.33		
C17DRE -S734	17	1.600	40.64	1.800	45.72	1.975	50.17	2.275	57.79	2.575	65.41		
C18DRE -S734	18	1.700	43.18	1.900	48.26	2.075	52.71	2.375	60.33	2.675	67.95		
C19DRE -S734	19	1.800	45.72	2.000	50.80	2.175	55.25	2.475	62.87	2.775	70.49		
C20DRE -S734	20	1.900	48.26	2.100	53.34	2.275	57.79	2.575	65.41	2.875	73.03		
C22DRE -S734	22	2.100	53.34	2.300	58.42	2.475	62.87	2.775	70.49	3.075	78.11		
C23DRE -S734	23	2.200	55.88	2.400	60.96	2.575	65.41	2.875	73.03	3.175	80.65		
C25DRE -S734	25	2.400	60.96	2.600	66.04	2.775	70.49	3.075	78.11	3.375	85.73		
C26DRE -S734	26	2.500	63.50	2.700	68.58	2.875	73.03	3.175	80.65	3.475	88.27		
C28DRE -S734	28	2.700	68.58	2.900	73.66	3.075	78.11	3.375	85.73	3.675	93.35		
C30DRE -S734	30	2.900	73.66	3.100	78.74	3.275	83.19	3.575	90.81	3.875	98.43		
C31DRE -S734	31	3.000	76.20	3.200	81.28	3.375	85.73	3.675	93.35	3.975	100.97		
C35DRE -S734	35	3.400	86.36	3.600	91.44	3.775	95.89	4.075	103.51	4.375	111.13		
C36DRE -S734	36	3.500	88.90	3.700	93.98	3.875	98.43	4.175	106.05	4.475	113.67		
C40DRE -S734	40	3.900	99.06	4.100	104.14	4.275	108.59	4.575	116.21	4.875	123.83		
C43DRE -S734	43	4.200	106.68	4.400	111.76	4.575	116.21	4.875	123.83	5.175	131.45		
C44DRE -S734	44	4.300	109.22	4.500	114.30	4.675	118.75	4.975	126.37	5.275	133.99		
C49DRE -S734	49	4.800	121.92	5.000	127.00	5.175	131.45	5.475	139.07	5.775	146.69		
C50DRE -S734	50	4.900	124.46	5.100	129.54	5.275	133.99	5.575	141.61	5.875	149.23		
C52DRE -S734	52	5.100	129.54	5.300	134.62	5.475	139.07	5.775	146.69	6.075	154.31		
C60DRE -S734	60	5.900	149.86	6.100	154.94	6.275	159.39	6.575	167.01	6.875	174.63		
C65DRE -S734	65	6.400	162.56	6.600	167.64	6.775	172.09	7.075	179.71	7.375	187.33		

**PART NUMBER CODING**

**C DRE -S734**

**MATERIAL (INSULATOR/CONTACT)**  
**E= BLUE PBT/PHOSPHOR BRONZE**  
 OPERATING TEMP: -65°C TO +125°C  
 PROCESSING TEMP: WAVE/MANUAL SOLDERING  
**R= GREEN PPS/PHOSPHOR BRONZE**  
 OPERATING TEMP: -65°C TO +125°C  
 PROCESSING TEMP: 260°C MAX FOR 20 SECS  
**G= BLACK PA9T/PHOSPHOR BRONZE**  
 OPERATING TEMP: -65°C TO +125°C  
 PROCESSING TEMP: 260°C MAX FOR 20 SECS  
**H= BLUE PBT/BERYLLIUM COPPER**  
 OPERATING TEMP: -65°C TO +125°C  
 PROCESSING TEMP: WAVE/MANUAL SOLDERING  
**A= GREEN PPS/BERYLLIUM COPPER**  
 OPERATING TEMP: -65°C TO +150°C  
 PROCESSING TEMP: 260°C MAX FOR 20 SECS  
**J= BLACK PA9T/BERYLLIUM COPPER**  
 OPERATING TEMP: -65°C TO +150°C  
 PROCESSING TEMP: 260°C MAX FOR 20 SECS  
**C= GREEN PPS/BERYLLIUM NICKEL (CONSULT FACTORY)**  
 OPERATING TEMP: -65°C TO +200°C  
 PROCESSING TEMP: 260°C MAX FOR 20 SECS  
**F= GREEN PPS/SPINODAL (CONSULT FACTORY)**  
 OPERATING TEMP: -65°C TO +200°C  
 PROCESSING TEMP: 260°C MAX FOR 20 SECS  
 AVAILABLE IN OVERALL GOLD ONLY (S OR M PLATING)  
**W= TAN PEEK/BERYLLIUM NICKEL (CONSULT FACTORY)**  
 OPERATING TEMP: -65°C TO +250°C  
 PROCESSING TEMP: 260°C MAX FOR 20 SECS  
 AVAILABLE IN OVERALL GOLD ONLY (M PLATING)

**NUMBER OF POSITIONS (CONTACTS PER ROW)**

**PLATING**

ALL PLATINGS HAVE .000050" NICKEL UNDERPLATE  
 CONTACT SURFACE  
 B = .000010" GOLD  
 C = .000030" GOLD  
 G = .000010" GOLD  
 Y = .000030" GOLD  
 \*\*E = .000100" PURE TIN, MATTE  
 S = .000010" GOLD OVERALL  
 M = .000030" GOLD  
 \*\*ONLY AVAILABLE ON MATERIAL CODES E, R AND G

**MOUNTING STYLE**  
 H = .125" DIA. CLEARANCE HOLES (PAGE 1)  
 I = #4-40 THREADED INSERT (PAGE 2)  
 S = .125" DIA. SIDE MOUNTING (PAGE 2)  
 N = NO MOUNTING EARS (PAGE 2)  
 F = FLOATING BOBBIN (PAGE 2)

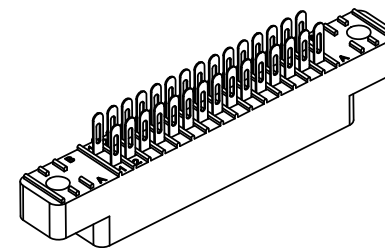

RoHS COMPLIANT

UNLESS OTHERWISE SPECIFIED, DIMENSIONS ARE IN INCHES (MM)		DRAWN	DATE	NAME	
			8/14/2012	JH	
TOLERANCES: ANGULAR: ± 1° DECIMALS .XX = ± .02 [5] .XXX = ± .005 [13] .XXXX = ± .0005 [013]					THE INFORMATION HEREIN CONTAINS PROPRIETARY INFORMATION OF SULLINS ELECTRONICS AND IS NOT TO BE REPRODUCED, USED OR DISCLOSED TO OTHERS FOR ANY PURPOSE EXCEPT AS SPECIFICALLY AUTHORIZED IN WRITING BY AN OFFICER OF SULLINS ELECTRONICS.
TITLE <b>EDGE CARD, .100 CC LP</b>					PART NUMBER <b>C DRE -S734</b>
SIZE	CAGE CODE	DWG. NO.	REV		
C	54453		D		
SCALE: 2:1					SHEET 3 OF 3

**CUSTOMER COPY**