



SPECIFICATIONS

Model	Max Torque	Reverse Torque	Damping Direction	Max Angle
FYN-P1-L183	1.8Nm (18kgfcm)	0.8Nm or lower (8kgfcm or lower)	Counter-clockwise	115°

Operating Temperature	Weight	Body and Cap Material	Rotating Shaft Material	Oil Type	Cap Color
-5 ~ 50°C	10.5±1g	Polybutylene terephthalate (PBT)	Polybutylene terephthalate (PBT)	Silicone Oil	White

DAMPING CHARACTERISTICS

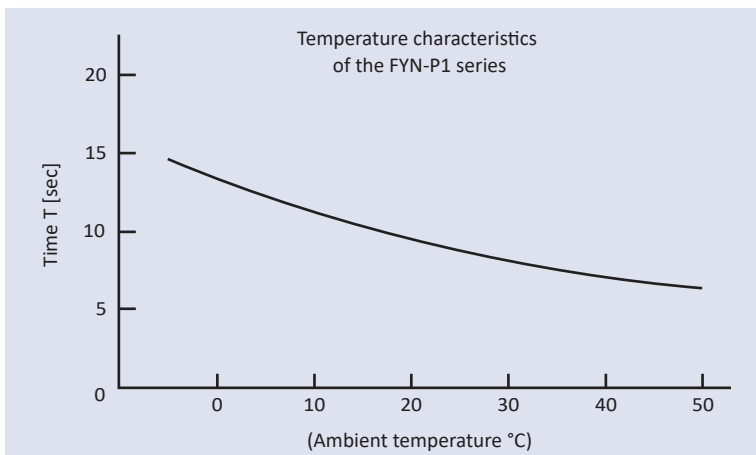

■ Damper characteristics vary according to the ambient temperature. In general, the damper characteristics become weaker as the temperature increases, and become stronger as the temperature decreases. This is because the viscosity of the oil inside the damper varies according to the temperature. When the temperature returns to normal, the damper characteristics will return to normal as well. The changes in the time it takes for the lid to close are shown in the graph to the left.

■ The FYN-P1 Series is designed to generate a large torque just before a lid closing from a vertical position, as shown in Diagram A, comes to a full closure. When a lid is closed from a horizontal position, as shown in Diagram B, a strong torque is generated just before the lid is fully closed, causing the lid to not close properly.

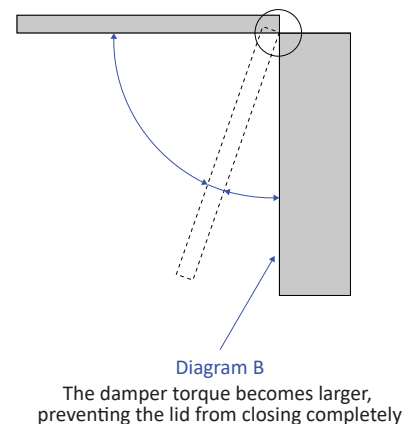
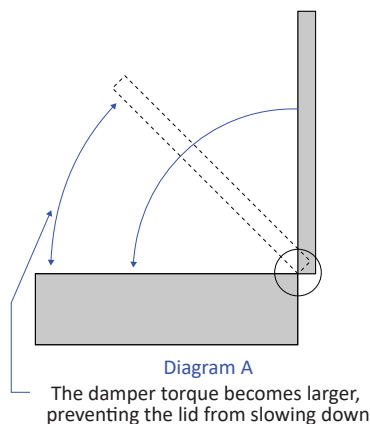

HOW TO USE THE DAMPER

- When using a damper on a lid, such as the one shown in the diagram, use the following selection calculation to determine the damper torque.

Lid mass M : 1kg

Lid dimensions L : 0.3m

Gravity Center Position : Assumed as $\frac{L}{2}$

$$\begin{aligned} \text{Load torque : } T &= 1 \times 9.8 \times 0.3 \div 2 \\ &= 1.47 \text{N} \cdot \text{m} \end{aligned}$$

Based on the above calculation, FYN-P1-*153 is selected

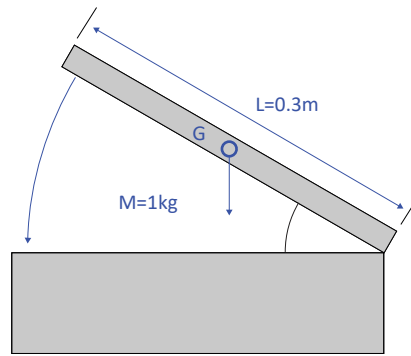

- When connecting the rotating shaft to other parts, please ensure a tight fit between them. Without a tight fit, the lid will not slow down properly when closing. The corresponding dimensions for fixing the rotating shaft and the main body are as follows.

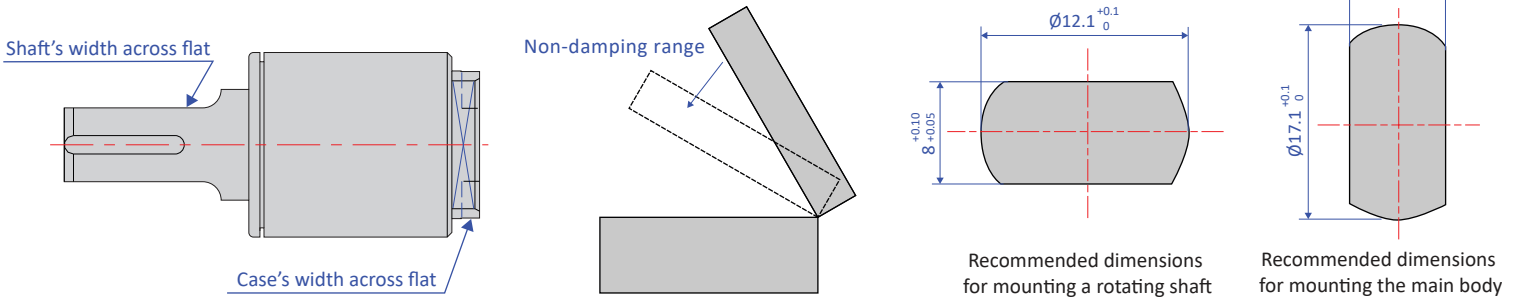

- The damper's working angle is 115° , as shown below. Rotating the damper beyond this angle will cause damage to the damper. Please ensure that an external stopper is in place. The working angle is based on the width across flat for fixing, located towards the rear end of the main body. The position where the rotation is complete is at 90° with respect to the width across flat.

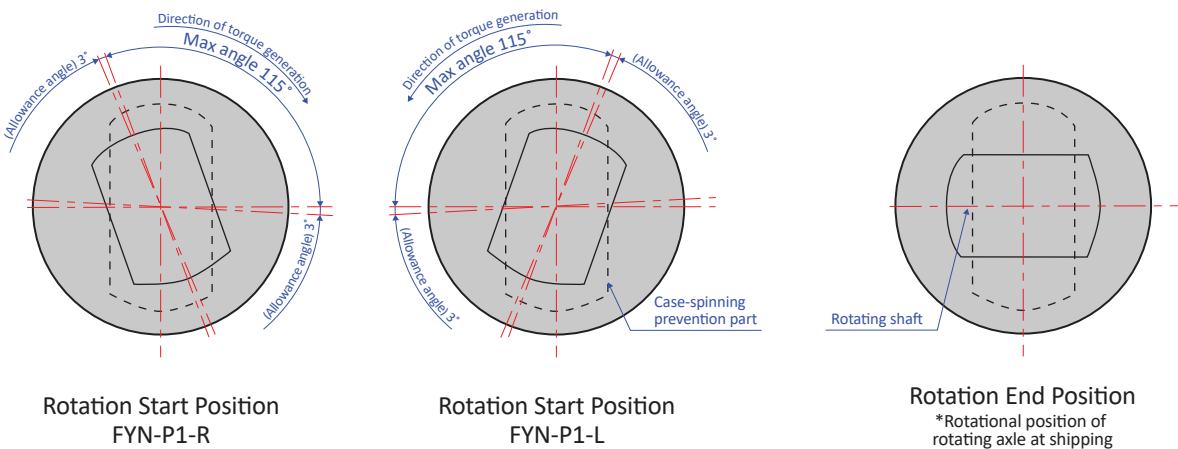

- The direction in which torque is generated varies according to the model. Please select the appropriate model for your purpose.