

CMS80N03H8-HF

**N-Channel
RoHS Device
Halogen Free**

Features

- Advanced high cell density trench technology
- Super low gate charge.
- Excellent Cdv/dt effect decline.
- 100% EAS and Rg guaranteed.
- Green device available.

Mechanical data

- Case: PR-PAK

Circuit Diagram

- G : Gate
- S : Source
- D : Drain

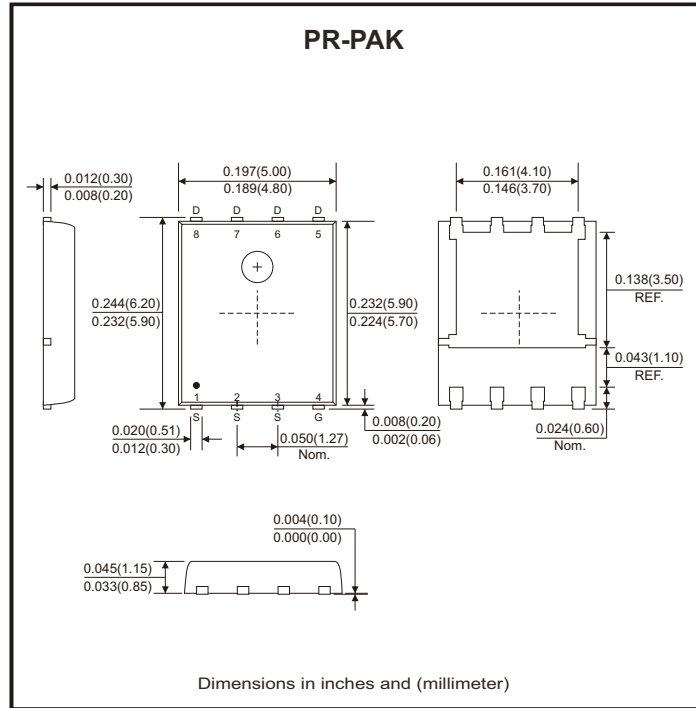
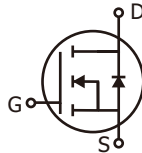

Maximum Ratings

Parameter	Conditions	Symbol	Value	Unit
Drain-source voltage		V_{DS}	30	V
Gate-source voltage		V_{GS}	±20	V
Continuous drain current (Note 1)	$T_C = 25^\circ C$	I_D	80	A
	$T_C = 100^\circ C$	I_D	50	
Pulsed drain current (Note 1, 2)		I_{DM}	160	A
Total power dissipation (Note 4)	$T_C = 25^\circ C$	P_D	53	W
	$T_A = 25^\circ C$	P_D	2	
Single pulse avalanche energy, L=0.1mH (Note 3)		E_{AS}	88	mJ
Single pulse avalanche current, L=0.1mH (Note 3)		I_{AS}	42	A
Operating junction and storage temperature range		T_J, T_{STG}	-55 to +150	°C
Thermal resistance junction-ambient (Note 1)	Steady state	$R_{\theta JA}$	62.5	°C/W
Thermal resistance junction-case (Note 1)	Steady state	$R_{\theta JC}$	2.36	°C/W

- Notes: 1. The data tested by surface mounted on a 1inch² FR-4 board with 2oz copper.
 2. The data tested by pulsed, pulse width ≤ 300μs, duty cycle ≤ 2%.
 3. The EAS data shows max. rating. The test condition is VDD=25V, VGS=10V, L=0.1mH, IAS=42A.
 4. The power dissipation is limited by 150°C junction temperature.

Electrical Characteristics (at T_J=25°C unless otherwise noted)

Parameter	Symbol	Conditions	Min	Typ	Max	Unit
Drain-source breakdown voltage	BV _{DSS}	V _{GS} = 0V, I _D = 250μA	30			V
Gate threshold voltage	V _{GS(th)}	V _{DS} = V _{GS} , I _D = 250μA	1.0		2.5	V
Forward transconductance	g _{fs}	V _{DS} = 10V, I _D = 10A		18		S
Gate-source leakage current	I _{GSS}	V _{GS} = ±20V			±100	nA
Drain-source leakage current (T _J =25°C)	I _{DSS}	V _{DS} = 30V, V _{GS} = 0V			1	μA
Drain-source leakage current (T _J =125°C)		V _{DS} = 24V, V _{GS} = 0V			10	
Static drain-source on-resistance (Note 2)	R _{DS(on)}	V _{GS} = 10V, I _D = 20A			5.5	mΩ
		V _{GS} = 4.5V, I _D = 10A			8	
Total gate charge (Note 2)	Q _g	I _D = 20A, V _{DS} = 15V, V _{GS} = 4.5V		11.1		nC
Gate-source charge	Q _{gs}			1.9		
Gate-drain ("miller") charge	Q _{gd}			6.8		
Turn-on delay time (Note 2)	t _{d(on)}	V _{DD} = 15V, I _D = 15A V _{GS} = 10V, R _G = 3.3Ω		7.5		nS
Rise time	t _r			14.5		
Turn-off delay time	t _{d(off)}			35.2		
Fall time	t _f			9.6		
Input capacitance	C _{iss}	V _{GS} = 0V, V _{DS} = 25V, f = 1MHz		1160		pF
Output capacitance	C _{oss}			200		
Reverse transfer capacitance	C _{rss}			180		
Gate resistance	R _g	f = 1MHz		2.5	3.5	Ω
Source-drain diode						
Diode forward voltage (Note 2)	V _{SD}	I _S = 20A, V _{GS} = 0V, T _J =25°C			1.2	V
Continuous source current (Note 1, 4)	I _S	V _G = V _D = 0V, Force current			80	A
Pulsed source current (Note 2, 4)	I _{SM}				160	A
Guaranteed avalanche characteristics						
Single pulse avalanche energy (Note 3)	EAS	V _{DD} = 25V, L = 0.1mH, I _{AS} = 20A	20			mJ

- Notes: 1. The data tested by surface mounted on a 1inch² FR-4 board with 2oz copper.
 2. The data tested by pulsed, pulse width ≤ 300μs, duty cycle ≤ 2%.
 3. The min. value is 100% EAS tested guarantee.
 4. The data is theoretically the same as ID and IDM, in real applications, should be limited by total power dissipation.

Rating and Characteristic Curves (CMS80N03H8-HF)

Fig.1 - Typical Output Characteristics

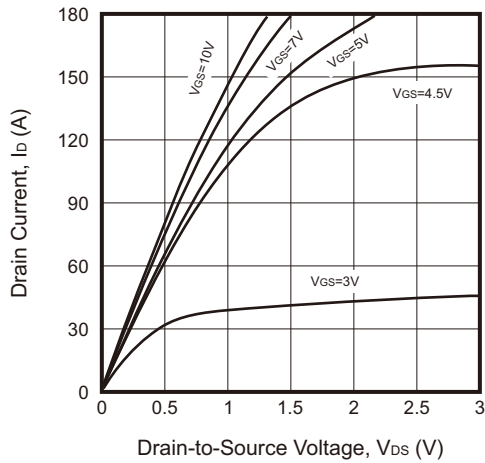

Fig.2 - On-Resistance vs. G-S Voltage

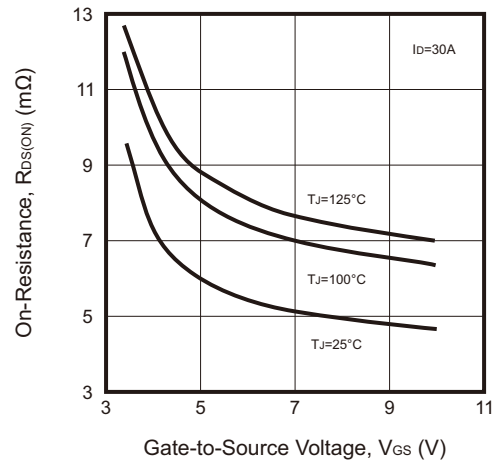

Fig.3 - Normalized $V_{GS(th)}$ vs. T_J

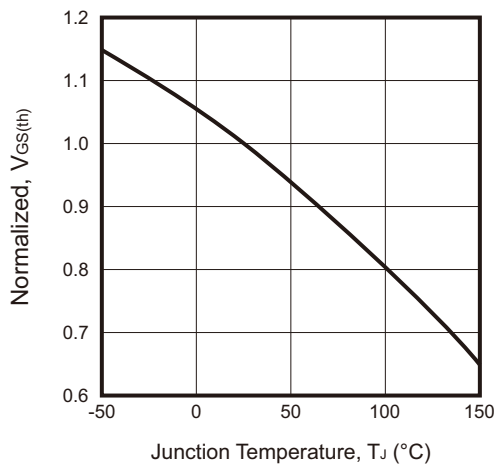

Fig.4 - Normalized $R_{DS(ON)}$ vs. T_J

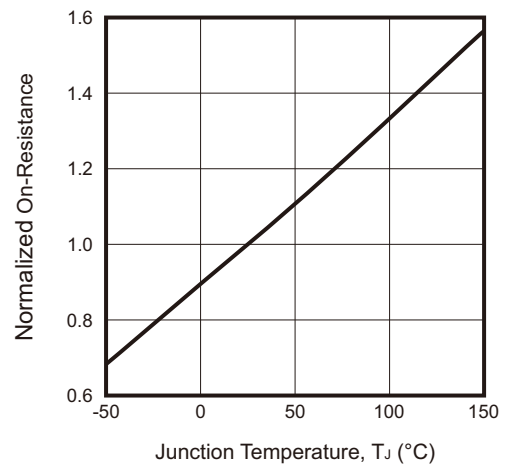

Fig.5 - Safe Operating Area

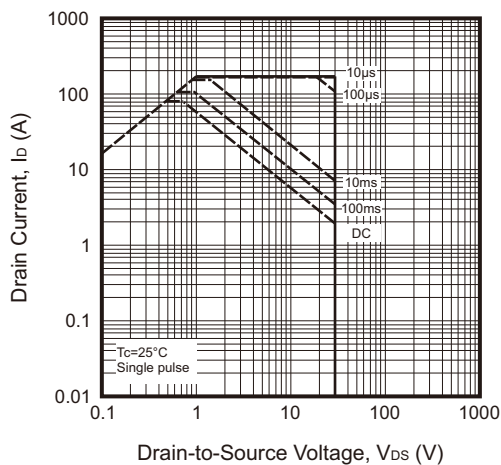
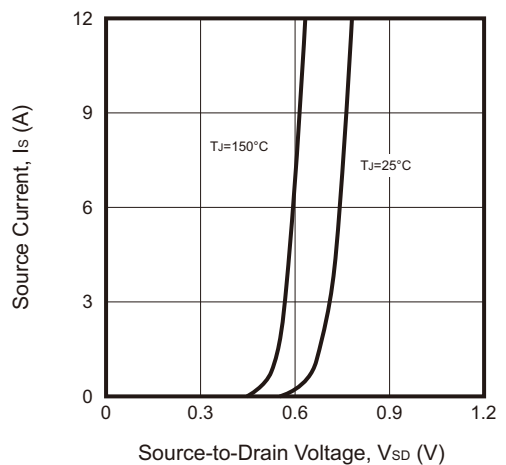

Fig.6 - Forward Characteristics of Reverse



Rating and Characteristic Curves (CMS80N03H8-HF)

Fig.7 - Gate Charge Characteristics

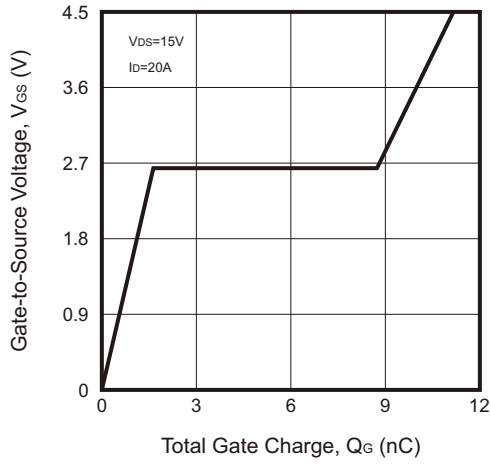
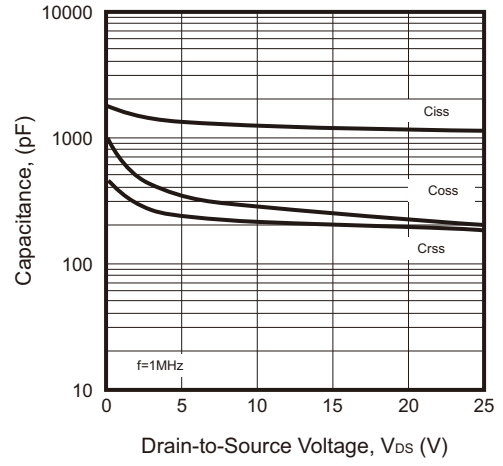
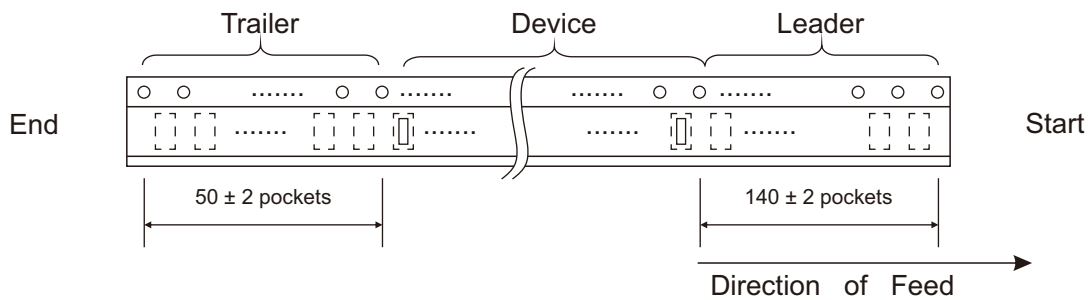
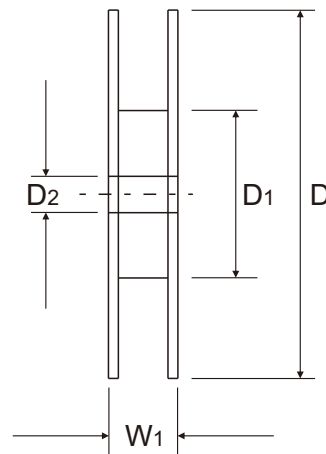
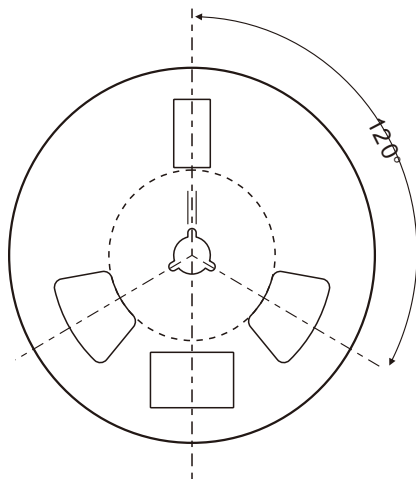
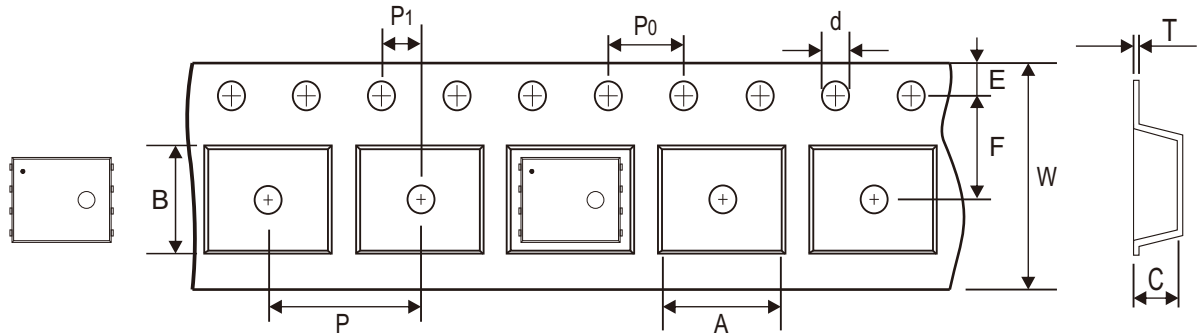

Fig.8 - Capacitance Characteristics



Reel Taping Specification



PR-PAK	SYMBOL	A	B	C	d	D	D1	D2
	(mm)	6.50 ± 0.10	5.30 ± 0.10	1.40 ± 0.10	1.50 + 0.10 - 0.00	330.00 ± 1.00	178.00 + 0.00 - 2.00	13.00 min.
	(inch)	0.256 ± 0.004	0.209 ± 0.004	0.055 ± 0.004	0.059 + 0.004 - 0.000	12.992 ± 0.039	7.008 + 0.000 - 0.079	0.512 min.

PR-PAK	SYMBOL	E	F	P	P0	P1	T	W	W1
	(mm)	1.75 ± 0.10	5.50 ± 0.05	8.00 ± 0.10	4.00 ± 0.10	2.00 ± 0.05	0.30 ± 0.05	12.00 ± 0.30	18.40 ref.
	(inch)	0.069 ± 0.004	0.217 ± 0.002	0.315 ± 0.004	0.157 ± 0.004	0.079 ± 0.002	0.012 ± 0.002	0.472 ± 0.012	0.724 ref.

Company reserves the right to improve product design , functions and reliability without notice. REV:A

Marking Code

Part Number	Marking Code
CMS80N03H8-HF	80N03

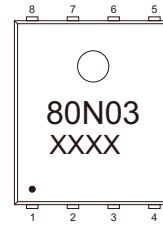

XXXX = Control code

Suggested PAD Layout

SIZE	PR-PAK	
	(mm)	(inch)
A	1.27	0.050
B	0.61	0.024
C	4.42	0.174
D	1.27	0.050
E	6.61	0.260
F	4.32	0.170
G	4.52	0.178
H	3.81	0.150
I	3.91	0.154

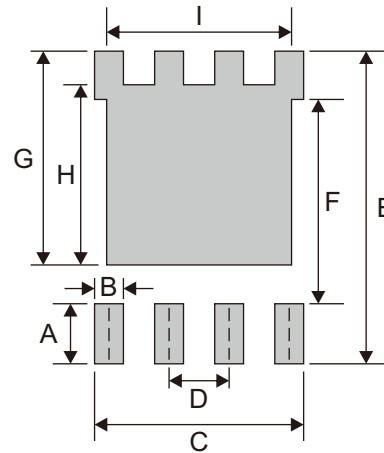

Note: 1. The pad layout is for reference purposes only.

Standard Packaging

Case Type	REEL PACK	
	REEL (pcs)	Reel Size (inch)
PR-PAK	3,000	13