

# SCRs

ID100-ID106

## .5 Amp, Planar

### FEATURES

- Voltage Ratings: to 400V
- Maximum Gate Trigger Current: 200 $\mu$ A
- Hermetically Sealed TO-18 Metal Can
- Planar Passivated Construction

### DESCRIPTION

This Data Sheet describes Microsemi's line of hermetically sealed industrial SCRs designed for low-voltage, low-current sensing application. The ID100 Series is packaged in a TO-18 metal case with Microsemi's unique oxide passivated junctions, offering the highest degree of reliability and parameter stability for any device in its price range. Typical applications include lamp driving, relay driving, sensor, pulse-generating and timing circuits.

### ABSOLUTE MAXIMUM RATINGS

	ID100	ID101	ID102	ID103	ID104	ID105	ID106
Repetitive Peak Off-State Voltage, $V_{DRM}$	30V	60V	100V	150V	200V	300V	400V
Repetitive Peak Reverse Voltage, $V_{RRM}$	30V	60V	100V	150V	200V	300V	400V
On-State Current, $I_T$							
75°C Ambient	250mA						
100°C Case	0.5A						
Repetitive Peak On-State Current, $I_{TRM}$	6A						
Peak One Cycle Surge (Non-Rep.) On-State Current, $I_{TSM}$	up to 30A						
Peak Gate Current, $I_{GM}$	250mA						
Average Gate Current, $I_{G(AV)}$	25mA						
Reverse Gate Voltage, $V_{GR}$	6V						
Storage Temperature Range	-65°C to +150°C						
Operating Temperature Range	-65°C to +125°C						

### MECHANICAL SPECIFICATIONS

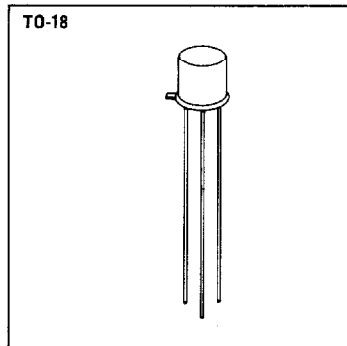
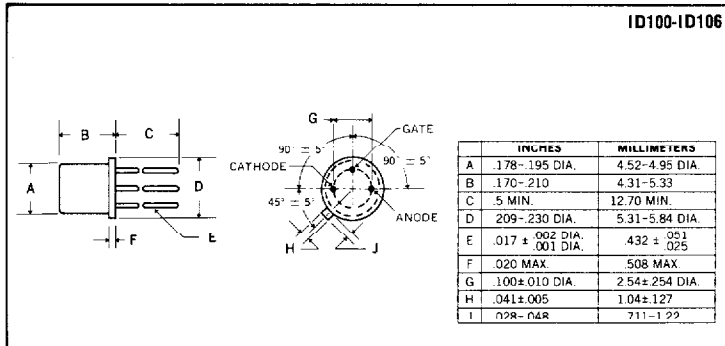

**ELECTRICAL SPECIFICATIONS (at 25°C unless noted)**

Test	Symbol	Min.	Typical	Max.	Units	Test Conditions
Off-State Current	$I_{DRM}$	—	5.0 10.0	50 100	$\mu A$ $\mu A$	$V_{DRM} = \text{Rating}, R_{GK} = 1K, T = 125^\circ C, ID100-ID104$ $V_{DRM} = \text{Rating}, R_{GK} = 1K, T = 125^\circ C, ID105-ID106$
Reversing Current	$I_{RRM}$	—	10 15	50 100	$\mu A$ $\mu A$	$V_{RRM} = \text{Rating}, R_{GK} = 1K, T = 125^\circ C, ID100-ID104$ $V_{RRM} = \text{Rating}, R_{GK} = 1K, T = 125^\circ C, ID105-ID106$
Gate Trigger Current	$I_{GT}$	—	5.0	200	$\mu A$	$V_D = 5V, R_{GS} = 10K$ $V_D = 5V, R_{GS} = 10K, T = -40^\circ C$
Gate Trigger Voltage	$V_{G1}$	0.4 0.10	0.55	0.8 1.0	V V	$V_D = 5V, R_{GS} = 100\Omega$ $V_D = 5V, R_{GS} = 100\Omega, T = -40^\circ C$ $V_D = 5V, R_{GS} = 100\Omega, T = 125^\circ C$
Peak On-State Voltage	$V_{TM}$	—	—	1.7	V	$I_{TM} = 1 \text{ Amp Pulse}$
Holding Current	$I_H$	—	1.0	5.0 10.0	mA mA	$R_{GK} = 1K$ $R_{GK} = 1K, T = -40^\circ C$
Turn-on Time	$t_{on}$	—	0.5	—	$\mu s$	$I_G = 10mA, I_T = 1A, V_D = 30V$
Circuit Commutated Turn-off Time	$t_q$	—	8.0	—	$\mu s$	$I_T = I_R = 1A, R_{GK} = 1K, ID100-ID104$ $I_T = I_R = 1A, R_{GK} = 1K, ID105-ID106$

Note: Blocking voltage ratings apply over the full operating temperature range, provided the gate is connected to the cathode through a resistor, 1000 ohms or smaller, or other adequate bias is used.



Gate Trigger Current vs. Junction Temp.

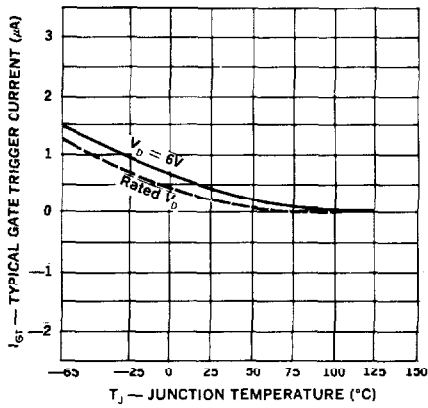

Gate Trigger Voltage vs. Junction Temp.

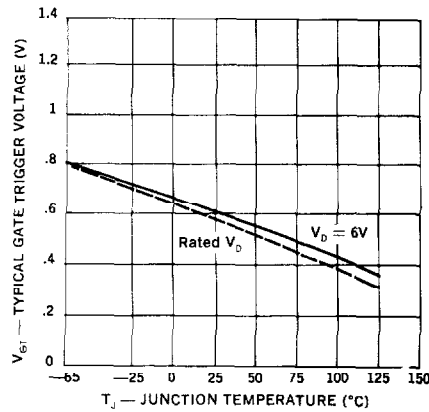

Holding Current vs. Junction Temp.

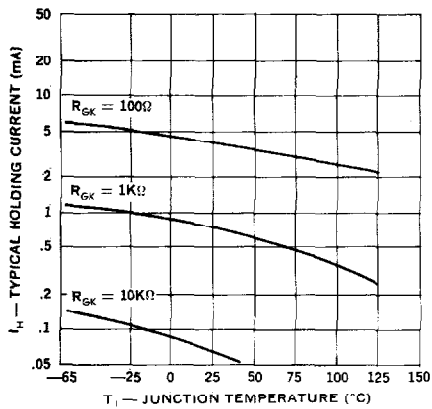

dv/dt vs. Junction Temp.

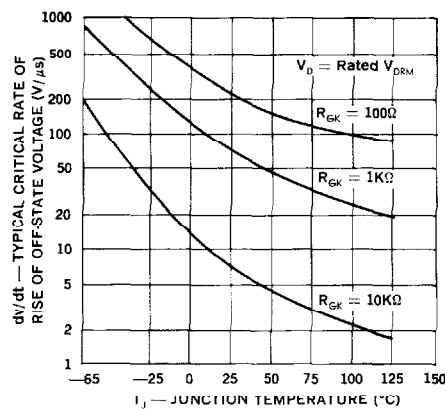

Gate Pulse for Turn-On vs. Pulse Gate Current

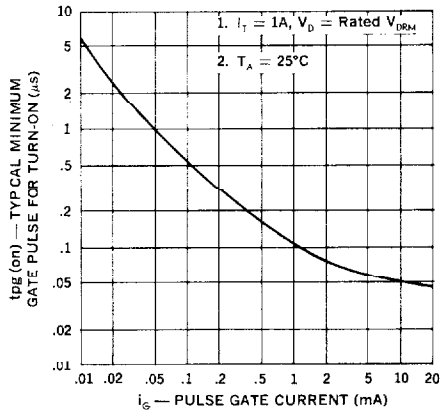

Circuit Commutated Turn-Off Time vs. Junction Temp.

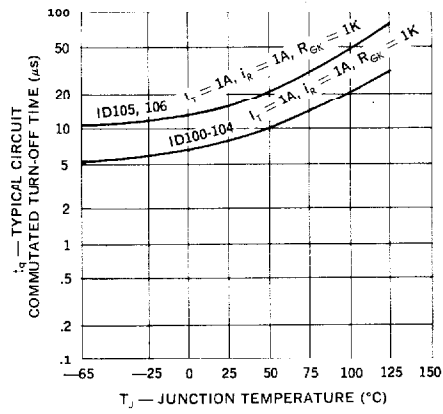

Current vs. On State Voltage

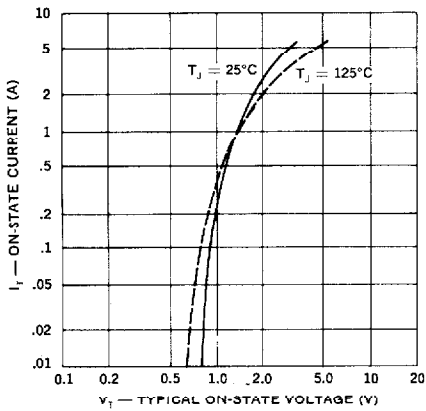

Current vs. Power Dissipation

