

TPS40195 Buck Controller Evaluation Module User's Guide



Table of Contents

1 Introduction	2
2 Description	2
2.1 Applications.....	2
2.2 Features.....	2
3 TPS40195EVM Electrical Performance Specifications	3
4 Schematic	4
4.1 Test Points.....	5
5 Test Setup	5
5.1 Equipment.....	5
5.2 Equipment Setup.....	7
6 Test Procedure	8
6.1 Line and Load Regulation.....	8
6.2 Output Ripple Measurement (TP5, TP13).....	8
6.3 Loop Analysis (TP7, TP8, TP10).....	9
6.4 Disable (TP11) and Power Good (TP9).....	10
6.5 Switch Node (TP4) and SYNC (TP12).....	10
6.6 Equipment Shutdown.....	10
7 TPS40195EVM Typical Performance Data and Characteristic Curves	11
7.1 Line and Load Regulation.....	11
7.2 Efficiency.....	11
7.3 Output Voltage Ripple.....	12
7.4 Transient Response.....	12
7.5 Bode Plots.....	13
7.6 Test Point Waveforms.....	14
8 EVM Assembly Drawings and Layout	15
9 List of Materials	17
10 Revision History	17

Trademarks

All trademarks are the property of their respective owners.

1 Introduction

The TPS40195EVM evaluation module (EVM) is a synchronous buck converter providing a fixed 3.3-V output at up to 20 A from a 12-V input bus. The EVM is designed to start up from a single supply, so no additional bias voltage is required for start up. The module uses the [TPS40195 4.5-V to 20-V Input, Voltage-Mode, Synchronous Buck Controller w/ PGOOD](#) data sheet.

2 Description

The TPS40195EVM is designed to use a regulated 12-V bus (8 V to 20 V) to produce a regulated 3.3-V output at up to 20 A of load current. TPS40195EVM is designed to demonstrate the TPS40195 in a typical 12-V bus to low-voltage application while providing a number of test points to evaluate the performance of the TPS40195 in a given application.

2.1 Applications

- Non-isolated medium current point-of-load and low-voltage bus converters
- Networking equipment
- Telecommunications equipment
- Computer peripherals
- Digital set-top box

2.2 Features

- 8-V to 20-V input range
- 3.3-V fixed output
- 20-A_{DC} steady state output current
- 300-kHz switching frequency
- 2-layer PCB with all components on top side
- Convenient test points for probing switching waveforms and non-invasive loop response testing

3 TPS40195EVM Electrical Performance Specifications

Table 3-1. TPS40195EVM Electrical and Performance Specifications

PARAMETER		CONDITIONS	MIN	NOM	MAX	UNITS
INPUT CHARACTERISTICS						
V_{IN}	Input voltage		8	12	20	V
I_{IN}	Input current	$V_{IN} = 8\text{ V}$, $I_{OUT} = 20\text{ A}$	—	9		A
	No load input current	$V_{IN} = 12\text{ V}$, $I_{OUT} = 0\text{ A}$	—	60		mA
V_{IN_ON}	Input turn-on voltage	$I_{OUT} = 0\text{ A}$ to 20 A	6.3	7.2	8	V
V_{IN_HYS}	Input hysteresis	$I_{OUT} = 0\text{ A}$ to 20 A		1.12		
OUTPUT CHARACTERISTICS						
V_{OUT}	Output voltage	$V_{IN} = 12\text{ V}$, $I_{OUT} = 20\text{ A}$	3.23	3.3	3.36	V
	Line regulation	$V_{IN} = 8$ to 20 V , $I_{OUT} = 20\text{ A}$	—	—	0.5%	
	Load regulation	$V_{IN} = 12\text{ V}$, $I_{OUT} = 0$ to 20 A	—	—	0.5%	
V_{OUT_PP}	Output voltage ripple	$V_{IN} = 12\text{ V}$, $I_{OUT} = 20\text{ A}$	—	—	50	mVpp
I_{OUT}	Output current	$V_{IN} = 8\text{ V}$ to 20 V	0	20	20	A
I_{OCP}	Output overcurrent inception point	$V_{IN} = 12\text{ V}$	20.5	—	—	
TRANSIENT RESPONSE						
ΔI	Load step	20 A to 4 A to 20 A	—	16	—	A
	Load slew rate		—	1	—	A/ μsec
	Over shoot		—	300	—	mV
	Settling time		—	20	—	μs
SYSTEMS CHARACTERISTICS						
F_{SW}	Switching frequency		240	300	360	kHz
η_{pk}	Peak efficiency	$V_{IN} = 12\text{ V}$, $I_{OUT} = 0$ to 20 A	—	95%	—	
η	Full load efficiency	$V_{IN} = 12\text{ V}$, $I_{OUT} = 20\text{ A}$	—	92%	—	
T_{op}	Operating temperature range	$V_{IN} = 8$ to 20 V , $I_{OUT} = 0$ to 20 A , with fan	—	25	—	$^{\circ}\text{C}$

4 Schematic

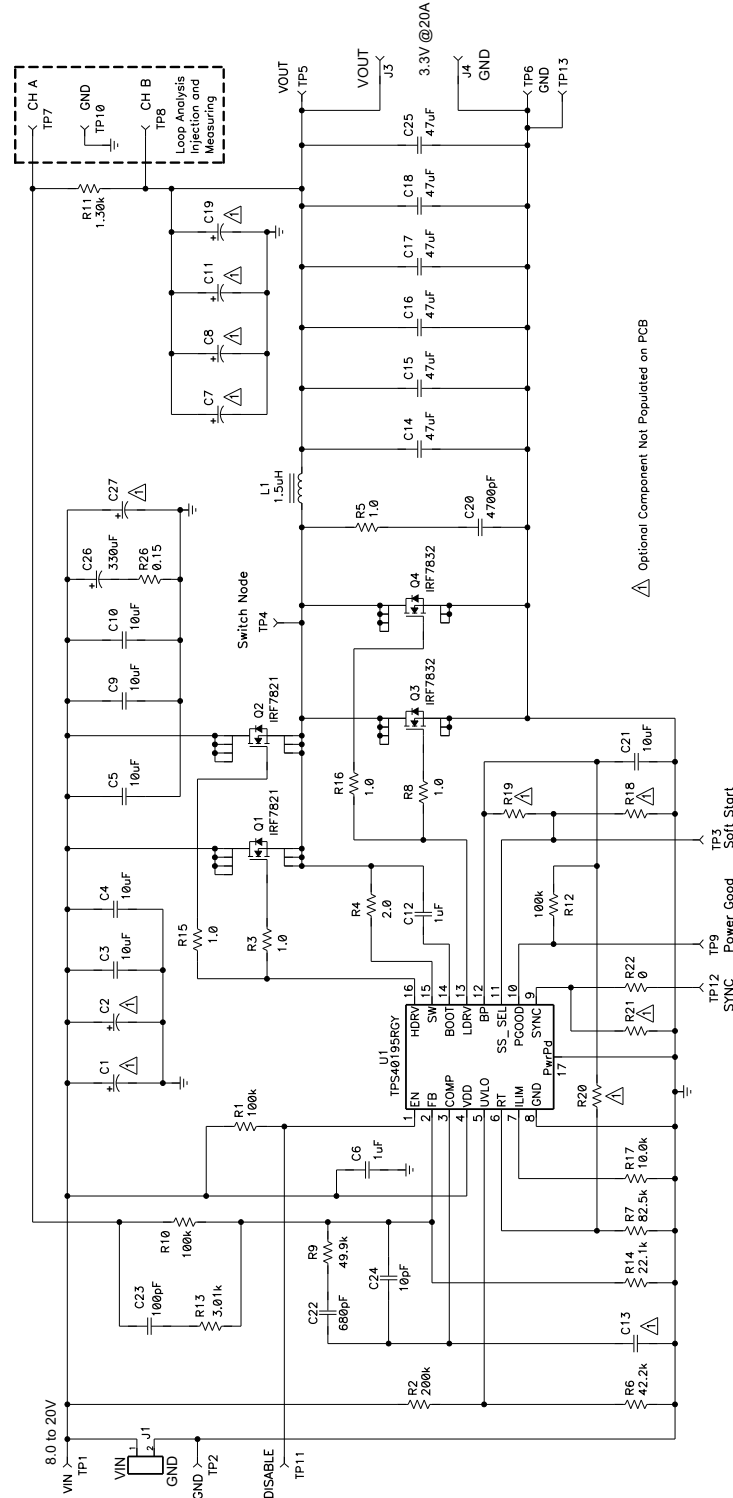

Figure 4-1. TPS40195EVM Schematic for Reference Only, See Table 9-1 List of Materials for Specific Values

4.1 Test Points

Table 4-1. Test Points Available on the TPS40195EVM

TEST POINT	NAME	DESCRIPTION
TP1	VIN	Measure the input voltage at this point.
TP2	GND	Ground connection for input voltage measurements
TP3	Soft Start	Monitor the soft start capacitor voltage.
TP4	Switch Node	Monitor the switch node voltage.
TP5	VOUT	Measure the output voltage and ripple at this point, see Section 6.1 .
TP6	GND	Ground connection for output voltage measurements
TP7	CHA	Input A for loop analysis, see Section 6.3 .
TP8	CHB	Input B for loop analysis, see Section 6.3 .
TP9	Power Good	Monitor power good signal at this point, see Section 6.4 .
TP10	GND	General ground connection
TP11	DISABLE	Short TP11 to TP2 to disable the TPS40195 controller, see Section 6.4 .
TP12	SYNC	Inject square wave synchronizing pulse here, see Section 6.5 .
TP13	GND	Used for output ripple test with TP5, see Section 6.2 .

5 Test Setup

5.1 Equipment

5.1.1 Voltage Source

V_{IN}: The input voltage source (V_{IN}) should be a 0-V to 20-V variable DC source capable of 20 A_{DC}.

5.1.2 Meters

A1: 0 A_{DC} to 20 A_{DC}, ammeter

V1: V_{IN} , 0-V to 20-V voltmeter

V2: V_{OUT} , 0-V to 5-V voltmeter

5.1.3 Loads

LOAD1: The output load (LOAD1) should be an electronic constant current mode load capable of 0 A_{DC} to 20 A_{DC} at 3.3 V.

5.1.4 Oscilloscope

Oscilloscope: A digital or analog oscilloscope can be used to measure the ripple voltage on V_{OUT} . It is also used to monitor various test points around the EVM. [Section 6](#) describes test procedure for these measurements. For ripple measurements it is not recommended to use the leaded ground connection supplied with the oscilloscope. This can induce additional noise due to the large ground loop area.

5.1.5 Signal Generator

A signal generator can be used to synchronous the EVM to a higher switching frequency. See [Section 6](#) for details on doing this.

5.1.6 Recommended Wire Gauge

V_{IN} to J1: The connection between the source voltage, V_{IN} and J1 of the EVM can carry as much as 20 A_{DC}. The minimum recommended wire size is 2x AWG #16 with the total length of wire less than two feet (2-foot input, 2-foot return).

J3 and J4 to LOAD1 (Power): The power connection between J2 of the EVM and LOAD1 can carry as much as 20 A_{DC}. The minimum recommended wire size is 2x AWG #16, with the total length of wire less than two feet (1-foot output, 1-foot return).

5.1.7 Other

Fan: This evaluation module includes components that can get hot to the touch, because this EVM is not enclosed to allow probing of circuit nodes, a small fan capable of 200 LFM to 400 LFM is required to reduce component surface temperatures to prevent user injury. The EVM should not be left unattended while powered. The EVM should not be probed while the fan is not running.

5.2 Equipment Setup

Shown in [Figure 5-1](#) is the basic test setup recommended to evaluate the TPS40195EVM. Please note that although the return for J1 and J4 are the same, the connections should remain separate as shown in [Figure 5-1](#).

1. Working at an ESD workstation, make sure that any wrist straps, bootstraps, or mats are connected referencing the user to earth ground before power is applied to the EVM. Electrostatic smock and safety glasses should also be worn.
2. Prior to connecting the DC input source, V_{IN} , it is advisable to limit the source current from V_{IN} to 20-A maximum. Make sure V_{IN} is initially set to 0 V and connected as shown in [Figure 5-1](#).
3. Connect the ammeter A1 (0-A to 20-A range) between V_{IN} and J1 as shown in [Figure 5-1](#).
4. Connect voltmeter V1 to TP1 and TP2 as shown in [Figure 5-1](#).
5. Connect LOAD1 to J3 and J4 as shown in [Figure 5-1](#). Set LOAD1 to constant current mode to sink 0 A_{DC} before V_{IN} is applied.
6. Connect voltmeter, V2 across TP5 and TP6 as shown in [Figure 5-1](#).
7. Place Fan as shown in [Figure 5-1](#) and turn on, making sure air is flowing across the EVM.

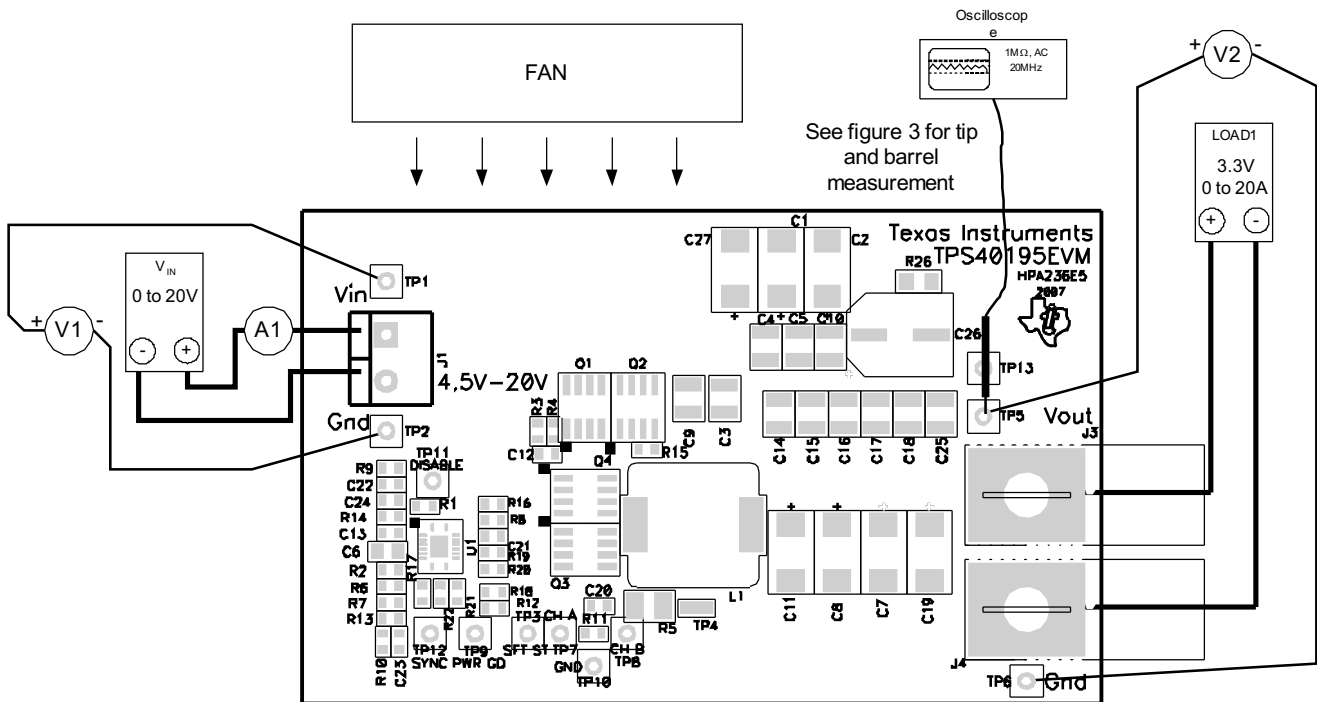

Figure 5-1. TPS40195EVM Recommended Test Setup

6 Test Procedure

6.1 Line and Load Regulation

1. Increase V_{IN} from 0 V to 8 V.
2. Step LOAD1 from 0 A to 20 A.
3. Record, V_{IN} , I_{IN} , V_{OUT} and I_{OUT} for each LOAD1 step.
4. Step V_{IN} from 8 V to 20 V.
5. Repeat 2 to 4 above for each V_{IN} step.
6. See [Section 6.6](#) for equipment shut down.

See [Section 7.1](#) and [Section 7.2](#) for typical line and load regulation curves and efficiency results.

6.2 Output Ripple Measurement (TP5, TP13)

1. Set up the EVM as described in [Section 5.2](#) and [Figure 5-1](#).
2. Set the oscilloscope to the following:
 - 1-M Ω input impedance
 - 20-MHz Bandwidth
 - AC coupling
 - 1- μ s/div horizontal resolution
 - 10-mV/div vertical resolution
3. Place the oscilloscope probe tip through TP5 and hold the ground barrel to TP13 as shown in [Figure 6-1](#). For a hands free approach, the loop in TP13 can be cut and opened to cradle the probe barrel. V2 can have to be removed from these test points to allow the oscilloscope to be connected.
4. Increase V_{IN} to 8 V.
5. Vary LOAD1 from 0 A to 20 A and observe the oscilloscope waveform.
6. Repeat step 5 for various V_{IN} values up to 20 V.
7. See [Section 6.6](#) for equipment shutdown.

See [Section 7.3](#) for typical ripple voltage results

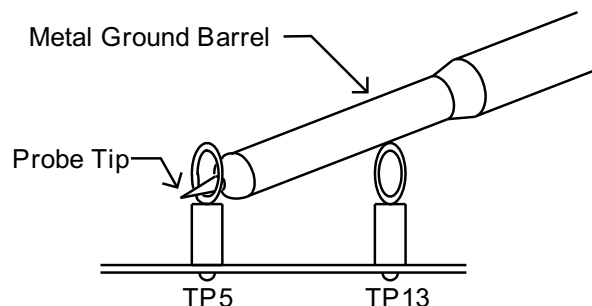

Figure 6-1. Output Ripple Measurement - Tip and Barrel Using TP5 and TP13

6.3 Loop Analysis (TP7, TP8, TP10)

The TPS40195EVM contains a 1.30-k Ω series resistor in the feedback loop to allow for matched impedance signal injection into the feedback for loop response analysis.

1. Set up the EVM as described in [Section 5.2](#) and [Figure 5-1](#).
2. Connect a input signal amplitude measurement probe (Channel A) to TP7 as shown in [Figure 6-2](#).
3. Connect a output signal amplitude measurement probe (Channel B) to TP8 as shown in [Figure 6-2](#).
4. Connect the ground lead of Channel A and Channel B to TP10 as shown in [Figure 6-2](#).
5. Inject 30-mV or less signal across R11 (TP7 and TP8) through an isolation transformer.
6. Sweep frequency from 100 Hz to 1 MHz with 10 Hz or lower post filter.
7. Control loop gain can be measured by $20 \times \text{Log} (\text{ChannelB}/\text{ChannelA})$.
8. Control loop phase is measured by the phase difference between Channel A and Channel B.
9. Disconnect Isolation transformer from TP7 and TP8 before making other measurements (signal injection into feedback may interfere with accuracy of other measurements).
10. See [Section 6.6](#) for equipment shutdown.

See [Section 7.5](#) for typical bode plots and transient performance of this EVM.

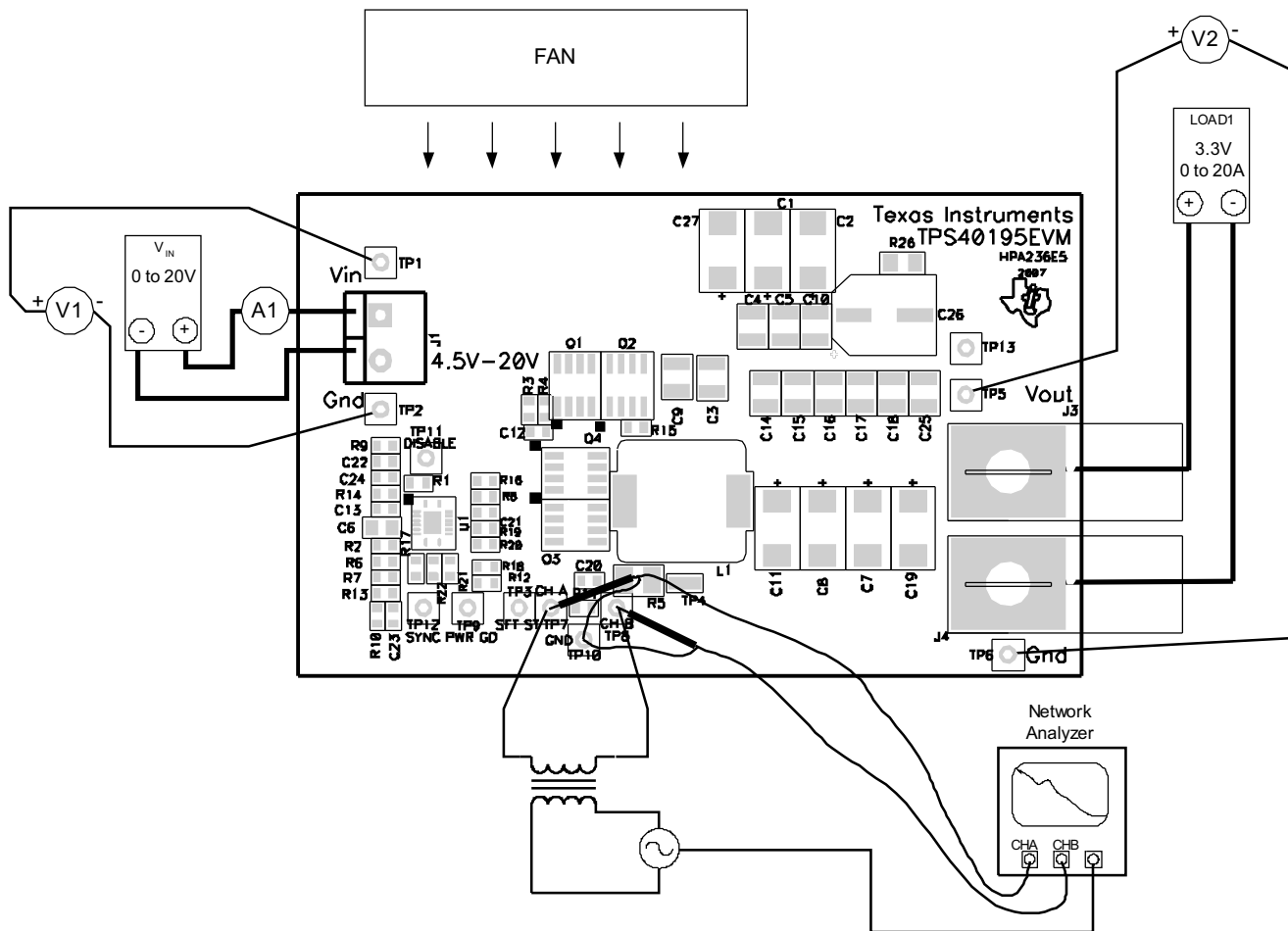

Figure 6-2. Control Loop Measurement Setup

6.4 Disable (TP11) and Power Good (TP9)

The TPS40195EVM defaults to the Enabled state.

1. Set up the EVM as described in [Section 5.2](#) and [Figure 5-1](#).
2. Using a four-channel oscilloscope monitor TP11, TP9, and TP5.
3. Increase V_{IN} to 8 V.
4. Set LOAD1 to 10 A.
5. Short TP11 to TP2. Output should drop to zero.
6. Remove short. Output should return to regulation.
7. Repeat steps 4 and 5 above for various V_{IN} and LOAD1 combinations.
8. See [Section 6.6](#) for equipment shutdown.

See [Section 7.6](#) for typical disable and power good performance.

6.5 Switch Node (TP4) and SYNC (TP12)

1. Set up the EVM as described in [Section 5.2](#) and [Figure 5-1](#).
2. Use the oscilloscope to monitor TP4. Set the oscilloscope to the following:
 - 1-M Ω input impedance
 - 20-MHz Bandwidth
 - AC coupling
 - 1- μ s/div horizontal resolution
 - 5-V/div vertical resolution
3. Increase V_{IN} to 12 V.
4. Set LOAD1 to 10 A.
5. Vary LOAD1 and observe the oscilloscope.
6. Vary V_{IN} and observe the oscilloscope.
7. Set the signal generator to 360 kHz and pulse shape per [Figure 6-1](#).
8. Connect the signal generator to TP12.
9. Monitor TP12 and TP4 with the oscilloscope.
10. Vary signal generator frequency from 360 kHz to 400 kHz.
11. See [Section 6.6](#) for equipment shutdown.

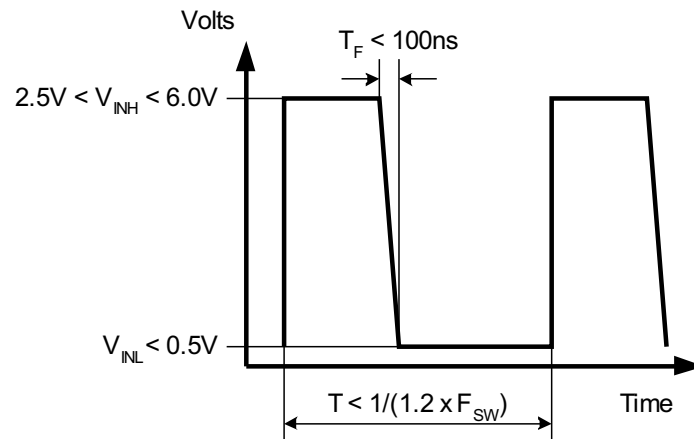

Figure 6-3. Typical TPS40195EVM SYNC Signal. The TPS40195 Synchronizes on the Falling Edge.

6.6 Equipment Shutdown

1. Shut down the oscilloscope.
2. Shut down LOAD1.
3. Shut down V_{IN} .
4. Shut down the fan.

7 TPS40195EVM Typical Performance Data and Characteristic Curves

Figure 7-1 through Figure 7-10 present typical performance curves for the TPS40195EVM. Since actual performance data can be affected by measurement techniques and environmental variables, these curves are presented for reference and may differ from actual field measurements.

7.1 Line and Load Regulation

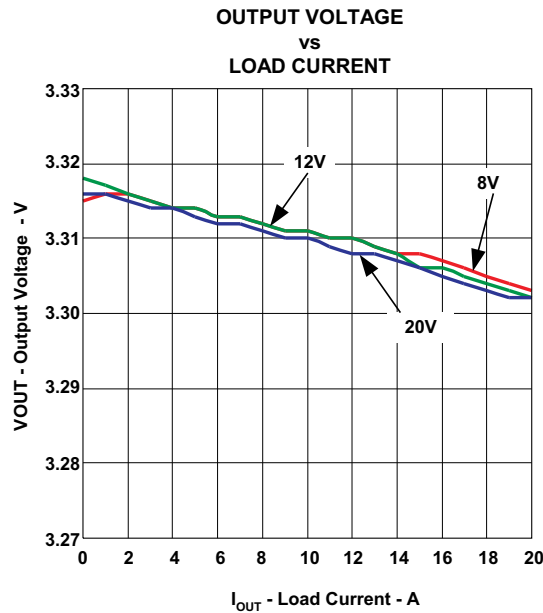

Figure 7-1. TPS40195EVM Line and Load Regulation $V_{IN} = 8\text{ V to }20\text{ V}$, $V_{OUT} = 3.3\text{ V}$, $I_{OUT} = 0\text{ A to }20\text{ A}$

7.2 Efficiency

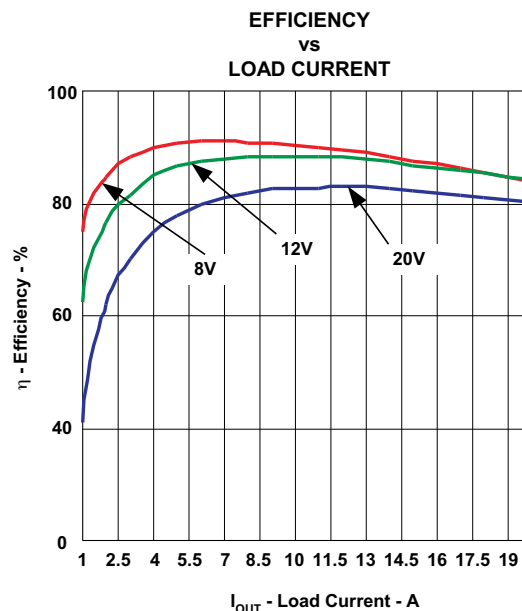

Figure 7-2. TPS40195EVM Efficiency $V_{IN} = 8\text{ V to }20\text{ V}$, $V_{OUT} = 3.3\text{ V}$, $I_{OUT} = 1\text{ A to }20\text{ A}$

7.3 Output Voltage Ripple

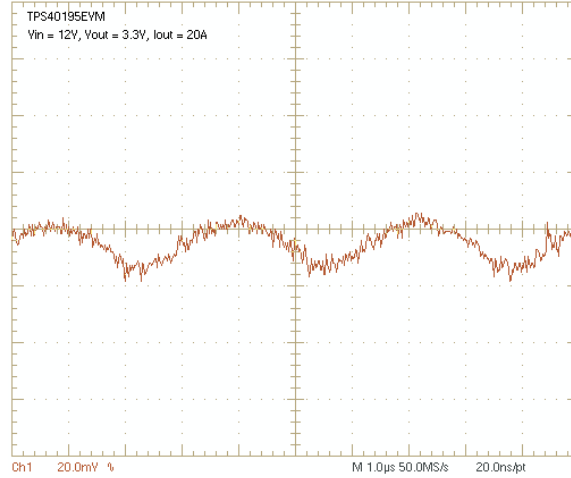

Figure 7-3. TPS40195EVM Output Voltage Ripple ($V_{IN} = 12\text{ V}$, $I_{OUT} = 20\text{ A}$)

7.4 Transient Response

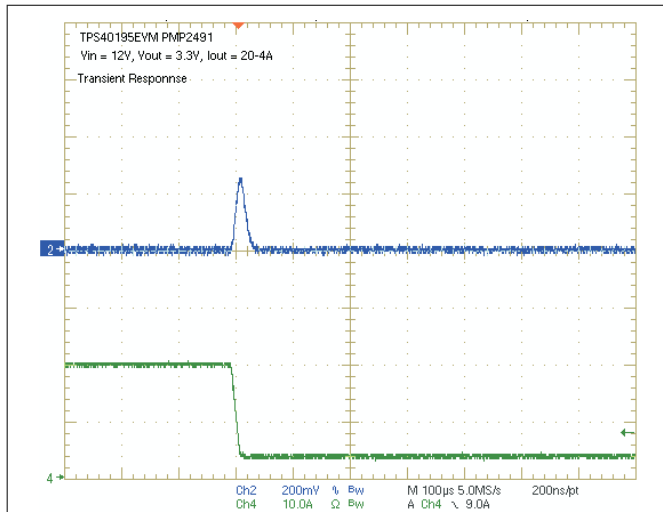

Figure 7-4. TPS40195EVM Transient Response, $V_{IN} = 12\text{ V}$, $I_{OUT} = 20\text{ A}$ to 4 A , Ch1: I_{OUT} , Ch2: V_{OUT}

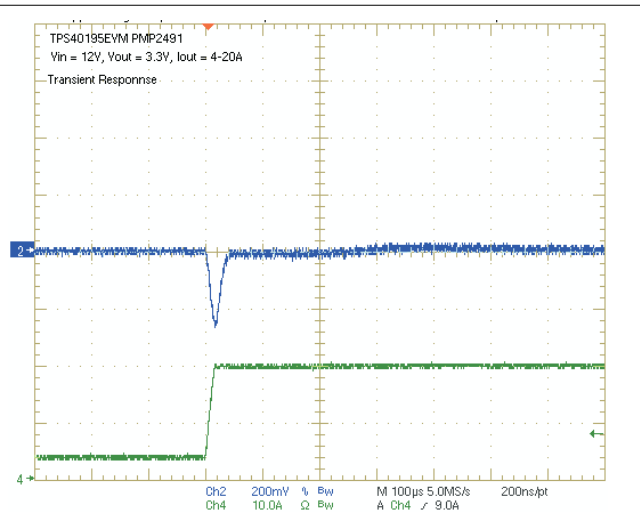

Figure 7-5. TPS40195EVM Transient Response, $V_{IN} = 12\text{ V}$, $I_{OUT} = 4\text{ A}$ to 20 A , Ch1: I_{OUT} , Ch2: V_{OUT}

7.5 Bode Plots

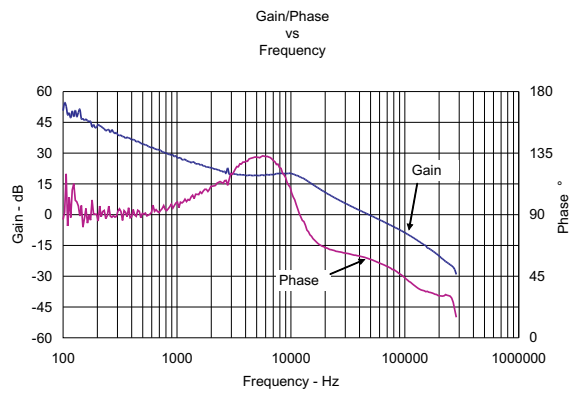

Figure 7-6. TPS40195EVM Bode Plot $V_{IN} = 12\text{ V}$, $I_{OUT} = 20\text{ A}$, Crossover Frequency = 48 kHz, Phase Margin = 57.5°

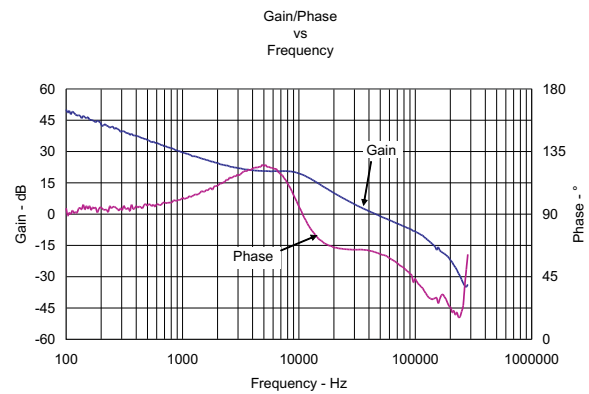

Figure 7-7. TPS40195EVM Bode Plot $V_{IN} = 12\text{ V}$, $I_{OUT} = 0\text{ A}$, Crossover Frequency = 46 kHz, Phase Margin = 62°

7.6 Test Point Waveforms

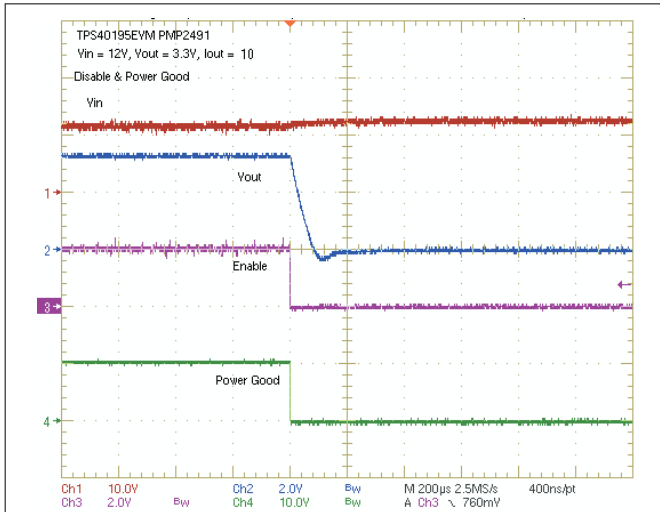

Figure 7-8. TPS40195EVM Disable and Power Good, $V_{IN} = 12\text{ V}$, $I_{OUT} = 10\text{ A}$, Ch1: TP1 (V_{IN}), Ch2: TP5 (V_{OUT}), Ch3: TP11 (ENABLE); Ch4: TP9 (Power Good)

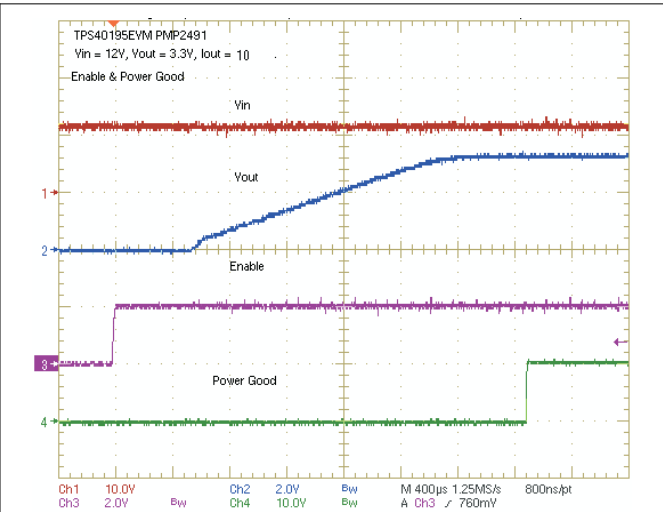

Figure 7-9. TPS40195EVM Enable and Power Good, $V_{IN} = 12\text{ V}$, $I_{OUT} = 10\text{ A}$, Ch1: TP1 (V_{IN}), Ch2: TP5 (V_{OUT}), Ch3: TP11 (ENABLE); Ch4: TP9 (Power Good)

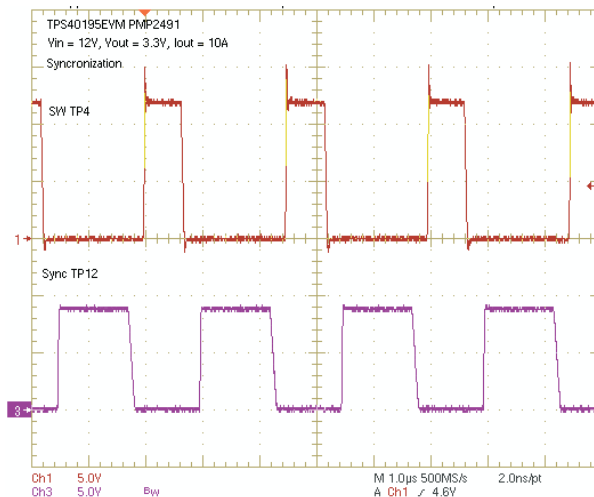

Figure 7-10. TPS40195EVM Switching Waveform (Ch1: TP4) and Synchronization (Ch2: TP12) $V_{IN} = 12\text{ V}$, $I_{OUT} = 10\text{ A}$, $f_{SYNC} = 400\text{ kHz}$

8 EVM Assembly Drawings and Layout

The following figures (Figure 8-1 through Figure 8-3) show the design of the TPS40195EVM printed circuit board. The EVM has been designed using a 2-layer, 2-oz copper-clad circuit board with all components on the top side. Moving components to both sides of the PCB or using additional internal layers can offer additional size reduction for space constrained systems.

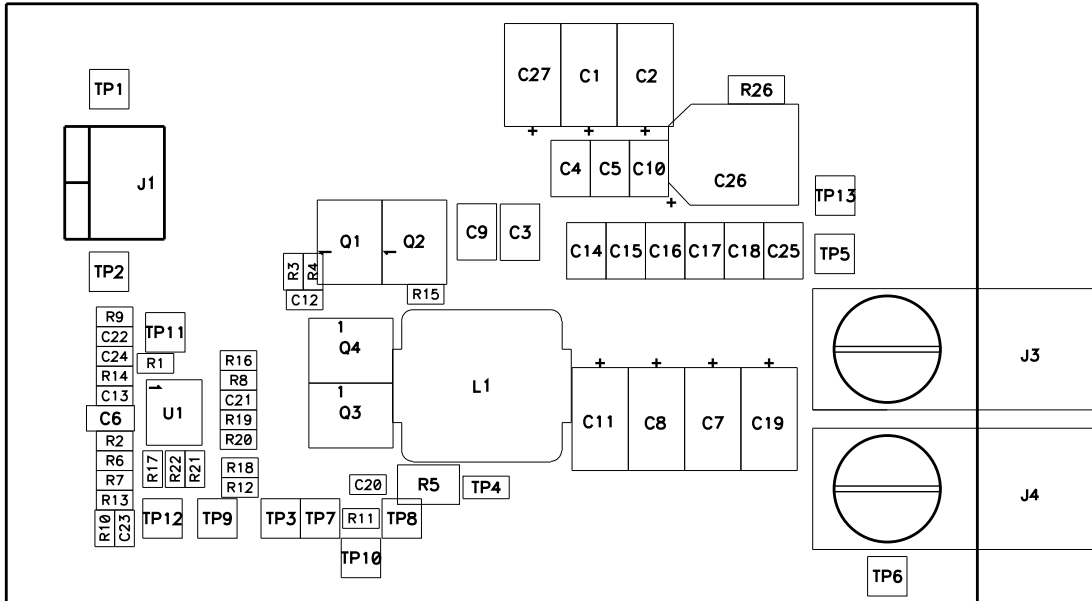

Figure 8-1. TPS40195EVM Component Placement (Viewed from Top)

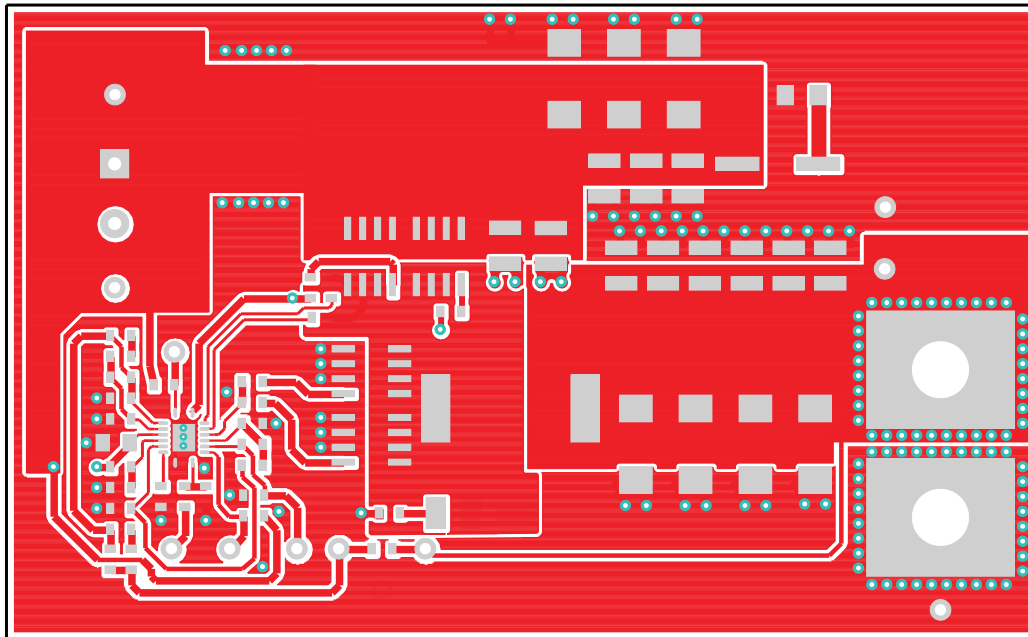

Figure 8-2. TPS40195EVM Top Copper (Viewed from Top)

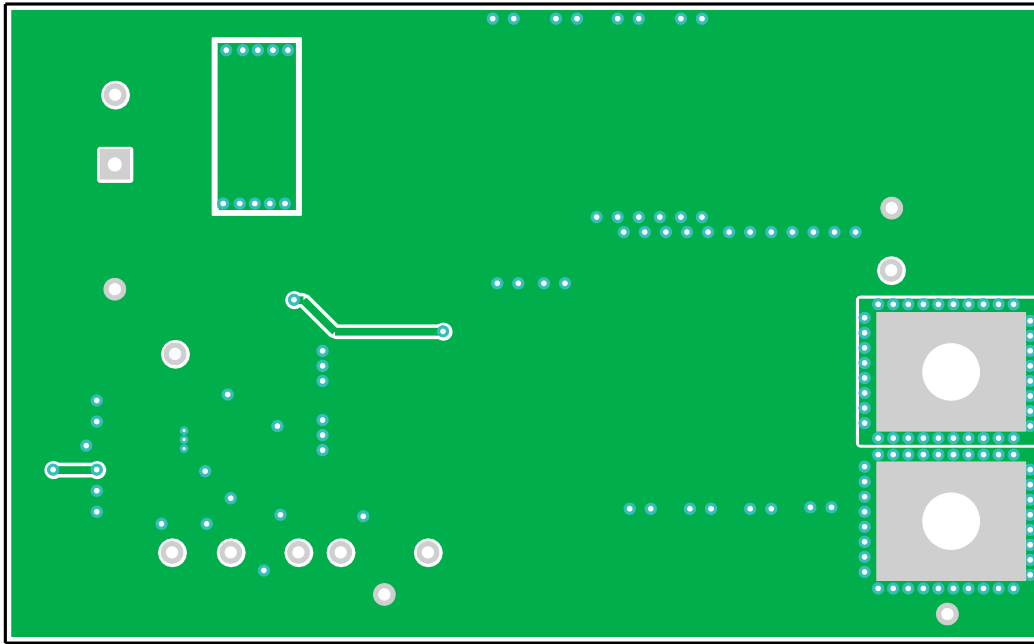

Figure 8-3. TPS40195EVM Bottom Copper (X-ray Viewed from Top)

9 List of Materials

Table 9-1 lists the EVM components as configured according to the schematic shown in Figure 4-1.

Table 9-1. TPS40195EVM List of Materials

COUNT	REF DES	DESCRIPTION	MFR	PART NUMBER
0	C1, C2, C7, C8, C11, C19, C27	Capacitor, aluminum, 20% (UE Series)	Panasonic	EEF-UEvxxxR
1	C12	Capacitor, ceramic, 1.0 μ F, 6.3 V, X7R, 10%, 0603	Std	Std
0	C13	Capacitor, ceramic, OPEN	Std	Std
6	C14, C15, C16, C17, C18, C25	Capacitor, ceramic, 47 μ F, 6.3 V, X5R, 20%, 1210	Std	Std
1	C20	Capacitor, ceramic, 4700 pF, 50 V, [X7R, 10%, 0603	Std	Std
1	C21	Capacitor, ceramic, 10 μ F, 6.3 V, X5R, 10%, 0603	Std	Std
1	C22	Capacitor, ceramic, 680 pF, 50 V, X7R, 10%, 0603	Std	Std
1	C23	Capacitor, ceramic, 100 pF, 50 V, COG, 5%, 0603	Std	Std
1	C24	Capacitor, ceramic, 10 pF, 50 V, NPO, 5%, 0603	Std	Std
1	C26	Capacitor, aluminum, 25 V, \pm 20%, 160 m Ω	Panasonic	EEVFK1E331P
5	C3, C4, C5, C9, C10	Capacitor, ceramic, 10 μ F, 25 V, X7R, 20%, 1210	Std	Std
1	C6	Capacitor, ceramic, 1.0 μ F, 25 V, X7R, 10%, 0805	Std	Std
1	L1	Inductor, SMT, 27 A, 3.0 m Ω	Vishay	IHLP5050FDER1R5M01
2	Q1, Q2	MOSFET, N-channel, 30 V, 11 A, 9.1 m Ω	IR	IRF7821
2	Q3, Q4	MOSFET, N-channel, 30 V, 16 A, 4.0 m Ω	IR	IRF7832
3	R1, R10, R12	Resistor, chip, 100 k Ω , 1/16 W, 1%	Std	Std
1	R11	Resistor, chip, 1.30 k Ω , 1/16 W, 1%	Std	Std
1	R13	Resistor, chip, 3.01 k Ω , 1/16 W, 1%	Std	Std
1	R14	Resistor, chip, 22.1 k Ω , 1/16 W, 1%	Std	Std
1	R17	Resistor, chip, 10.0 k Ω , 1/16 W, 1%	Std	Std
0	R18, R19, R20, R21	Resistor, chip, xxx Ω , 1/16 W, 1%	Std	Std
1	R2	Resistor, chip, 200 k Ω , 1/16 W, 1%	Std	Std
1	R22	Resistor, chip, 0 Ω , 1/16 W	Std	Std
1	R26	Resistor, chip, 0.15 Ω , 1/8 W, 5%	Std	Std
4	R3, R8, R15, R16	Resistor, chip, 1.0 Ω , 1/16 W, 5%	Std	Std
1	R4	Resistor, chip, 2.0 Ω , 1/16 W, 5%	Std	Std
1	R5	Resistor, chip, 1.0 Ω , 1210, 5%	Std	Std
1	R6	Resistor, chip, 42.2 k Ω , 1/16 W, 1%	Std	Std
1	R7	Resistor, chip, 82.5 k Ω , 1/16 W, 1%	Std	Std
1	R9	Resistor, chip, 49.9 k Ω , 1/16 W, 1%	Std	Std
1	U1	TPS40195, 4.5-V to 20-V Sync buck controller with sync and pgood	TI	TPS40195RGY

10 Revision History

NOTE: Page numbers for previous revisions may differ from page numbers in the current version.

Changes from Revision A (July 2008) to Revision B (January 2022)	Page
• Updated the numbering format for tables, figures, and cross-references throughout the document.	2
• Updated the user's guide title.....	2

IMPORTANT NOTICE AND DISCLAIMER

TI PROVIDES TECHNICAL AND RELIABILITY DATA (INCLUDING DATA SHEETS), DESIGN RESOURCES (INCLUDING REFERENCE DESIGNS), APPLICATION OR OTHER DESIGN ADVICE, WEB TOOLS, SAFETY INFORMATION, AND OTHER RESOURCES "AS IS" AND WITH ALL FAULTS, AND DISCLAIMS ALL WARRANTIES, EXPRESS AND IMPLIED, INCLUDING WITHOUT LIMITATION ANY IMPLIED WARRANTIES OF MERCHANTABILITY, FITNESS FOR A PARTICULAR PURPOSE OR NON-INFRINGEMENT OF THIRD PARTY INTELLECTUAL PROPERTY RIGHTS.

These resources are intended for skilled developers designing with TI products. You are solely responsible for (1) selecting the appropriate TI products for your application, (2) designing, validating and testing your application, and (3) ensuring your application meets applicable standards, and any other safety, security, regulatory or other requirements.

These resources are subject to change without notice. TI grants you permission to use these resources only for development of an application that uses the TI products described in the resource. Other reproduction and display of these resources is prohibited. No license is granted to any other TI intellectual property right or to any third party intellectual property right. TI disclaims responsibility for, and you will fully indemnify TI and its representatives against, any claims, damages, costs, losses, and liabilities arising out of your use of these resources.

TI's products are provided subject to [TI's Terms of Sale](#) or other applicable terms available either on ti.com or provided in conjunction with such TI products. TI's provision of these resources does not expand or otherwise alter TI's applicable warranties or warranty disclaimers for TI products.

TI objects to and rejects any additional or different terms you may have proposed.

Mailing Address: Texas Instruments, Post Office Box 655303, Dallas, Texas 75265
Copyright © 2022, Texas Instruments Incorporated