

N-Channel Enhancement Switch Mode RF MOSFET
Low Capacitance Z-MOS™ MOSFET Process
Optimized for RF Operation
Ideal for Class C, D, & E Applications

$V_{DSS} = 600 \text{ V}$
 $I_{D25} = 18 \text{ A}$
 $R_{DS(on)} \leq 0.47 \Omega$
 $P_{DC} = 350 \text{ W}$

Symbol	Test Conditions	Maximum Ratings	
V_{DSS}	$T_J = 25^\circ\text{C}$ to 150°C	600	V
V_{DGR}	$T_J = 25^\circ\text{C}$ to 150°C ; $R_{GS} = 1 \text{ M}\Omega$	600	V
V_{GS}	Continuous	± 20	V
V_{GSM}	Transient	± 30	V
I_{D25}	$T_c = 25^\circ\text{C}$	18	A
I_{DM}	$T_c = 25^\circ\text{C}$, pulse width limited by T_{JM}	90	A
I_{AR}	$T_c = 25^\circ\text{C}$	18	A
E_{AR}	$T_c = 25^\circ\text{C}$	TBD	mJ
dv/dt	$I_S \leq I_{DM}$, $di/dt \leq 100 \text{ A}/\mu\text{s}$, $V_{DD} \leq V_{DSS}$, $T_J \leq 150^\circ\text{C}$, $R_G = 0.2 \Omega$	5	V/ns
	$I_S = 0$	>200	V/ns
P_{DC}		350	W
P_{DHS}	$T_c = 25^\circ\text{C}$, Derate $4.4 \text{ W}/^\circ\text{C}$ above 25°C	240	W
P_{DAMB}	$T_c = 25^\circ\text{C}$	3.0	W
R_{thJC}		0.43	C/W
R_{thJHS}		0.63	C/W

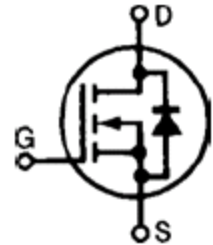
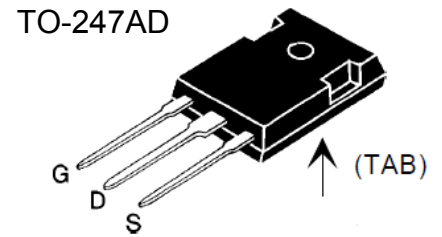

Symbol	Test Conditions	Characteristic Values		
		min.	typ.	max.
$(T_J = 25^\circ\text{C}$ unless otherwise specified)				
BV_{DSS}	$V_{GS} = 0 \text{ V}$, $I_D = 4 \text{ ma}$	600		V
$V_{GS(th)}$	$V_{DS} = V_{GS}$, $I_D = 250 \mu\text{A}$	3.2	4	5.5 V
I_{GSS}	$V_{GS} = \pm 20 \text{ V}_{DC}$, $V_{DS} = 0$			$\pm 100 \text{ nA}$
I_{DSS}	$V_{DS} = 0.8 V_{DSS}$ $V_{GS} = 0$ $= 125 \text{ C}$	$T_J = 25 \text{ C}$ T_J		50 μA
				1 mA
$R_{DS(on)}$	$V_{GS} = 20 \text{ V}$, $I_D = 0.5 I_{D25}$ Pulse test, $t \leq 300 \mu\text{S}$, duty cycle $d \leq 2\%$	0.44	0.47	Ω
g_{fs}	$V_{DS} = 50 \text{ V}$, $I_D = 0.5 I_{D25}$, pulse test	4	5.2	S
T_J		-55		+175 $^\circ\text{C}$
T_{JM}			175	$^\circ\text{C}$
T_{stg}		-55		+175 $^\circ\text{C}$
T_L	1.6mm(0.063 in) from case for 10 s		300	$^\circ\text{C}$
Weight			3.5	g

Features

- IXYS advanced Z-MOS process
- Low gate charge and capacitances
 - easier to drive
 - faster switching
- Low $R_{DS(on)}$
- No beryllium oxide (BeO) or other hazardous materials
- Standard TO-247 packaging

Advantages

- Optimized for RF and high speed
- Easy to mount
- High power density

Symbol	Test Conditions	Characteristic Values ($T_J = 25^\circ\text{C}$ unless otherwise specified)		
		min.	typ.	max.
R_G				1 Ω
C_{iss}			1930	pF
C_{oss}	$V_{GS} = 0\text{ V}, V_{DS} = 0.8 V_{DSS(max)},$ $f = 1\text{ MHz}$		160	pF
C_{rss}			16	pF
C_{stray}	Back Metal to any Pin		33	pF
$T_{d(on)}$			4	ns
T_{on}	$V_{GS} = 15\text{ V}, V_{DS} = 0.8 V_{DSS}$ $I_D = 0.5 I_{DM}$		4	ns
$T_{d(off)}$	$R_G = 1\ \Omega$ (External)		4	ns
T_{off}			6	ns
$Q_{g(on)}$			41	nC
Q_{gs}	$V_{GS} = 10\text{ V}, V_{DS} = 0.5 V_{DSS}$ $I_D = 0.5 I_{D25} I_G = 3\text{ mA}$		15	nC
Q_{gd}			20	nC

Source-Drain Diode		Characteristic Values ($T_J = 25^\circ\text{C}$ unless otherwise specified)		
Symbol	Test Conditions	min.	typ.	max.
I_S	$V_{GS} = 0\text{ V}$			18 A
I_{SM}	Repetitive; pulse width limited by T_{JM}			108 A
V_{SD}	$I_F = I_S, V_{GS} = 0\text{ V},$ Pulse test, $t \leq 300\ \mu\text{s},$ duty cycle $\leq 2\%$			1.5 V
T_{rr}			200	ns

CAUTION: Operation at or above the Maximum Ratings values may impact device reliability or cause permanent damage to the device.

Information in this document is believed to be accurate and reliable. IXYSRF reserves the right to make changes to information published in this document at any time and without notice.

IXYS RF reserves the right to change limits, test conditions and dimensions.

IXYS RF MOSFETS are covered by one or more of the following U.S. patents:

4,835,592	4,860,072	4,881,106	4,891,686	4,931,844	5,017,508
5,034,796	5,049,961	5,063,307	5,187,117	5,237,481	5,486,715
5,381,025	5,640,045	6,404,065	6,583,505	6,710,463	6,727,585
6,731,002					

Fig. 1

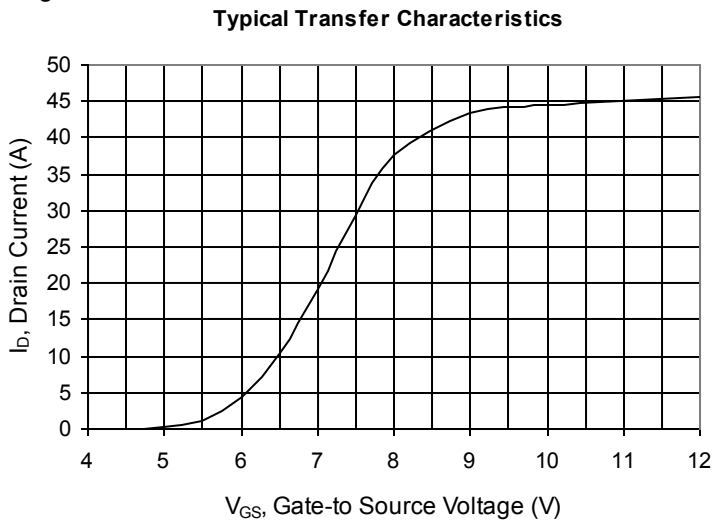

Fig. 2

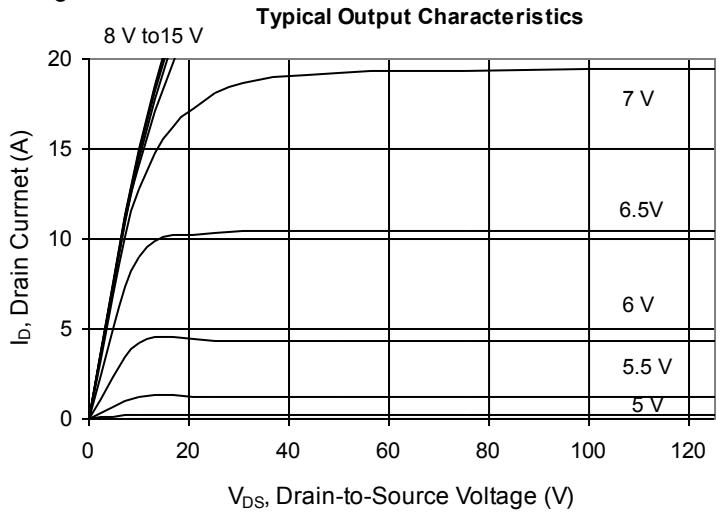

Fig. 3

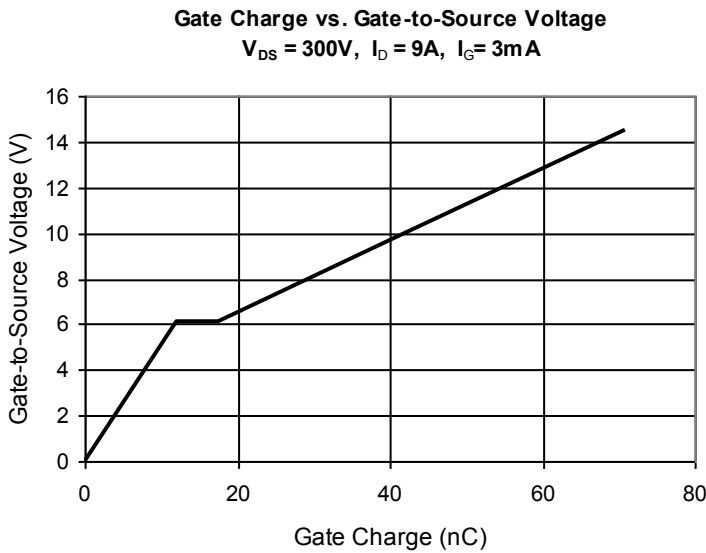

Fig. 4

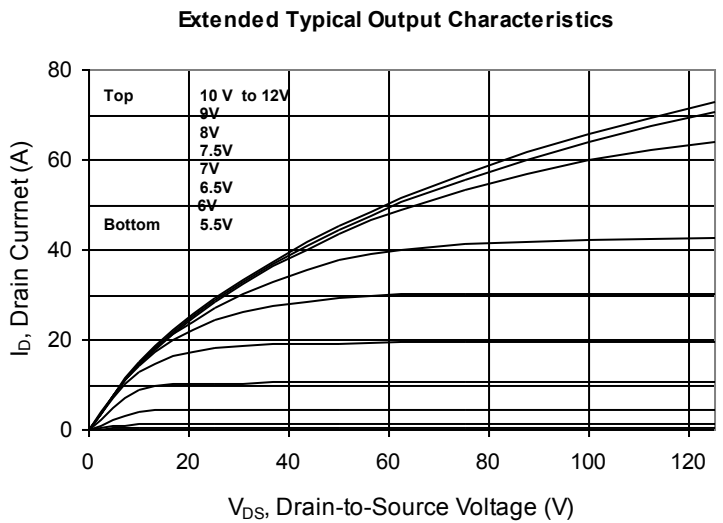

Fig. 5

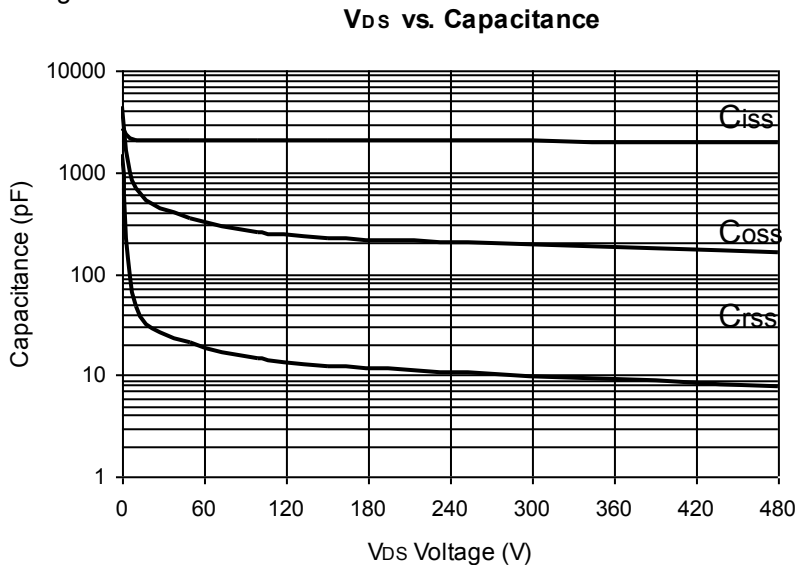
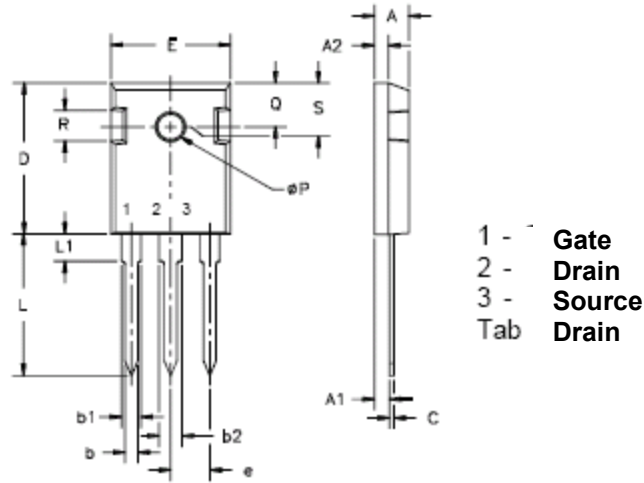

Fig. 6 Package Drawing

TO-247 AD Outline



Dim.	Millimeter		Inches	
	Min.	Max.	Min.	Max.
A	4.7	5.3	.185	.209
A ₁	2.2	2.54	.087	.102
A ₂	2.2	2.6	.059	.098
b	1.0	1.4	.040	.055
b ₁	1.65	2.13	.065	.084
b ₂	2.87	3.12	.113	.123
C	.4	.8	.016	.031
D	20.80	21.46	.819	.845
E	15.75	16.26	.610	.640
e	5.20	5.72	0.205	0.225
L	19.81	20.32	.780	.800
L1		4.50		.177
∅P	3.55	3.65	.140	.144
Q	5.89	6.40	0.232	0.252
R	4.32	5.49	.170	.216
S	6.15	BSC	.242	BSC

Doc #dsIXZH16N60 REV 11/14
©2014 IXYS RF