

1744416-9 ✓ ACTIVE

Economy Power

TE Internal #: 1744416-9

Rectangular Power Connectors, Housing, Receptacle, Wire-to-Board, 9 Position, 3.96 mm [.156 in] Centerline, Wire & Cable, UL 94V-0, Economy Power

[View on TE.com >](#)



Connectors > Power Connectors > Rectangular Power > Rectangular Power Connectors



Rectangular Power Connector Type: **Housing**

Connector & Housing Type: **Receptacle**

Connector System: **Wire-to-Board**

Number of Positions: **9**

Centerline (Pitch): **3.96 mm [.156 in]**

Features

Product Type Features

Rectangular Power Connector Type	Housing
Connector & Housing Type	Receptacle
Connector System	Wire-to-Board
Sealable	No
Connector & Contact Terminates To	Wire & Cable

Configuration Features

Number of Positions	9
Number of Rows	1

Electrical Characteristics

Operating Voltage	600 VAC
-------------------	---------

Contact Features

Contact Layout	Inline
Contact Retention Within Housing	Without
Contact Type	Receptacle



Termination Features

Termination Method to Wire & Cable	Crimp
------------------------------------	-------

Mechanical Attachment

Strain Relief	Without
Mating Alignment Type	Polarization
Mating Retention	With
Mating Alignment	With
Panel Mount Feature	Without
PCB Mount Retention	Without
Mating Retention Type	Latch, Locking Latch
Connector Mounting Type	Cable Mount (Free-Hanging)

Housing Features

Centerline (Pitch)	3.96 mm [.156 in]
Housing Color	Natural
Housing Material	Nylon

Dimensions

Connector Height	11 mm [.432 in]
Product Length	36.2 mm [1.423 in]

Usage Conditions

Operating Temperature Range	-55 – 105 °C [-67 – 221 °F]
-----------------------------	-----------------------------

Operation/Application

Circuit Application	Power & Signal
---------------------	----------------

Industry Standards

UL Flammability Rating	UL 94V-0
Glow Wire Rating	GWT 750°C (Without Flame)

Packaging Features

Packaging Quantity	500
Packaging Method	Bag

Product Compliance

For compliance documentation, visit the product page on [TE.com](https://www.te.com)>











EU RoHS Directive 2011/65/EU	Compliant
EU ELV Directive 2000/53/EC	Compliant
China RoHS 2 Directive MIIT Order No 32, 2016	No Restricted Materials Above Threshold
EU REACH Regulation (EC) No. 1907/2006	Current ECHA Candidate List: JUNE 2023 (235) Candidate List Declared Against: JUNE 2023 (235) Does not contain REACH SVHC
Halogen Content	Not Low Halogen - contains Br or Cl > 900 ppm.
Solder Process Capability	Not applicable for solder process capability

Product Compliance Disclaimer

This information is provided based on reasonable inquiry of our suppliers and represents our current actual knowledge based on the information they provided. This information is subject to change. The part numbers that TE has identified as EU RoHS compliant have a maximum concentration of 0.1% by weight in homogenous materials for lead, hexavalent chromium, mercury, PBB, PBDE, DBP, BBP, DEHP, DIBP, and 0.01% for cadmium, or qualify for an exemption to these limits as defined in the Annexes of Directive 2011/65/EU (RoHS2). Finished electrical and electronic equipment products will be CE marked as required by Directive 2011/65/EU. Components may not be CE marked. Additionally, the part numbers that TE has identified as EU ELV compliant have a maximum concentration of 0.1% by weight in homogenous materials for lead, hexavalent chromium, and mercury, and 0.01% for cadmium, or qualify for an exemption to these limits as defined in the Annexes of Directive 2000/53/EC (ELV). Regarding the REACH Regulation, the information TE provides on SVHC in articles for this part number is based on the latest European Chemicals Agency (ECHA) 'Guidance on requirements for substances in articles' posted at this URL: <https://echa.europa.eu/guidance-documents/guidance-on-reach>

Compatible Parts

 <p>TE Part # 1877285-9 09P EP SHRD HDR ASMY, WHITE</p>	 <p>TE Part # 1-1123724-5 3.96EP HDR ASSY 5(9)P NATURAL</p>	 <p>TE Part # 1744429-9 3.96 EP HDR ASSY 9P W/PEGS, GW</p>	 <p>TE Part # 7-1123724-5 3.96EP HDR ASSY 5(9)P NATURAL, GWT</p>
 <p>TE Part # 647676-9 3.96 EP HDR ASSY 9P R/A</p>	 <p>TE Part # 1744037-9 09P EC PWR.200 CL HDR ASSY VRT</p>	 <p>TE Part # 1744427-9 EP Header Assy,Shrouded,9 Pos, GW</p>	 <p>TE Part # 1-1318300-9 3.96 EP HDR ASSY 9P NAT/TUBE</p>



TE Part # 1-1318301-5
3.96EP HDR ASSY 5(9)P NAT/TUBE



TE Part # 1-1473978-6
EP CONN HDR ASSY 6/9P SPECIAL



TE Part # 1-1565037-6
EP CONN HDR ASSY 6/9P SPECIAL



TE Part # 1-1744498-0
10P EP-II HOUSING, BLACK



TE Part # 1-2316952-9
3.96 EP HDR ASSY 9P, NO PIN 2,4,5



TE Part # 1744048-9
09P EC PWR.200 CL HDR ASSY RA



TE Part # 1744055-9
3.96 EP HDR ASSY 9P VERT HT



TE Part # 1744056-9
3.96 EP HDR ASSY 9P R/A HT



TE Part # 1744057-9
3.96 EP HDR ASSY 9P W/PEGS



TE Part # 1744109-4
3.96 EP Hdr Assy, 9P, Omitted #8, Blue



TE Part # 1744428-9
3.96 EP HDR ASSY 9P R/A, GW



TE Part # 1744489-9
3.96 EP HDR ASY 09P NO PEG, GW

Also in the Series | Economy Power



Connector Contacts(1)



Insertion & Extraction Tools(1)



PCB Headers & Receptacles(162)



PCB Latches, Locks & Retainers(2)



Power Contacts(8)



Rectangular Connector Housings(1)



Rectangular Power Connectors(302)

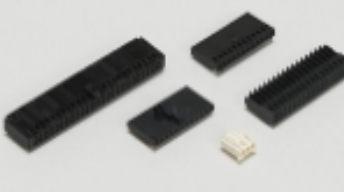

Wire-to-Board Connector Assemblies & Housings(142)

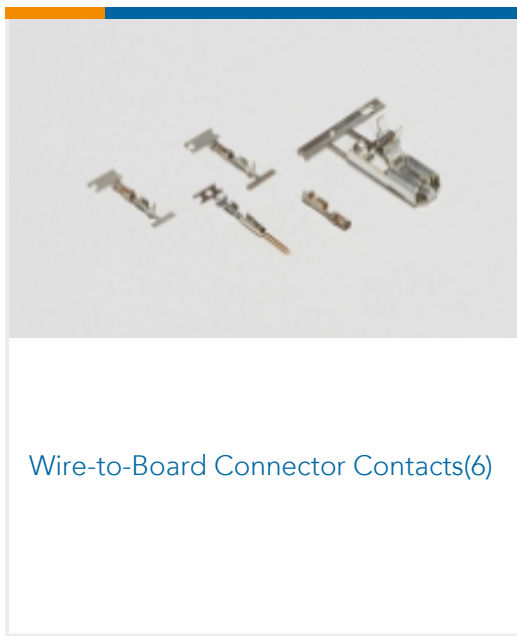

Customers Also Bought

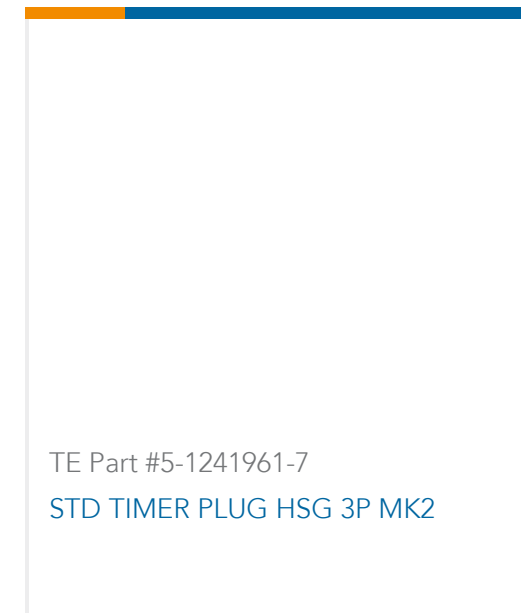
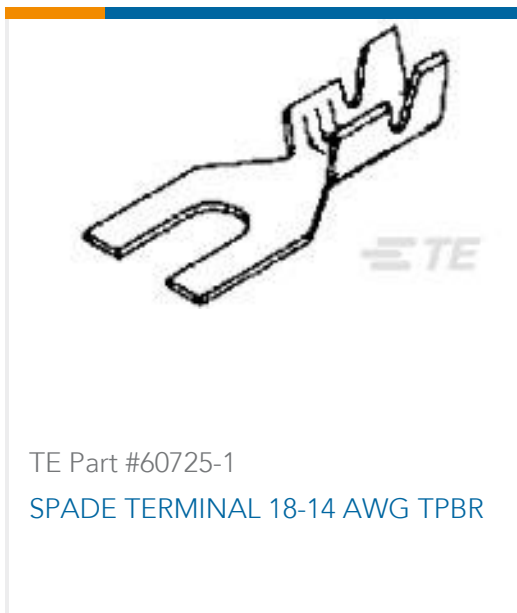

Documents

Product Drawings

9 POS EP II HSG, GLOW WIRE

English

CAD Files

3D PDF

3D

Customer View Model

[ENG_CVM_CVM_1744416-9_E.2d_dxf.zip](#)

English

Customer View Model

[ENG_CVM_CVM_1744416-9_E.3d_igs.zip](#)

English

Customer View Model

[ENG_CVM_CVM_1744416-9_E.3d_stp.zip](#)

English

By downloading the CAD file I accept and agree to the [Terms and Conditions](#) of use.

Datasheets & Catalog Pages

Economy Power II (EP II) Glow Wire test compliant connectors

English

1-1773885-9 Economy Power Connectors

English

Product Specifications

Application Specification



English

Product Environmental Compliance

[MD_1744416-9_061220181218_dmtec](#)

English

[MD_1744416-9_061220181218_dmtec](#)

English

TE Material Declaration

English

Instruction Sheets

[Instruction Sheet \(U.S.\)](#)

English

Agency Approvals

[UL Report](#)

English