



QLSP05WCD  
(3528 PLCC 4 LED)



## Product Outline:

This is the small TOP LED with reflector type with single color led. This special package is ideal for customer's application in traffic signal and sign boards. With special binning technology, Quelighting is able to provide special binning for customer's needs

## Features:

- White color LED
- High brightness output @ 60mA,
- High driving current to 120mA.
- Package Dimension = 3.5mmX2.8mmX1.9mm
- MSL level 2
- RoHS compliant
- Custom Bin available upon special request
- View angel >110°
- AEC-Q101

## Application:

- Architecture Lighting
- Sign board backlighting
- Emergency vehicle lighting
- Traffic signal lighting
- Automotive lighting

## Compliance and Certification:



## Mechanical Property: (Dimension)

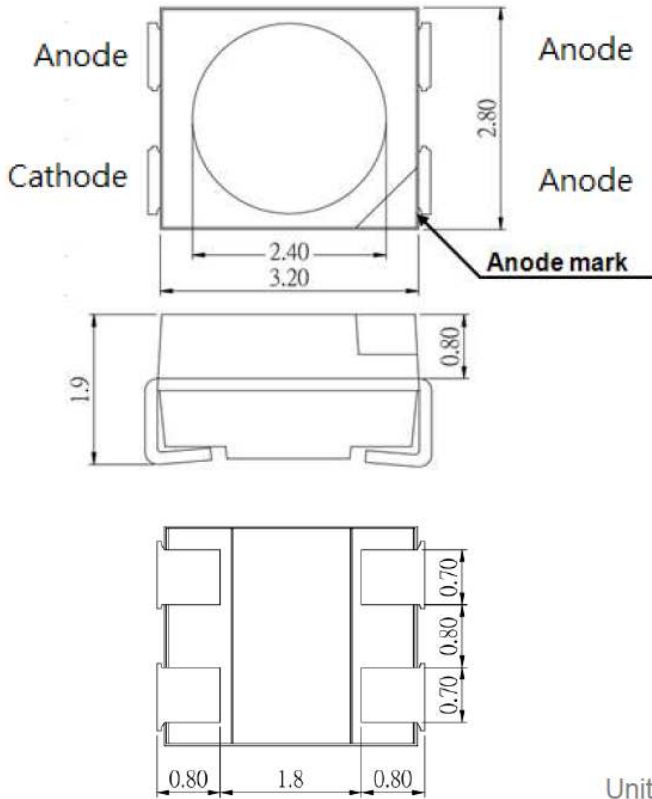

Unit: mm, Tolerance:  $\pm 0.1\text{mm}$

\* All dimensions are in millimeters, \* Tolerances are  $\pm 0.10\text{mm}$ .

## Recommended Solder footprint:

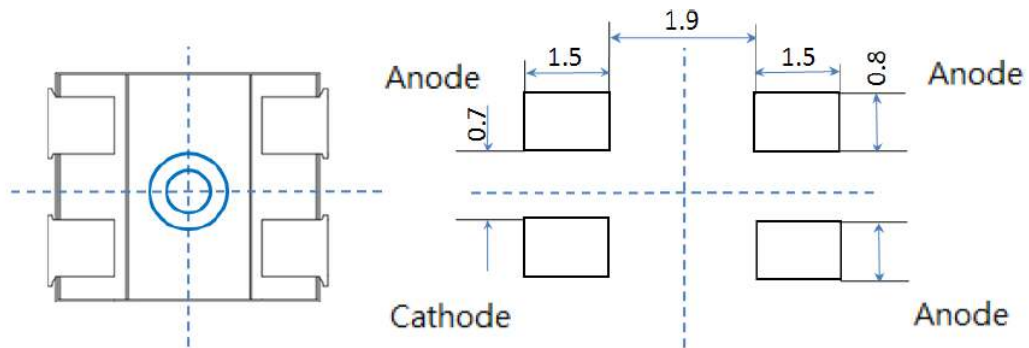

- \* All dimensions are in millimeters.
- \* The LEDs is designed to be reflow soldered on to a PCB. IF dip soldered that QL cannot guarantee its reliability.
- \* Reflow soldering must not be performed more than twice.



## Characteristics

### ■ Absolute Maximum Ratings

(Ta=25°C)

Parameter	Symbol	Rating	Unit
DC Forward Current	If	60	mA
Power Dissipation	Pd	0.2	W
Pulse Forward Current	Ifp	120	mA
Storage Temperature	Tstg	-40 ~ 105	°C
Operation Temperature	Topr	-40 ~ 105	°C
Soldering Temperature	Tsol	260 < 10 sec	°C
ESD (HBM)	ESD(HBM)	8000	V

- (1) Proper current rating must be observed to maintain junction temperature below maximum at all time  
 (2) IFP Condition: Duty 1/10, Pulse within 10msec

### ■ Electrical / Optical Characteristic

(Ta=25 oC)

Parameter	Symbol	Condition	Min.	Typ.	Max.	Unit
Forward Voltage	Vf	60mA	2.7		3.3	V
View Angle	$\theta$			120		deg

- (1) Tolerance of measurement: VF=+/- 0.1V

### ■ Specification

Product	Color	Vf(V) IF=60mA	Color Temperature (K)	Luminous intensity IF=60mA (lm)	
				Min.	Typ.
QLSP05WCD	White	3.2	5000K~7000K	18	22

\*Tolerance = +/- 10%



## ■ Groups

### Dominate Wavelength (nm) Bin:

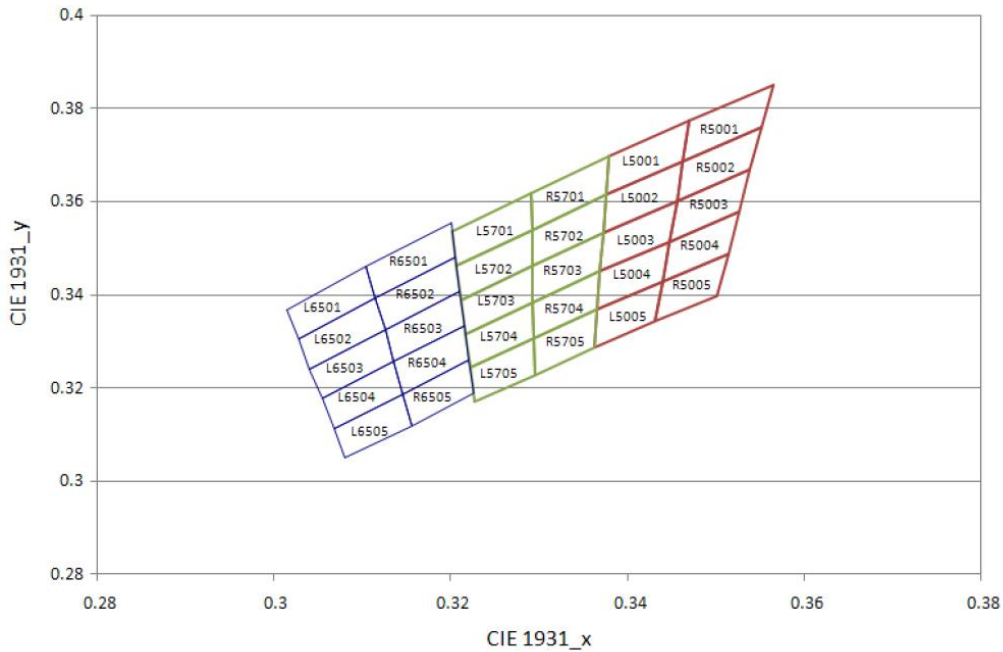

Tolerance of measurements of the Chromaticity Coordinate is  $\pm 0.005$ .

### Forward Voltage ( $V_F$ ) Bin:

VF Rank (V) @ 60mA				Condition
Color	Code name	Low	High	unit
White	A	2.7	2.9	V
	B	2.9	3.1	
	C	3.1	3.3	

The forward voltage tolerance is  $\pm 0.1V$

### Luminous Intensity Bin:

Intensity Rank (lm) @ 60mA			
Code name	Min.	Max.	Units
VS	18	20	lm
VT	20	25	
VU	25	30	



Luminous intensity tolerance is  $\pm 8\%$

## ■ Characteristic Curves

### (1) Color Spectrum

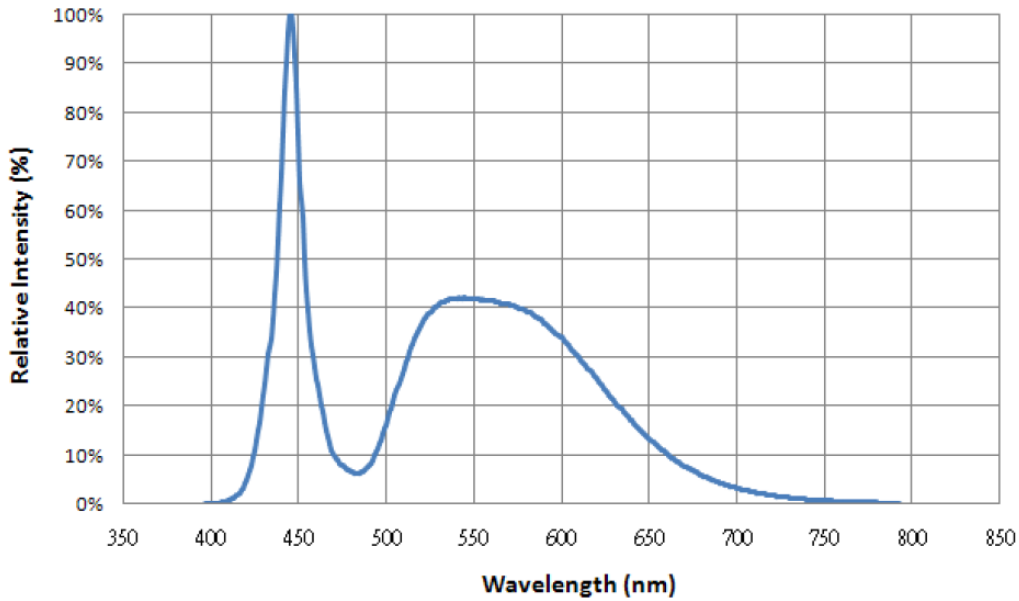

### (2). Typical Representative Spatial Radiation Pattern

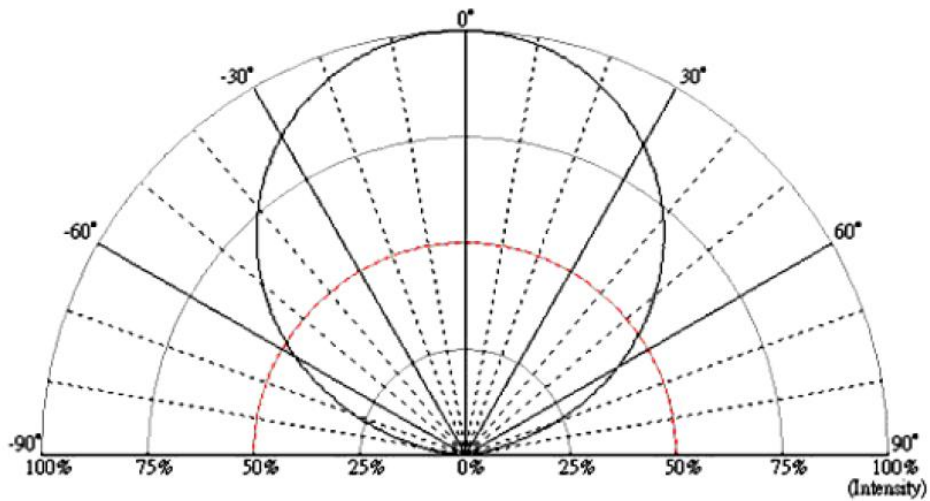

### (3). Forward Current Characteristics

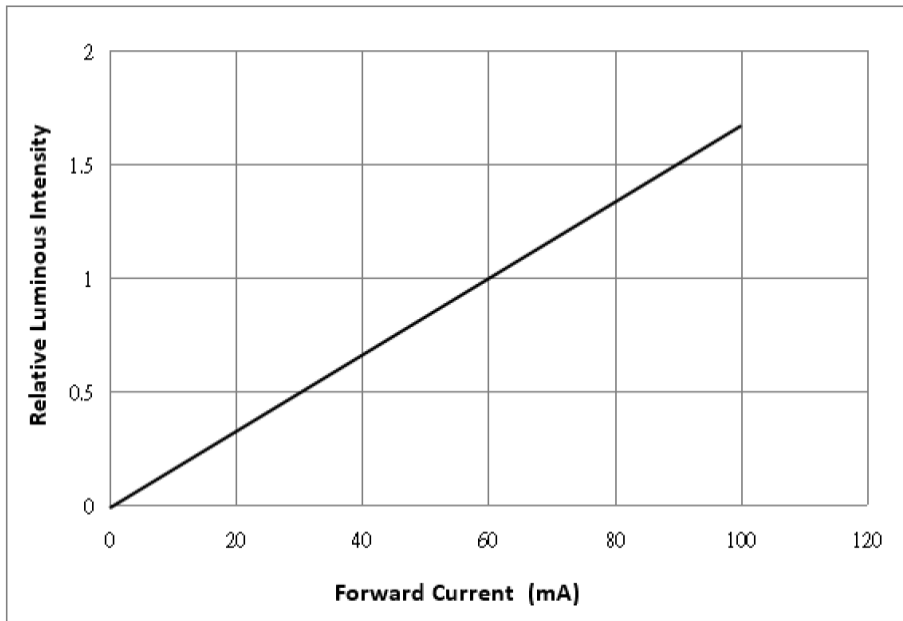

### (4). Forward Current vs Forward Voltage

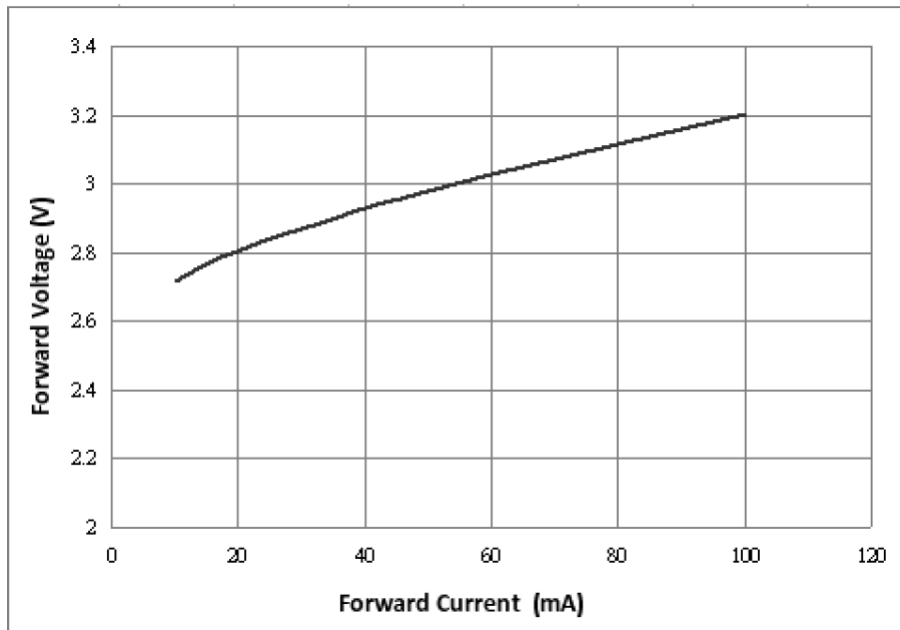

**■ Reliability test:**

No	Item	Condition	Time/Cycle	Sample size
1	Steady State Operating Life of Room Temperature	25°C Operating	1000 Hrs	20 pcs
2	Steady State Operating Life of Low Temperature -40°C	-40°C Operating	1000 Hrs	20 pcs
3	Steady State Operating Life of Low Temperature 60°C	60°C Operating	1000 Hrs	20 pcs
4	Steady State Operating Life of Low Temperature 85°C	85°C Operating	1000 Hrs	20 pcs
5	Low temperature storage -40°C	-40°C Storage	1000 Hrs	20 pcs
6	High temperature storage 100°C	100°C Storage	1000 Hrs	20 pcs
7	Steady State Operating Life of High Humidity Heat 60°C 90%	60°C/90% Operating	1000 Hrs	20 pcs
8	Steady State Pulse Operating Life Condition	25°C 10Hz duty=1/10 Operating	200 Cycle	20 pcs
9	Resistance to soldering heat on PCB (JEDEC MSL3)	pre-store@60°C, 60%RH for 52hrs T <sub>sld</sub> max.=260 10sec	3 Times	20 pcs
10	Heat Cycle Test (JEDEC MRC)	25°C~65°C~-10°C, 90%RH, 24hr/1cycle	10 Cycle	20 pcs
11	Thermal shock	-40°C/ 20minr~ 5minr~100°C /20min	300 Cycle	20 pcs

**■ Judgment Criteria:**

Item	Symbol	Test Condition	Judgment Criteria
Forward Voltage	V <sub>f</sub>	20 mA	ΔV <sub>f</sub> < 10%
Luminous Flux	I <sub>v</sub>	20 mA	ΔI <sub>v</sub> < 30%





■ **Solder Profile:**

-The recommended reflow soldering profile is as follows (temperatures indicated are as measured on the surface of the LED resin):

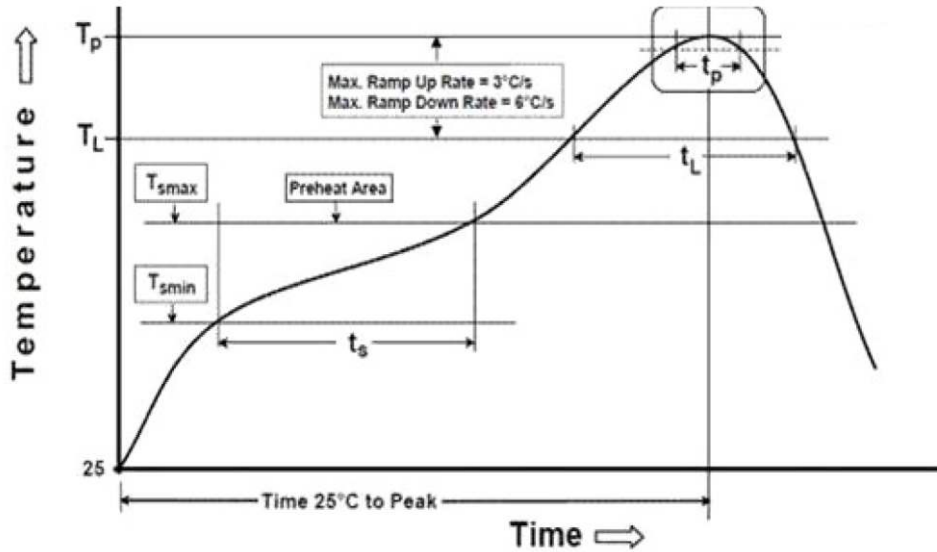

Profile Feature	Sn-Pb Eutectic Assembly	Pb-Free Assembly
Temperature Min( $T_{smin}$ )	100°C	150°C
Temperature Max( $T_{smax}$ )	150°C	200°C
Time( $t_a$ ) from ( $T_{smin}$ to $T_{smax}$ )	60-120 seconds	60-120 seconds
Ramp-up rate( $T_L$ to $T_p$ )	3°C/second max.	3°C/second max.
Liquidous Temperature( $T_L$ )	183°C	217°C
Time( $t_L$ ) maintained above $T_L$	60-150 seconds	60-150 seconds
Peak package body temperature( $T_p$ )	235°C	260°C
Time within 5°C of Actual Peak temperature ( $t_p$ )	20seconds*	30 seconds*
Ramp-down rate( $T_p$ to $T_L$ )	6°C/second max.	6°C/second max.
Time 25°C to peak temperature	6 minutes max.	8 minutes max.
* Tolerance for peak profile temperature ( $T_p$ ) is defined as a supplier minimum and a user maximum.		



■ **Taping & Packing:**

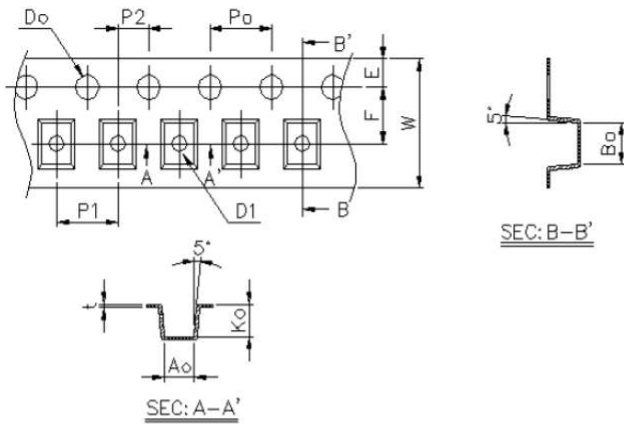

Item	Specification	Tol. (+/-)
W	<b>8.00</b>	± 0.20
E	<b>1.75</b>	± 0.10
F	<b>3.50</b>	± 0.05
D0	<b>1.50</b>	+0.10, -0
D1	<b>1.00</b>	± 0.10
P0	<b>4.00</b>	± 0.05
P1	<b>4.00</b>	± 0.10
P2	<b>2.00</b>	± 0.05
P0 x 10	<b>40.00</b>	± 0.20

t	<b>0.25</b>	± 0.05
A0	<b>3.00</b>	± 0.10
B0	<b>3.73</b>	± 0.10
K0	<b>2.12</b>	± 0.10
A1		
B1		
K1		

Unit : mm



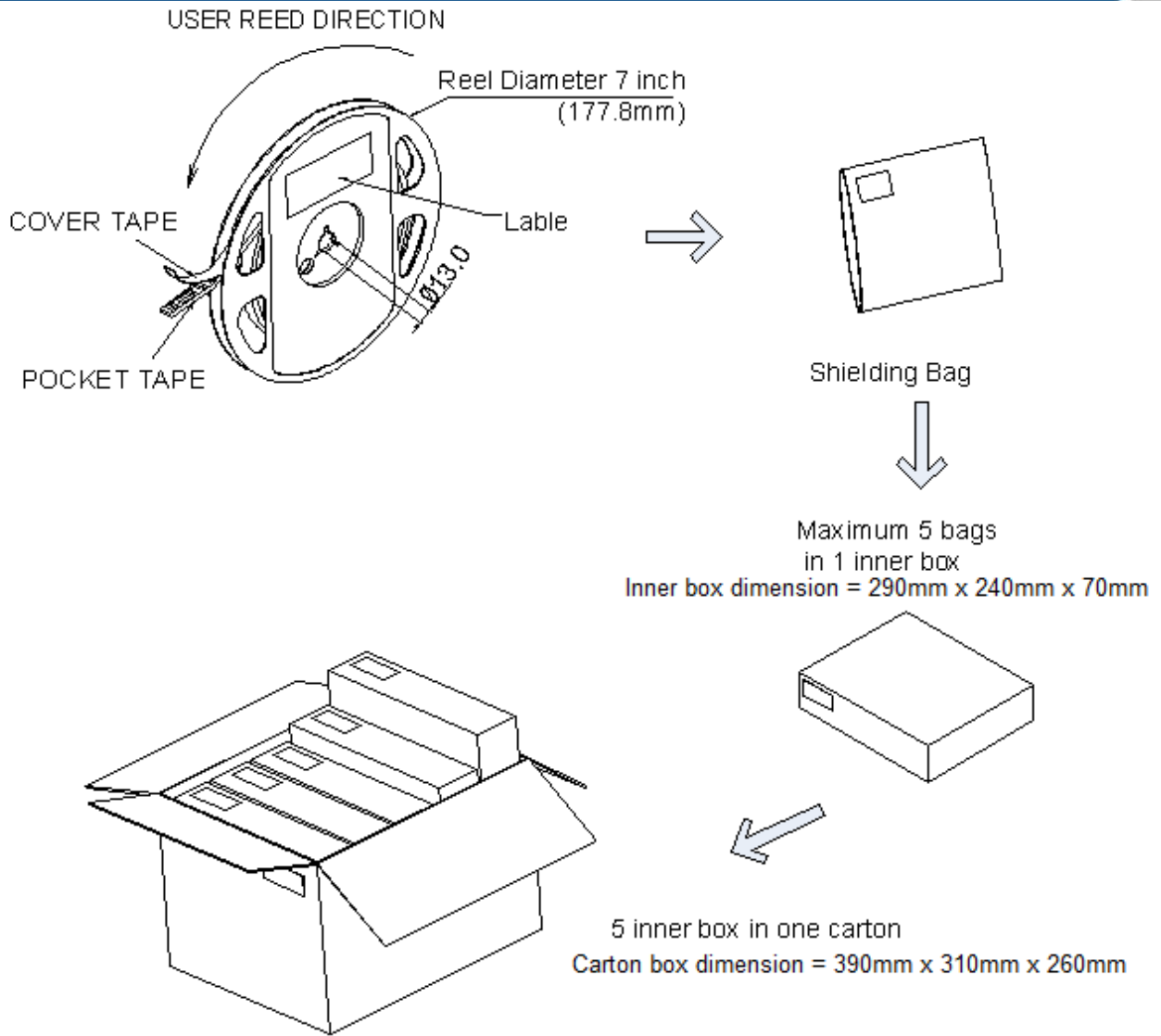

## ■ Labeling

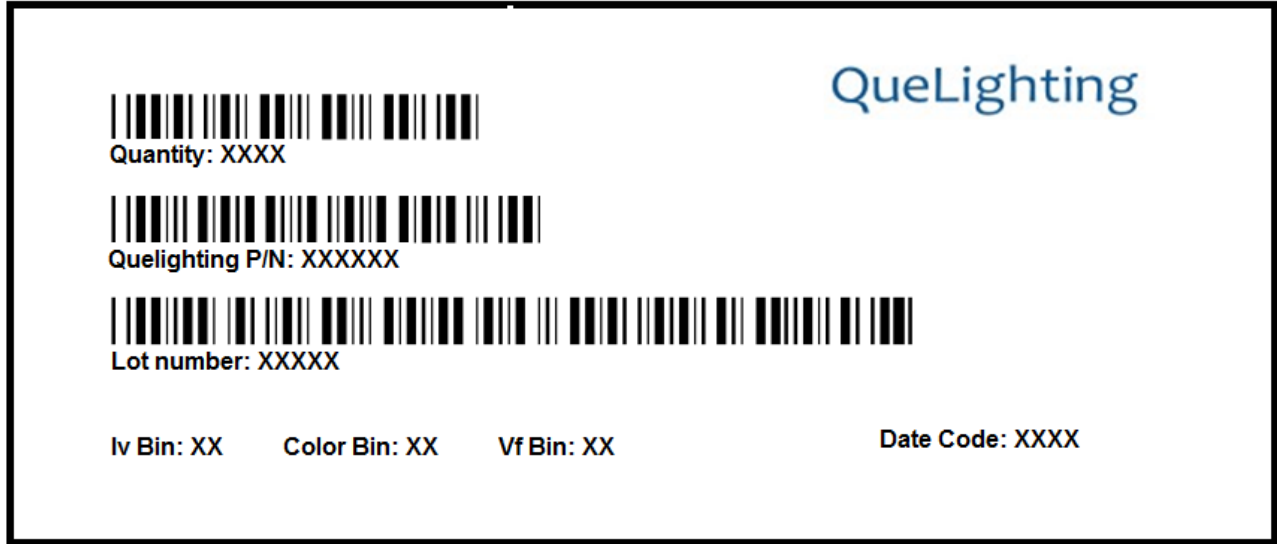

## ■ Ordering Information:

Part #	Multiple Quantities	Quantity per Reel
QLSP05WCD		500,1000,2000 pcs



■ **Revision History:**

<b>Revision Date:</b>	<b>Changes:</b>	<b>Version #:</b>
07-04-2020	Initial release	1.0

