



HiPerFRED²

| | | |
|-----------|---|-------|
| V_{RRM} | = | 200 V |
| I_{FAV} | = | 10 A |
| t_{rr} | = | 35 ns |

High Performance Fast Recovery Diode
Low Loss and Soft Recovery
Single Diode

Part number

DPG10I200PM

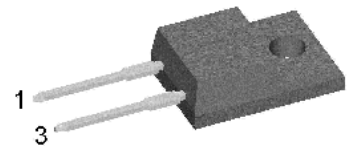

Backside: isolated

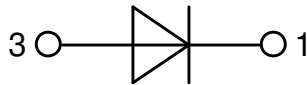

Features / Advantages:

- Planar passivated chips
- Very low leakage current
- Very short recovery time
- Improved thermal behaviour
- Very low I_{rm} -values
- Very soft recovery behaviour
- Avalanche voltage rated for reliable operation
- Soft reverse recovery for low EMI/RFI
- Low I_{rm} reduces:
 - Power dissipation within the diode
 - Turn-on loss in the commutating switch

Applications:

- Antiparallel diode for high frequency switching devices
- Antisaturation diode
- Snubber diode
- Free wheeling diode
- Rectifiers in switch mode power supplies (SMPS)
- Uninterruptible power supplies (UPS)

Package: TO-220FP

- Isolation Voltage: 2500 V~
- Industry standard outline
- RoHS compliant
- Epoxy meets UL 94V-0
- Soldering pins for PCB mounting
- Base plate: Plastic overmolded tab
- Reduced weight

Disclaimer Notice

Information furnished is believed to be accurate and reliable. However, users should independently evaluate the suitability of and test each product selected for their own applications. Littelfuse products are not designed for, and may not be used in, all applications. Read complete Disclaimer Notice at www.littelfuse.com/disclaimer-electronics.



| Fast Diode | | | | Ratings | | | |
|------------|--|---|-------------------------|---------|------|------------|--|
| Symbol | Definition | Conditions | min. | typ. | max. | Unit | |
| V_{RSM} | max. non-repetitive reverse blocking voltage | $T_{VJ} = 25^{\circ}C$ | | | 200 | V | |
| V_{RRM} | max. repetitive reverse blocking voltage | $T_{VJ} = 25^{\circ}C$ | | | 200 | V | |
| I_R | reverse current, drain current | $V_R = 200 V$ | $T_{VJ} = 25^{\circ}C$ | | 1 | μA | |
| | | $V_R = 200 V$ | $T_{VJ} = 150^{\circ}C$ | | 0.06 | mA | |
| V_F | forward voltage drop | $I_F = 10 A$ | $T_{VJ} = 25^{\circ}C$ | | 1.27 | V | |
| | | $I_F = 20 A$ | | | 1.45 | V | |
| | | $I_F = 10 A$ | $T_{VJ} = 150^{\circ}C$ | | 0.98 | V | |
| | | $I_F = 20 A$ | | | 1.17 | V | |
| I_{FAV} | average forward current | $T_C = 125^{\circ}C$ rectangular $d = 0.5$ | $T_{VJ} = 175^{\circ}C$ | | 10 | A | |
| V_{FO} | threshold voltage | } for power loss calculation only | $T_{VJ} = 175^{\circ}C$ | | 0.74 | V | |
| r_F | slope resistance | | | | 17.7 | m Ω | |
| R_{thJC} | thermal resistance junction to case | | | | 4.4 | K/W | |
| R_{thCH} | thermal resistance case to heatsink | | | 0.5 | | K/W | |
| P_{tot} | total power dissipation | | $T_C = 25^{\circ}C$ | | 35 | W | |
| I_{FSM} | max. forward surge current | $t = 10 ms; (50 Hz), sine; V_R = 0 V$ | $T_{VJ} = 45^{\circ}C$ | | 140 | A | |
| C_J | junction capacitance | $V_R = 150 V f = 1 MHz$ | $T_{VJ} = 25^{\circ}C$ | | 15 | pF | |
| I_{RM} | max. reverse recovery current | } $I_F = 10 A; V_R = 130 V$ $-di_F / dt = 200 A/\mu s$ | $T_{VJ} = 25^{\circ}C$ | | 3 | A | |
| | | | $T_{VJ} = 125^{\circ}C$ | | 5.5 | A | |
| t_{rr} | reverse recovery time | | $T_{VJ} = 25^{\circ}C$ | | 35 | ns | |
| | | | $T_{VJ} = 125^{\circ}C$ | | 45 | ns | |



| Package TO-220FP | | Ratings | | | | |
|------------------|--|----------------------|------|------|------|------|
| Symbol | Definition | Conditions | min. | typ. | max. | Unit |
| I_{RMS} | RMS current | per terminal | | | 35 | A |
| T_{VJ} | virtual junction temperature | | -55 | | 175 | °C |
| T_{op} | operation temperature | | -55 | | 150 | °C |
| T_{stg} | storage temperature | | -55 | | 150 | °C |
| Weight | | | | 2 | | g |
| M_D | mounting torque | | 0.4 | | 0.6 | Nm |
| F_C | mounting force with clip | | 20 | | 60 | N |
| $d_{Spp/App}$ | creepage distance on surface striking distance through air | terminal to terminal | 3.2 | 2.7 | | mm |
| $d_{Spb/Apb}$ | | terminal to backside | 2.5 | 2.5 | | mm |
| V_{ISOL} | isolation voltage | t = 1 second | 2500 | | | V |
| | | t = 1 minute | 2100 | | | V |

Product Marking

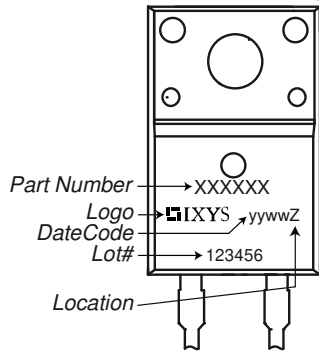

Part description

- D = Diode
- P = HiPerFRED
- G = extreme fast
- 10 = Current Rating [A]
- I = Single Diode
- 200 = Reverse Voltage [V]
- PM = TO-220ACFP (2)

| Ordering | Ordering Number | Marking on Product | Delivery Mode | Quantity | Code No. |
|----------|-----------------|--------------------|---------------|----------|----------|
| Standard | DPG10I200PM | DPG10I200PM | Tube | 50 | 503771 |

| Similar Part | Package | Voltage class |
|--------------|--------------|---------------|
| DPG10I200PA | TO-220AC (2) | 200 |

Equivalent Circuits for Simulation

* on die level

$T_{VJ} = 175^{\circ}C$

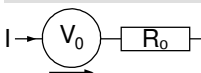

| Symbol | Definition | Fast Diode | Unit |
|--------------|--------------------|------------|------|
| $V_{0\ max}$ | threshold voltage | 0.74 | V |
| $R_{0\ max}$ | slope resistance * | 14.5 | mΩ |



Outlines TO-220FP

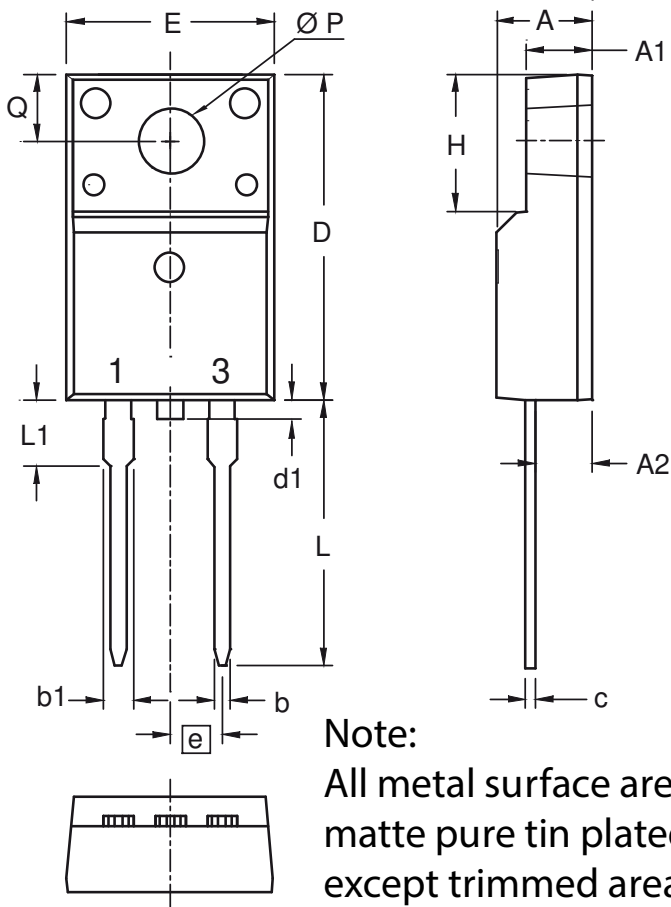

Note:
All metal surface are
matte pure tin plated
except trimmed area.

| Dim. | Millimeters | | Inches | |
|------|-------------|-------|-----------|-------|
| | min | max | min | max |
| A | 4.50 | 4.90 | 0.177 | 0.193 |
| A1 | 2.34 | 2.74 | 0.092 | 0.108 |
| A2 | 2.56 | 2.96 | 0.101 | 0.117 |
| b | 0.70 | 0.90 | 0.028 | 0.035 |
| b1 | 1.27 | 1.47 | 0.050 | 0.058 |
| c | 0.45 | 0.60 | 0.018 | 0.024 |
| D | 15.67 | 16.07 | 0.617 | 0.633 |
| d1 | 0 | 1.10 | 0 | 0.043 |
| E | 9.96 | 10.36 | 0.392 | 0.408 |
| e | 2.54 BSC | | 0.100 BSC | |
| H | 6.48 | 6.88 | 0.255 | 0.271 |
| L | 12.68 | 13.28 | 0.499 | 0.523 |
| L1 | 3.03 | 3.43 | 0.119 | 0.135 |
| ØP | 3.08 | 3.28 | 0.121 | 0.129 |
| Q | 3.20 | 3.40 | 0.126 | 0.134 |

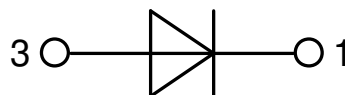

Fast Diode

 Fig. 1 Forward current I_F versus V_F

 Fig. 2 Typ. reverse recov. charge Q_{rr} versus $-di_F/dt$

 Fig. 3 Typ. reverse recov. current I_{RR} versus $-di_F/dt$

 Fig. 4 Typ. dynamic parameters Q_{rr} , I_{RR} versus T_{VJ}

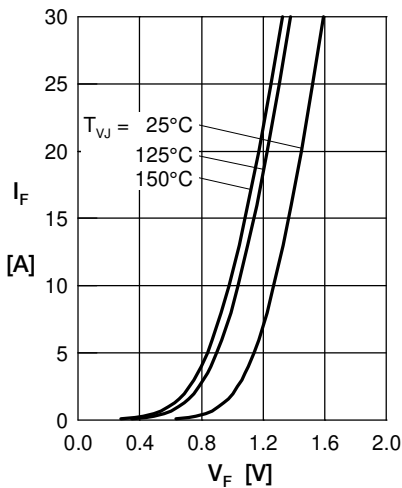
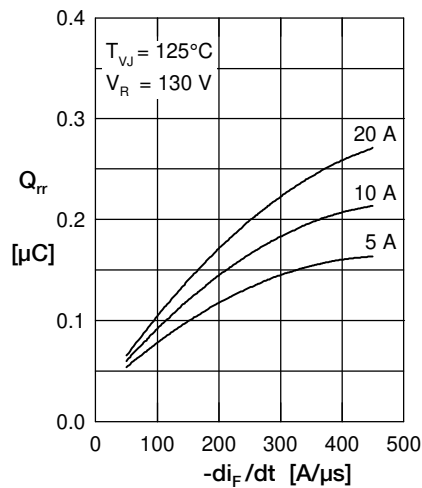
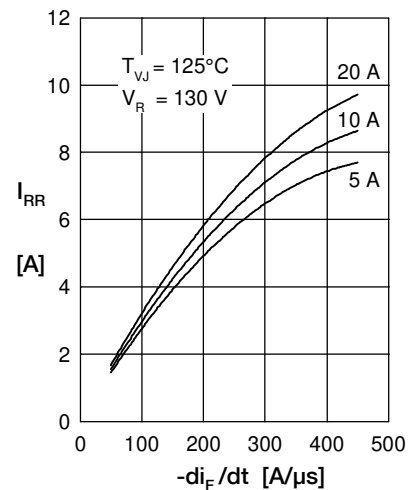
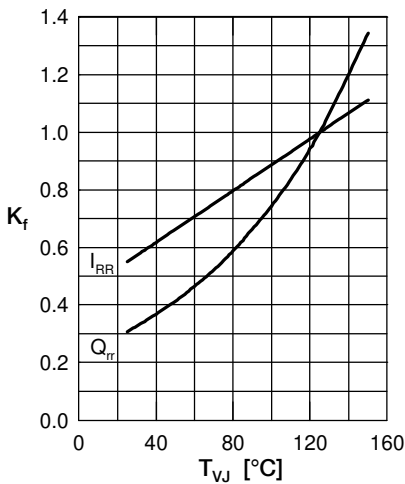
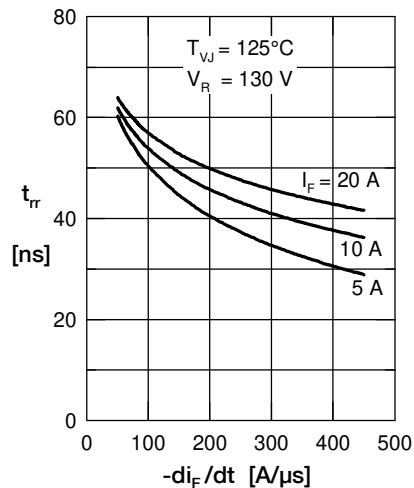
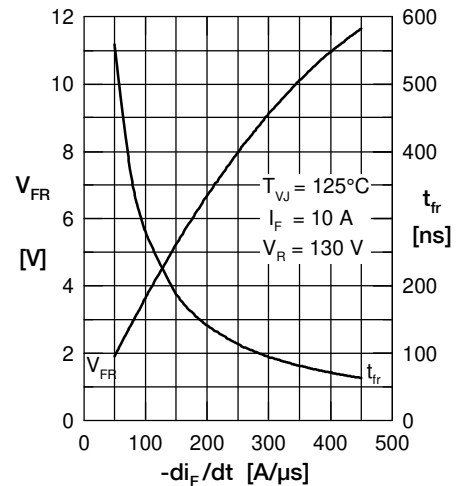
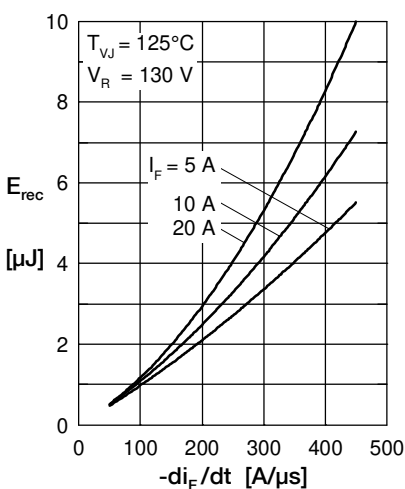
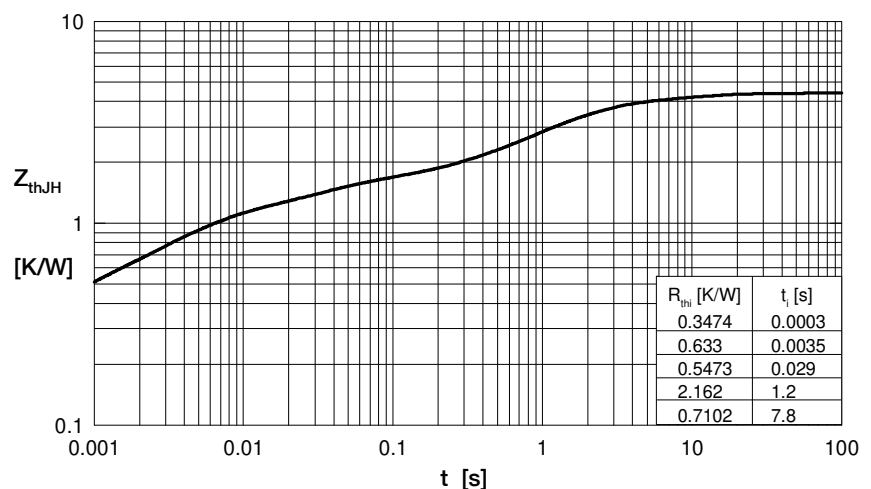
 Fig. 5 Typ. reverse recov. time t_{rr} versus $-di_F/dt$

 Fig. 6 Typ. forward recov. voltage V_{FR} and t_{fr} versus di_F/dt

 Fig. 7 Typ. recovery energy E_{rec} versus $-di_F/dt$

Fig. 8 Transient thermal resistance junction to case