

Programmable - High Performance SMD XO & VCXO (LVPECL Output)

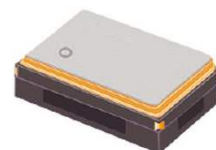

2.5 x 2.0 x 1.0 mm

ASG2-P



Moisture Sensitivity Level (MSL) – 1

FEATURES:

- +2.5V or +3.3V operation
- -40°C to +85°C standard operating temperature range
- Miniature size 2.5 x 2.0 x 1.0 mm Ceramic SMT Package
- Short lead time

APPLICATIONS:

- Networking
- SONET/SDH
- WiMax / WLAN
- Computing
- Phase Locked Loops
- Direct Digital Synthesis (DDS)
- DSL/ADSL
- Base Terminal Stations

STANDARD SPECIFICATIONS:

Parameters		Minimum	Typical	Maximum	Units	Notes
Frequency Range		8		1500	MHz	
Operating Temperature		-40		+85	°C	
Storage Temperature		-55		+125	°C	
Overall Frequency Stability		-50		+50	ppm	<i>See Note # 1</i>
Initial Tolerance + Stability over operating temperature		-35.00		+35.00	ppm	
Supply Voltage (V _{dd})	V _{dd} = 3.3V	3.135	3.300	3.465	V	
	V _{dd} = 2.5V	2.375	2.500	2.625	V	
Input Current				65	mA	Frequency dependent
LVPECL Output (OUT & OUT)	Output High Voltage	V _{dd} - 1.025			V	50Ω nominal load
	Output Low Voltage			V _{dd} - 1.62	V	50Ω nominal load
	Duty Cycle	45		55	%	@V _{dd} -1.3V
	Rise Time			600	ps	80%/20%
	Fall Time			600	ps	80%/20%
Enable/Disable Function :		"1" (V _{IH} ≥ 0.7*V _{dd}) or Open: Oscillation "0" (V _{IL} < 0.3*V _{dd}) : High Z				
Control Voltage Range		0		V _{dd}	V	For VCXO Only
Absolute Pull Range		±35			ppm	For VCXO Only
Control Port Bandwidth		10			kHz	For VCXO Only
Linearity				15	%	For VCXO Only
Slope		Positive				For VCXO Only
Phase jitter RMS (12kHz to 20MHz offset)			1.0	1.8	ps	<i>See Note #2</i>

Note #1: Inclusive of initial tolerance at 25°C±3°C, operating temperature range, input voltage variation, load variation & 15 years aging at 25°C.

Note #2: The rms jitter integrated over 12kHz to 20MHz Bandwidth is dependent on the carrier and whether or not the final frequency is achieved without engaging the Fractional Mode



Programmable - High Performance SMD XO & VCXO (LVPECL Output)

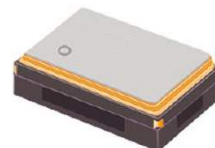

2.5 x 2.0 x 1.0 mm

ASG2-P



ESD Sensitive



RoHS / RoHS II Compliant

TEST CIRCUIT

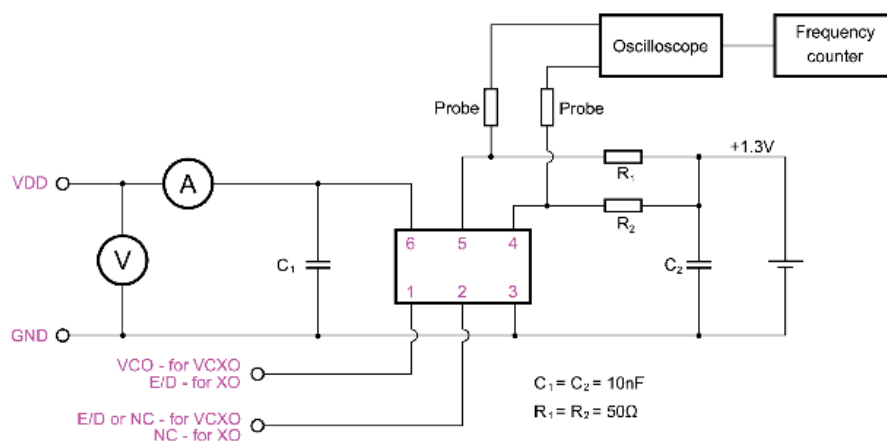

OPTIONS & PART IDENTIFICATION:

ASG2 - P - - - MHz -

Fixed or Pull-able
X = Fixed Oscillator
V = VCXO

Operating Voltage
3.30V = A
2.50V = B

Frequency in MHz
Please specify the Frequency in MHz e.g. 100.000 MHz

Packaging
Blank = Bulk
T = Tape & Reel

RECOMMENDED REFLOW PROFILE

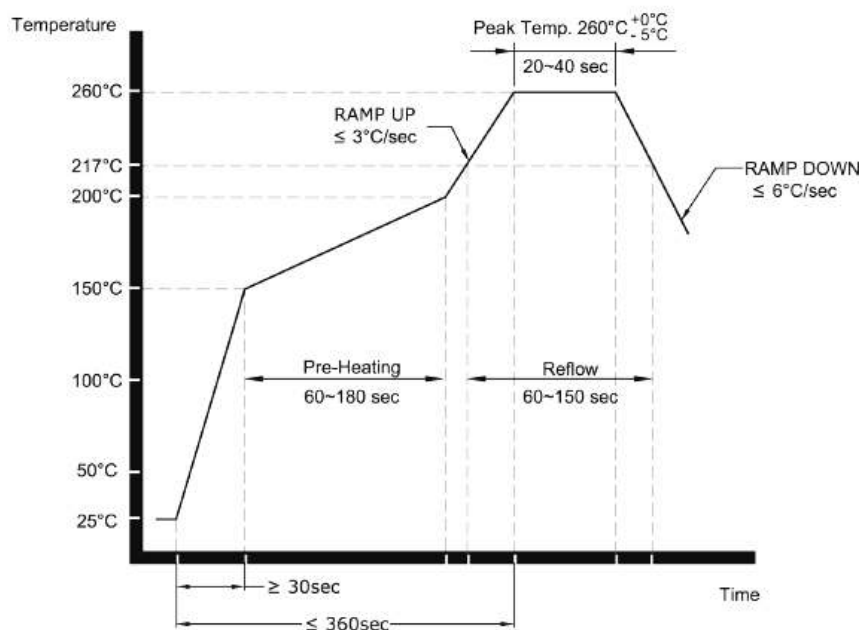

ABRACON IS
ISO9001:2008
CERTIFIED

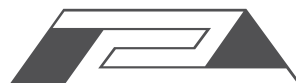

**ABRACON
CORPORATION**

Visit www.abracon.com for Terms & Conditions of Sale
30332 Esperanza, Rancho Santa Margarita, California 92688
tel 949-546-8000 | fax 949-546-8001 | www.abracon.com

Revised: 07.01.14

Programmable - High Performance SMD XO & VCXO (LVPECL Output)

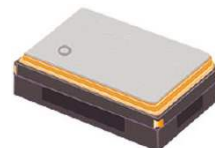

2.5 x 2.0 x 1.0 mm

ASG2-P

ESD Sensitive

RoHS / RoHS II Compliant

OUTLINE DIMENSION:

Pin #	Pin Description For VCXO configuration
1	Voltage Control for VCXO
2	Output Enable (OE) <i>or</i> No Connect (N/C)
3	GND
4	RF Output
5	Complimentary Output
6	Vdd

Pin #	Pin Description For XO configuration
1	Output Enable (OE)
2	No Connect (N/C) for XO
3	GND
4	RF Output
5	Complimentary Output
6	Vdd

Top View

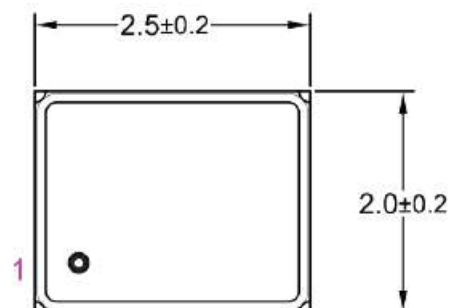

Bottom View

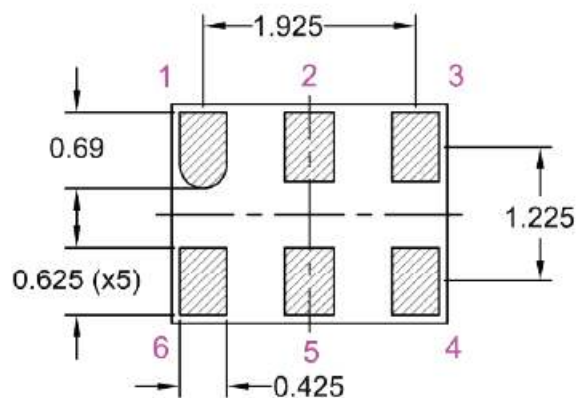

Recommended Land Pattern

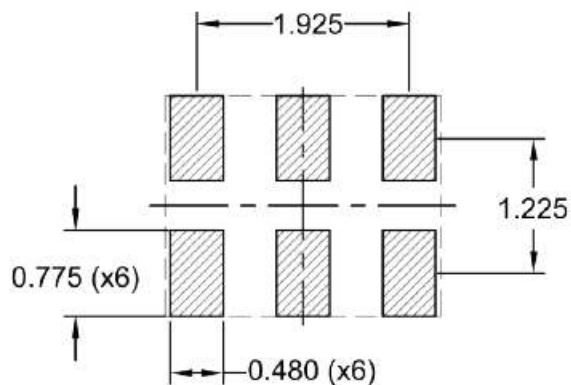

Side View



Dimensions: mm



