

927768-9 ✓ ACTIVE

AMP | Junior Power Timer

TE Internal #: 927768-9

Automotive Terminals, Receptacle, Mating Tab Width 2.8 mm [.11 in], Tab Thickness .8 mm [.031 in], 16 – 13 AWG Wire Size, Junior Power Timer

[View on TE.com >](#)



Terminals & Splices > Automotive Terminals > TIMER, RECEPTACLE AND TAB

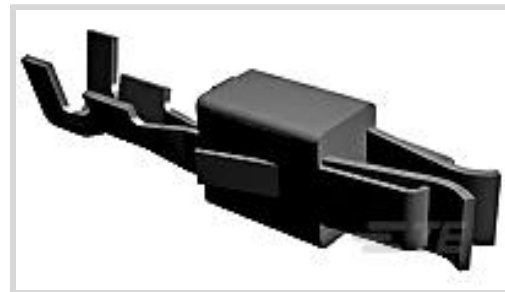

Terminal Type: **Receptacle**

Mating Tab Width: **2.8 mm [.11 in]**

Mating Tab Thickness: **.8 mm [.031 in]**

Terminal Transmits: **25 – 40 A (Power)**

Wire Size: **16 – 13 AWG**

[All TIMER, RECEPTACLE AND TAB \(348\)](#)

Features

Product Type Features

Receptacle Style	180°
Sealable	No
Primary Locking Feature	Locking Lance

Contact Features

Contact Size	2.8mm
Contact Fabrication	Stamped & Formed
Wire Contact Termination Area Plating Material	Tin
Typical Current Rating	30 A
Crimp Type	F-Crimp
Terminal Type	Receptacle
Mating Tab Width	2.8 mm [.11 in]
Mating Tab Thickness	.8 mm [.031 in]
Interface Plating	Tin (Sn)

Termination Features

Termination Method to Wire & Cable	Crimp
Product Terminates To	Wire

Dimensions



Compatible Insulation Diameter Range	2.1 – 3.1 mm [.083 – .122 in]
Wire Size	1.25 – 2.5 mm ²
Wire Size Search	13 AWG, 14 AWG, 15 AWG, 16 AWG

Usage Conditions

Insulation Option	Uninsulated
Operating Temperature (Max)	80 °C, 85 °C, 90 °C, 100 °C, 105 °C, 110 °C, 120 °C, 125 °C, 130 °C [176 °F][185 °F][194 °F][212 °F][221 °F][230 °F][248 °F][257 °F][266 °F]
Operating Temperature Range	-40 – 130 °C [-40 – 266 °F]

Operation/Application

Compatible With Wire Base Material	Copper
------------------------------------	--------

Industry Standards

Agency/Standard	DIN 72 551 Part 6, DIN ISO 6722 part 3, IEC 664/664A (DIN VDE 0110)
-----------------	---

Packaging Features

Packaging Quantity	3300
Packaging Method	Reel

Other

Terminal Transmits	25 – 40 A (Power)
--------------------	-------------------

Product Compliance

[For compliance documentation, visit the product page on TE.com>](#)

EU RoHS Directive 2011/65/EU	Compliant
EU ELV Directive 2000/53/EC	Compliant
China RoHS 2 Directive MIIT Order No 32, 2016	No Restricted Materials Above Threshold
EU REACH Regulation (EC) No. 1907/2006	Current ECHA Candidate List: JUNE 2023 (235) Candidate List Declared Against: JUNE 2023 (235) Does not contain REACH SVHC
Halogen Content	Low Halogen - Br, Cl, F, I < 900 ppm per homogenous material. Also BFR/CFR/PVC Free
Solder Process Capability	Not applicable for solder process capability

Product Compliance Disclaimer

This information is provided based on reasonable inquiry of our suppliers and represents our current actual knowledge based on the information they provided. This information is subject to change. The part numbers that TE has identified as EU RoHS compliant have a maximum concentration of 0.1% by weight in homogenous materials for lead, hexavalent chromium, mercury, PBB, PBDE, DBP, BBP, DEHP, DIBP, and 0.01% for cadmium, or qualify for an exemption to these limits as defined in the Annexes of Directive 2011/65/EU (RoHS2). Finished electrical and electronic equipment products will be CE marked as required by Directive 2011/65/EU. Components may not be CE marked. Additionally, the part numbers that TE has identified as EU ELV compliant have a maximum concentration of 0.1% by weight in homogenous materials for lead, hexavalent chromium, and mercury, and 0.01% for cadmium, or qualify for an exemption to these limits as defined in the Annexes of Directive 2000/53/EC (ELV). Regarding the REACH Regulation, the information TE provides on SVHC in articles for this part number is based on the latest European Chemicals Agency (ECHA) 'Guidance on requirements for substances in articles' posted at this URL: <https://echa.europa.eu/guidance-documents/guidance-on-reach>

Compatible Parts



TE Part # CAT-T4827-CH8172
Timer Connector Housing



TE Part # CAT-AM705-CH8173
AMP MCP Unsealed Connector Housings



TE Part # 4-1579007-3
EXTRACTION TOOL KIT



TE Part # 1-1579007-6
EXTRACTION TOOL



TE Part # 2305570-1
Strip Terminal Cutter-Side Feed-No Crimp



TE Part # 1-967625-3
JUN-POW-TIM GEH 21P



TE Part # 2-1579007-3
EXTRACTION TOOL



TE Part # 2-2151154-1
OCEAN_2.0_Applicator-S-110F140OV



TE Part # 2-2151154-2
OCEAN_2.0_Applicator-S-110F140OV



TE Part # 2151154-1
OCEAN_2.0_Applicator-S-110F140OV



TE Part # 2151154-2
OCEAN_2.0_Applicator-S-110F140OV



TE Part # 2392638-1
SDE F JR PWR TMR 1.5-2.5mm2 ASSY



TE Part # 2392638-2
SDE F JR PWR TMR 1.5-2.5mm2 DIE SET



TE Part # 5-2151154-1
OCEAN_2.0_Applicator-S-110F140OV



TE Part # 5-2151154-2
OCEAN_2.0_Applicator-S-110F140OV



TE Part # 7-2151154-1
OCEAN_2.0_Applicator-S-110F140OV



TE Part # 7-2151154-2
OCEAN_2.0_Applicator-S-110F140OV



KIT
REPRESENTATION ONLY

TE Part # 7-2151154-7
OCEAN_2.0_SPARE_PART_KIT-110F140OV



KIT
REPRESENTATION ONLY

TE Part # 7-2266187-7
OC-110F140OV-752-CRIMPTOOLINGKIT

TE Part # 2-967623-3
JUN-POW TIM GEH 15P

Also in the Series | Junior Power Timer



Automotive Connector Caps & Covers (5)



Automotive Housings(252)



Automotive Terminals(86)



Busbars & Terminals(1)



Connector Seals & Cavity Plugs(10)



Insertion & Extraction Tools(8)



Module Components(6)

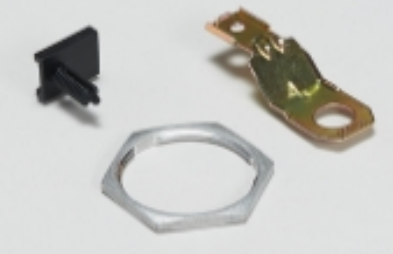

Other Automotive Connector Accessories(1)



PCB Headers & Receptacles(1)

Customers Also Bought

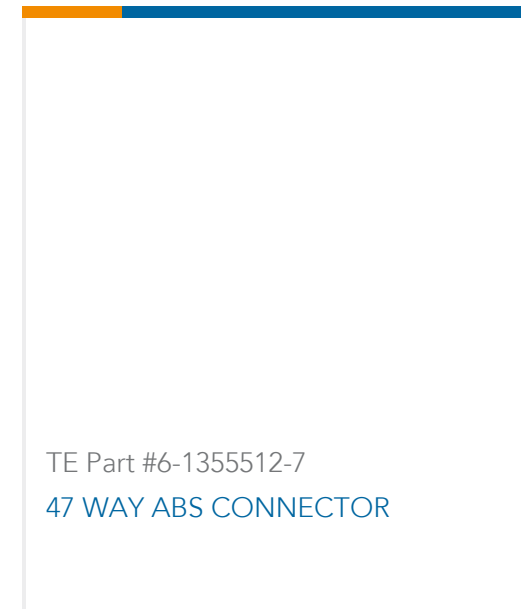
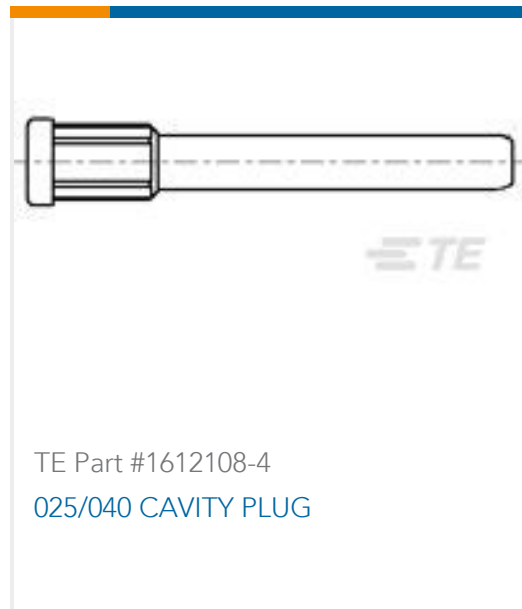
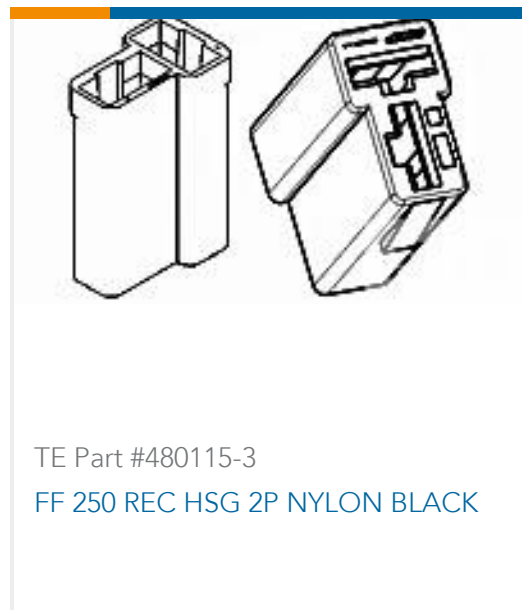

Documents

Product Drawings

[JPT REC 2.8 Contact SRC Au](#)

English

[JPT REC 2.8 Contact SRC Au](#)

English

CAD Files

Customer View Model

[ENG_CVM_927768-9_A9.3d_igs.zip](#)

English

Customer View Model

[ENG_CVM_927768-9_A9.3d_stp.zip](#)

English

Customer View Model

[ENG_CVM_927768-9_A9.2d_dxf.zip](#)

English

3D PDF

English



Datasheets & Catalog Pages

Timer Interconnection System

English

Product Specifications

Application Specification

German

Application Specification

English

Application Specification

English