

## QDD-200G-2Q28-04M-C

MSA and TAA Compliant 200GBase-AOC QSFP28-DD to 2xQSFP28 NRZ Active Optical Cable (850nm, MMF, 4m)

### Features

- Up to 25.78 Gbps per channel
- 2 independent full-duplex
- Single Power Supply: +3.3V
- Low-power consumption: 3.3W on QSFP28DD end, 1.65W on QSFP28 end
- Hot-pluggable QSFP-DD/QSFP28
- 4m with OM3 fibers
- Operating Temperature: 0°C to 70°C
- OFNP-rated cable
- TUV certified
- ROHS/Reach Compliant



### Applications

- 100Gigabit Ethernet
- InfiniBand EDR
- Datacenter
- Proprietary HPC interconnections

### Product Description

This is an MSA Compliant compatible 200GBase-AOC QSFP28-DD to 2xQSFP28 NRZ active optical cable that operates over active fiber with a maximum reach of 4m. At a wavelength of 850nm, it has been programmed, uniquely serialized, and data-traffic and application tested to ensure it is 100% compliant and functional. This NRZ active optical cable is TAA (Trade Agreements Act) compliant, and is built to comply with MSA (Multi-Source Agreement) standards. We stand behind the quality of our products and proudly offer a limited lifetime warranty.

ProLabs' active optical cables are RoHS compliant and lead-free.

TAA refers to the Trade Agreements Act (19 U.S.C. & 2501-2581), which is intended to foster fair and open international trade. TAA requires that the U.S. Government may acquire only "U.S. – made or designated country end products."



## General Specifications

Parameter	Symbol	Min.	Typ.	Max.	Unit	Notes
Storage Temperature	Tstg	-40		85	°C	1
Operating Case Temperature	Tc	0		70	°C	
Supply Voltage	Vcc	0		4	V	
Relative Humidity	RH	0		85	%	
Data Rate (Per Channel)	BR		35.78		Gbps	

### Notes:

1. Ambient temperature.

## Electrical Characteristics

Parameter	Symbol	Min.	Typ.	Max.	Unit	Notes
Power Supply Voltage	Vcc	3.13	3.3	3.47	V	
Power Supply Current	QSFP28-DD	Icc	1000		mA	Per End
	QSFP28	Icc	500		mA	Per End
Power Consumption	QSFP28-DD		3.3	3.47	W	Per End
	QSFP28		1.65	1.73	W	Per End
<b>Transmitter</b>						
Input Differential Impedance	RIN	90	100	110	Ω	
Differential Data Input Voltage	VIN,pp	200		900	mV	
<b>Receiver</b>						
Output Differential Impedance	ROUT	90	100	110		
Differential Data Output Voltage	VOUT,pp		800	mV		
Bit Error Ratio (At 25.78 Gbps)				10 <sup>-12</sup>		1

### Notes:

1. Pre-FEC Bit Error Ratio with a PRBS 2<sup>31</sup> – 1 test pattern.

## Cable Specifications

Parameter	Value	Unit	Notes
Cable Diameter	OFNP: $\varnothing 3.0 \pm 0.20$	mm	
Minimum Bend Radius	30	mm	1
	60	mm	2
Length Tolerance	+300 / -0	mm	
Cable Jacket	OFNP-Rated (Aqua)		

### Notes:

1. Without tension.
2. Under maximum tension.

## Pin Descriptions: QSFP28-DD End

Pin	Name	Name/Descriptions	Ref.
1	GND	Module Ground.	1
2	Tx2-	Transmitter Inverted Data Input.	
3	Tx2+	Transmitter Non-Inverted Data Input.	
4	GND	Module Ground.	1
5	Tx4-	Transmitter Inverted Data Input.	
6	Tx4+	Transmitter Non-Inverted Data Input.	
7	GND	Module Ground.	1
8	ModSelL	Module Select.	
9	ResetL	Module Reset.	
10	VccRx	+3.3V Power Supply Receiver.	2
11	SCL	2-Wire Serial Interface Clock.	
12	SDA	2-Wire Serial Interface Data.	
13	GND	Module Ground.	1
14	Rx3+	Receiver Non-Inverted Data Output.	
15	Rx3-	Receiver Inverted Data Output.	
16	GND	Module Ground.	1
17	Rx1+	Receiver Non-Inverted Data Output.	
18	Rx1-	Receiver Inverted Data Output.	
19	GND	Module Ground.	1
20	GND	Module Ground.	1
21	Rx2-	Receiver Inverted Data Output.	
22	Rx2+	Receiver Non-Inverted Data Output.	
23	GND	Module Ground.	1
24	Rx4-	Receiver Inverted Data Output.	

25	Rx4+	Receiver Non-Inverted Data Output.	
26	GND	Module Ground.	1
27	ModPrsL	Module Present.	
28	IntL	Interrupt.	
29	VccTx	+3.3V Power Supply Transmitter.	2
30	Vcc1	+3.3V Power Supply.	2
31	InitMode	Initialization Mode. In legacy QSPF applications, InitMode is listed as Low-Power Mode (LPMode).	
32	GND	Module Ground.	1
33	Tx3+	Transmitter Non-Inverted Data Input.	
34	Tx3-	Transmitter Inverted Data Input.	
35	GND	Module Ground.	1
36	Tx1+	Transmitter Non-Inverted Data Input.	
37	Tx1-	Transmitter Inverted Data Input.	
38	GND	Module Ground.	1
39	GND	Module Ground.	1
40	Tx6-	Transmitter Inverted Data Input.	
41	Tx6+	Transmitter Non-Inverted Data Input.	
42	GND	Module Ground.	1
43	Tx8-	Transmitter Inverted Data Input.	
44	Tx8+	Transmitter Non-Inverted Data Input.	
45	GND	Module Ground.	1
46	Reserved	For Future Use.	3
47	VS1	Module Vendor-Specific 1.	3
48	VccRx1	+3.3V Receiver Power Supply.	2
49	VS2	Module Vendor-Specific 2.	3
50	VS3	Module Vendor-Specific 3.	3
51	GND	Module Ground.	1
52	Rx7+	Receiver Non-Inverted Data Output.	
53	Rx7-	Receiver Inverted Data Output.	
54	GND	Module Ground.	1
55	Rx5+	Receiver Non-Inverted Data Output.	
56	Rx5-	Receiver Inverted Data Output.	
57	GND	Module Ground.	1
58	GND	Module Ground.	1
59	Rx6-	Receiver Inverted Data Output.	
60	Rx6+	Receiver Non-Inverted Data Output.	
61	GND	Module Ground.	1
62	Rx8-	Receiver Inverted Data Output.	
63	Rx8+	Receiver Non-Inverted Data Output.	

64	GND	Module Ground.	1
65	NC	Not Connected.	3
66	Reserved	For Future Use.	3
67	VccTx1	+3.3V Transmitter Power Supply.	2
68	Vcc2	+3.3V Power Supply.	2
69	ePPS	Precision Time Protocol (PTP) Reference Clock Input.	3
70	GND	Module Ground.	1
71	Tx7+	Transmitter Non-Inverted Data Input.	
72	Tx7-	Transmitter Inverted Data Input.	
73	GND	Module Ground.	1
74	Tx5+	Transmitter Non-Inverted Data Input.	
75	Tx5-	Transmitter Inverted Data Input.	
76	GND	Module Ground.	1

**Notes:**

1. GND is the symbol for signal and supply (power) common for the QSFP-DD module. All are common within the QSFP-DD module, and all module voltages are referenced to this potential unless otherwise noted.
2. VccRx, VccRx1, Vcc1, Vcc2, VccTx, and VccTx1 shall be applied concurrently. The connector pins are each rated for a maximum current of 1000mA.
3. All Vendor-Specific, Reserved, No Connect, and ePPS (if not used) pins may be terminated with 50Ω to ground on the host, and Pad 65 (No Connect) shall be left unconnected within the module.

**Electrical Pin-Out: QSFP28-DD**

**Top Side Viewed From Top**

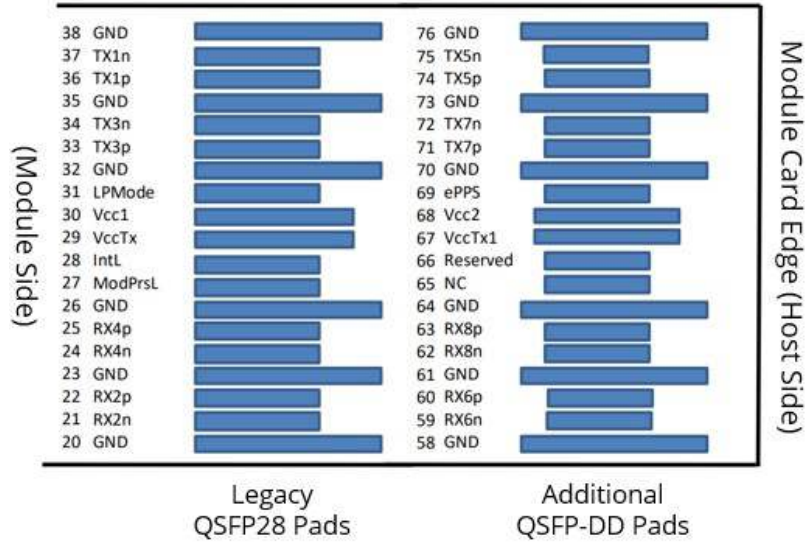

**Top Side Viewed From Bottom**

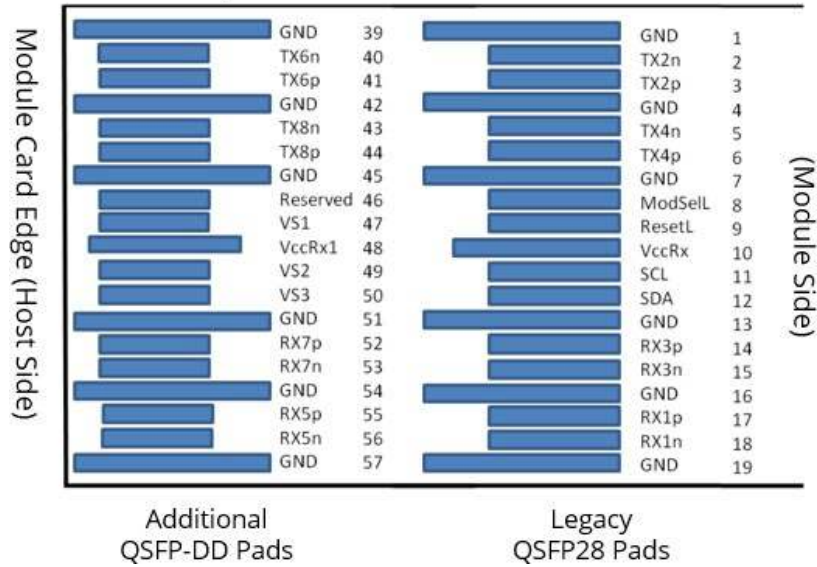

## Pin Descriptions: QSFP28 End

Pin	Name	Name/Descriptions	Ref.
1	GND	Module Ground.	1
2	Tx2-	Transmitter Inverted Data Input.	
3	Tx2+	Transmitter Non-Inverted Data Input.	
4	GND	Module Ground.	1
5	Tx4-	Transmitter Inverted Data Input.	
6	Tx4+	Transmitter Non-Inverted Data Input.	
7	GND	Module Ground.	1
8	ModSelL	Module Select.	
9	ResetL	Module Reset.	
10	VccRx	+3.3V Receiver Power Supply.	2
11	SCL	2-Wire Serial Interface Clock.	
12	SDA	2-Wire Serial Interface Data.	
13	GND	Module Ground.	1
14	Rx3+	Receiver Non-Inverted Data Output.	
15	Rx3-	Receiver Inverted Data Output.	
16	GND	Module Ground.	1
17	Rx1+	Receiver Non-Inverted Data Output.	
18	Rx1-	Receiver Inverted Data Output.	
19	GND	Module Ground.	1
20	GND	Module Ground.	1
21	Rx2-	Receiver Inverted Data Output.	
22	Rx2+	Receiver Non-Inverted Data Output.	
23	GND	Module Ground.	1
24	Rx4-	Receiver Inverted Data Output.	
25	Rx4+	Receiver Non-Inverted Data Output.	
26	GND	Module Ground.	1
27	ModPrsL	Module Present.	
28	IntL	Interrupt.	
29	VccTx	+3.3V Transmitter Power Supply.	2
30	Vcc1	+3.3V Power Supply.	2
31	LPMODE	Low-Power Mode.	3
32	GND	Module Ground.	1
33	Tx3+	Transmitter Non-Inverted Data Input.	
34	Tx3-	Transmitter Inverted Data Input.	

35	GND	Module Ground.	1
36	Tx1+	Transmitter Non-Inverted Data Input.	
37	Tx1-	Transmitter Inverted Data Input.	
38	GND	Module Ground.	1

**Notes:**

1. GND is the symbol for signal and supply (power) common for the QSFP module. All are common within the QSFP module, and all module voltages are referenced to this potential unless otherwise noted. Connect these directly to the host board signal-common ground plane.
2. VccRx, Vcc1, and VccTx are the receiver and transmitter power supplies and shall be applied concurrently. VccRx, Vcc1, and VccTx may be internally connected within the QSFP transceiver module in any combination. The connector pins are each rated for a maximum current of 500mA.
3. Not in use.

**Electrical Pin-Out: QSFP28**





**Mechanical Specifications: QSFP28-DD**

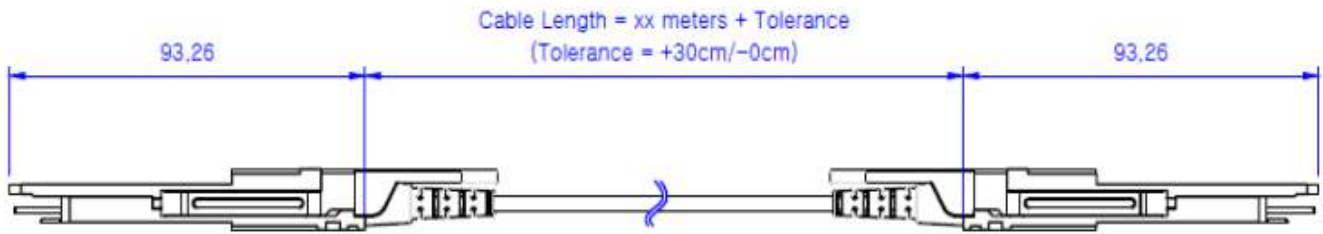
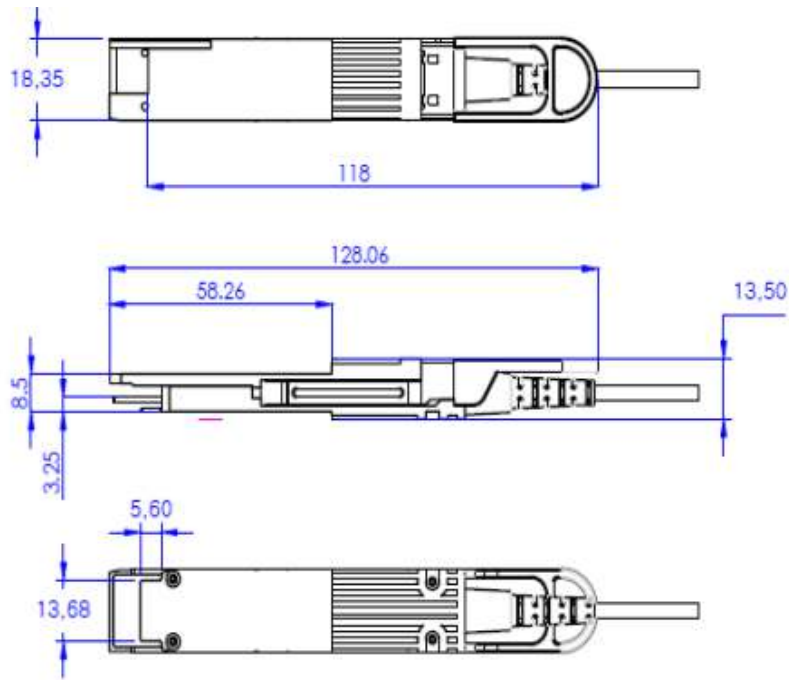

**Mechanical Specifications: QSFP28**

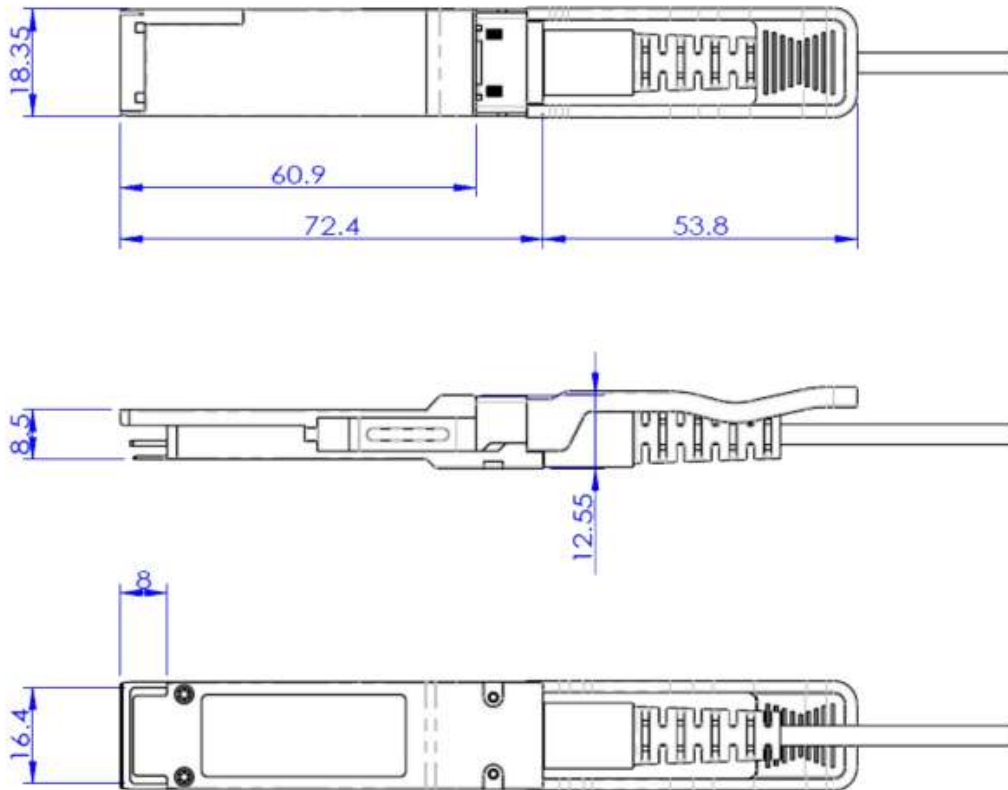

**Mechanical Specifications: QSFP28-DD to 2x QSFP28 Breakout**

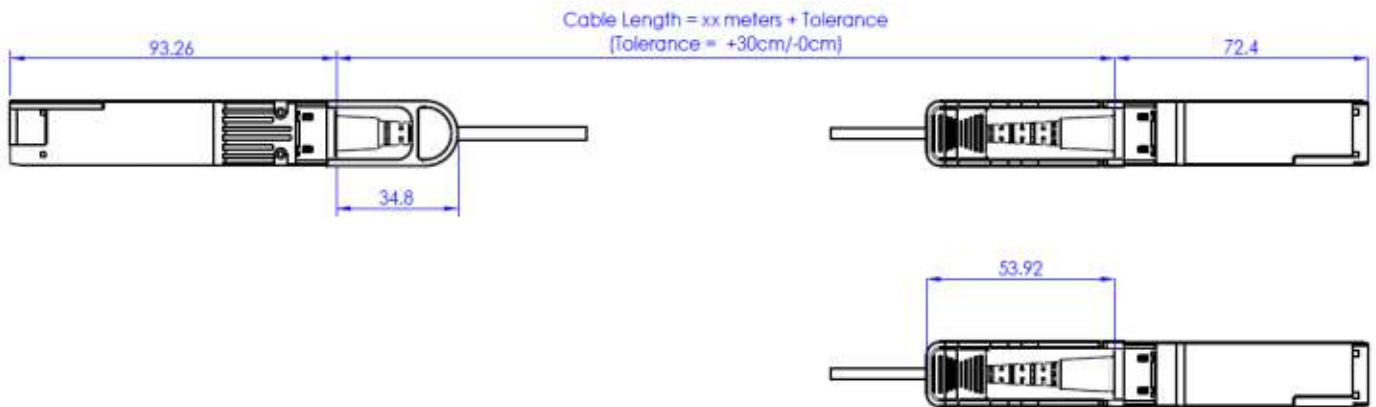

**About ProLabs**

Our experience comes as standard; for over 15 years ProLabs has delivered optical connectivity solutions that give our customers freedom and choice through our ability to provide seamless interoperability. At the heart of our company is the ability to provide state-of-the-art optical transport and connectivity solutions that are compatible with over 90 optical switching and transport platforms.

**Complete Portfolio of Network Solutions**

ProLabs is focused on innovations in optical transport and connectivity. The combination of our knowledge of optics and networking equipment enables ProLabs to be your single source for optical transport and connectivity solutions from 100Mb to 400G while providing innovative solutions that increase network efficiency. We provide the optical connectivity expertise that is compatible with and enhances your switching and transport equipment.

**Trusted Partner**

Customer service is our number one value. ProLabs has invested in people, labs and manufacturing capacity to ensure that you get immediate answers to your questions and compatible product when needed. With Engineering and Manufacturing offices in the U.K. and U.S. augmented by field offices throughout the U.S., U.K. and Asia, ProLabs is able to be our customers best advocate 24 hours a day.

**Contact Information**

ProLabs US

Email: [sales@prolabs.com](mailto:sales@prolabs.com)

Telephone: 952-852-0252

ProLabs UK

Email: [salessupport@prolabs.com](mailto:salessupport@prolabs.com)

Telephone: +44 1285 719 600