

TABLE 1: PART LIST

ITEM	QTY	DESCRIPTION	MATERIAL	FINISH
1	1	CABLE 2x0.75+ 10x0.34 TPU BK D8.8 TPE UNS	TPU	BLACK
2	1	OVERMOLD	PUR	BLACK
3	1	INSERT	PBT	BLACK
4	14	SOCKET CONTACT	COPPER ALLOY	GOLD
5	1	COUPLER	BRASS	PLATING WHITE BRONZE

TABLE 2: FINISHED PRODUCTS

ENG-NO.	MOLEX PN	DESCRIPTION	L +Tol. [mm]	GEOMETRY
L04A00B78M050	1300238025	M16 ST CON FOR M8 NANO BOX 5M - 10port	5000 +60	STR
L04A00B78M100	1300238026	M16 ST CON FOR M8 NANO BOX 10M - 10port	10000 +80	STR
L04A00B78M150	1300238027	M16 ST CON FOR M8 NANO BOX 15M - 10port	15000 +140	STR
L04A01B78M050	1300238028	M16 90° CON FOR M8 NANO BOX 5M - 10port	5000 +60	RA
L04A01B78M100	1300238029	M16 90° CON FOR M8 NANO BOX 10M - 10port	10000 +80	RA
L04A01B78M150	1300238030	M16 90° CON FOR M8 NANO BOX 15M - 10port	15000 +140	RA
L04A01B78M250	1300238031	M16 90° CON FOR M8 NANO BOX 25M - 10port	25000 +160	RA
L04A01B78M400	1300238032	M16 90° CON FOR M8 NANO BOX 40M - 10port	40000 +400	RA

TABLE 3: CABLE SPEC

CABLE TYPE	CABLE JACKET	UL	CSA	Temperature range (static) (Bending radius up to 7.5xD)	Temperature range (flexing) (Bending radius up to 12.5xD)	drag chain tested	other
B78-12	TPU black	STYLE 21215	yes	-40°C to +90°C	-25°C to +80°C	5 Mio cycles	WELD SLAG RESISTANCE

WIRING SCHEMATIC:

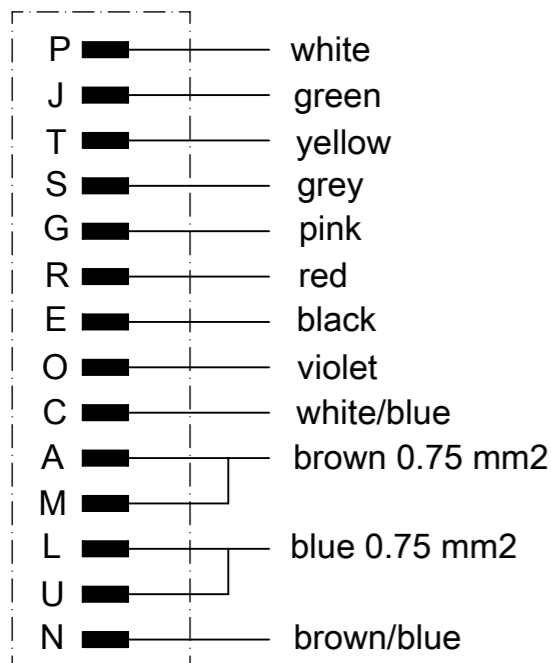

1. MATERIALS : SEE TABLE 1
2. FINISHES: SEE TABLE 1
3. ELECTRICAL DATA:  
MAX. VOLTAGE RATING 60 VAC  
MAX. CURRENT 3 AMPS
4. ENVIRONMENTAL: PROTECTION IP67  
TEMPERATURE RANGE -30°C TO +80°C
5. ASSEMBLY IS RoHS COMPLIANT

GEOMETRY STR  
(STRAIGHT)

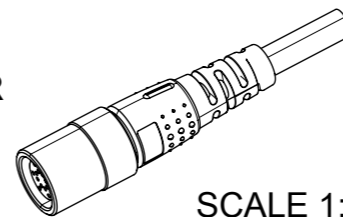

SCALE 1:2

GEOMETRY RA  
(RIGHT ANGLE)

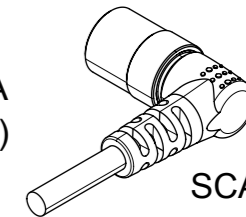

SCALE 1:2

FACE VIEW  
SEE DETAIL A

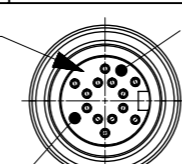

M16 x 0.75  
INTERNAL THREAD

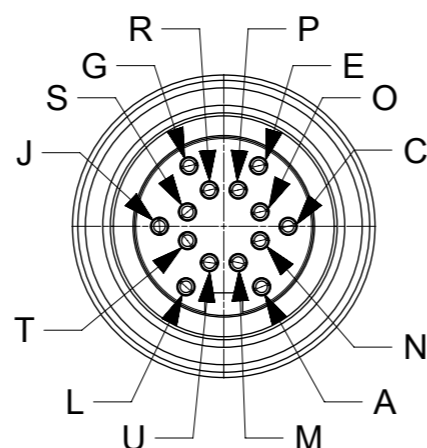

M16 FEMALE FACE VIEW  
SCALE 2:1

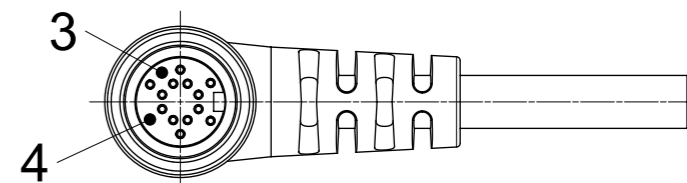
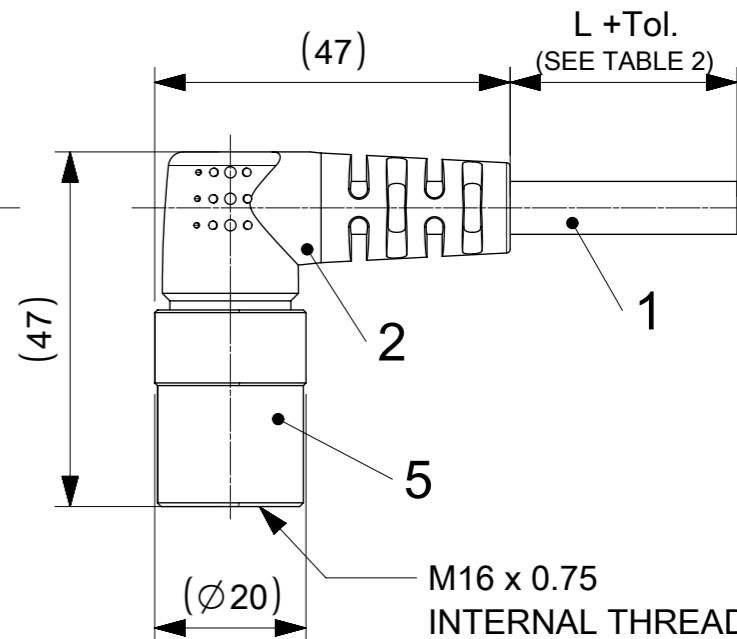
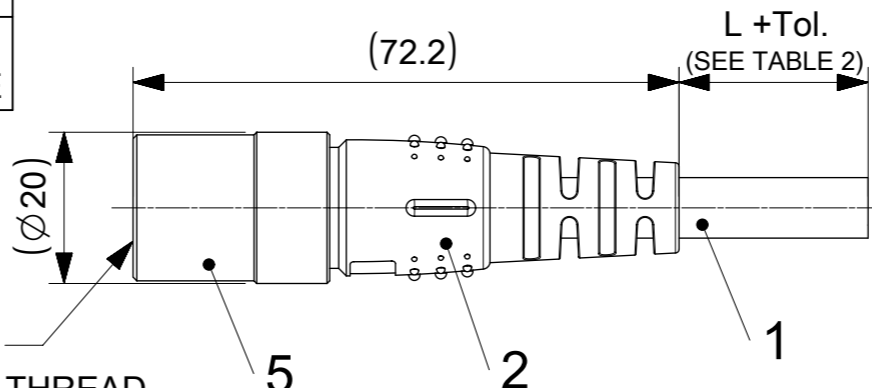

SYMBOLS	THIS DRAWING CONTAINS INFORMATION THAT IS PROPRIETARY TO MOLEX ELECTRONIC TECHNOLOGIES, LLC AND SHOULD NOT BE USED WITHOUT WRITTEN PERMISSION						
	DIMENSION UNITS	SCALE				CURRENT REV DESC: KNURLED PART ON SLEEVE POS. CHANGED FOR BETTER HANDLING	DOCUMENT NUMBER
▽ = 0	mm	1:1	EC NO: 623693	1300238025	PSD	000	B
▽ = 0	GENERAL TOLERANCES (UNLESS SPECIFIED)		DRWN: SSM 2019/08/27	CSE M16 14P 10PT AC FE RA+STR TPU SE XM UNSH BK			
▽ = 0	ANGULAR TOL ± 1.0°		CHK'D: RSILLER 2019/09/26	PRODUCT CUSTOMER DRAWING			
▽ = 0	4 PLACES ±		APPR: RSILLER 2019/09/26	INITIAL REVISION:			
▽ = 0	3 PLACES ±		DRWN: MSCHAUER 2015/01/27		MATERIAL NUMBER		
▽ = 0	2 PLACES ± 0.05		APPR: CBURGER 2015/02/06		CUSTOMER		
▽ = 0	1 PLACE ± 0.3		DRAWING		SHEET NUMBER		
▽ = 0	0 PLACES ± 0.5		SERIES		GENERAL MARKET		
■ = 0	DRAFT WHERE APPLICABLE MUST REMAIN WITHIN DIMENSIONS		THIRD ANGLE PROJECTION		SEE TABLE 2		
▽ = 0			DRAWING		1 OF 1		
		A3-SIZE		130023			