

# TMS 3450NL – LED DUPLEX DIGITAL RADIO CLOCK

- Duplex LED DISPLAY DRIVE
- 50/60 Hz operation
- 12/24 hour display mode
- AM/PM outputs (12 hour mode)
- Hour and min auto set controls with one touch incrementer
- 9 minute snooze
- Power fail indication
- Leading zero blanking
- Presettable 59 min. or 1 hour 59 min. sleep timer
- 24 hour alarm setting
- On-chip CR back-up oscillator
- 900 Hz tone output
- 28 Pins 400 mil package

## Description

The TMS 3450NL is a 4 digit radio clock LSI utilizing the MOS P-channel low threshold, ion-implanted depletion load technology. The single 28 pin dual-in line plastic package provides the functions required for the radio clock, the alarm/table clock and the other timer applications. The features are as follows:—

## Operation

A block diagram of the TMS3450NL digital radio clock circuit is shown Figure 1. The various display modes and the functions of the setting controls are summarized in Table 1 and 2. respectively.

- 50/60 Hz input: An on-chip schmitt trigger circuit allows a simple RC filter at the input to remove possible line voltage transients. Internal pull up resistor is provided.
- CR input: When power down is occurred, the time counter will be on "HOLD" state and on-chip clock oscillator will operate immediately. If there is no input at "50/60 Hz Input" during 3 clock periods, this oscillator controls the time counter advances instead of "50/60 Hz input".

The values of C & R determine the frequency of on-chip clock oscillator. All segment outputs except colon-out are off during back-up oscillator operation.

Note:- If back-up OSC is used at power down state, 50/60 Hz input must be open or  $V_{ss}$  level at power down state.

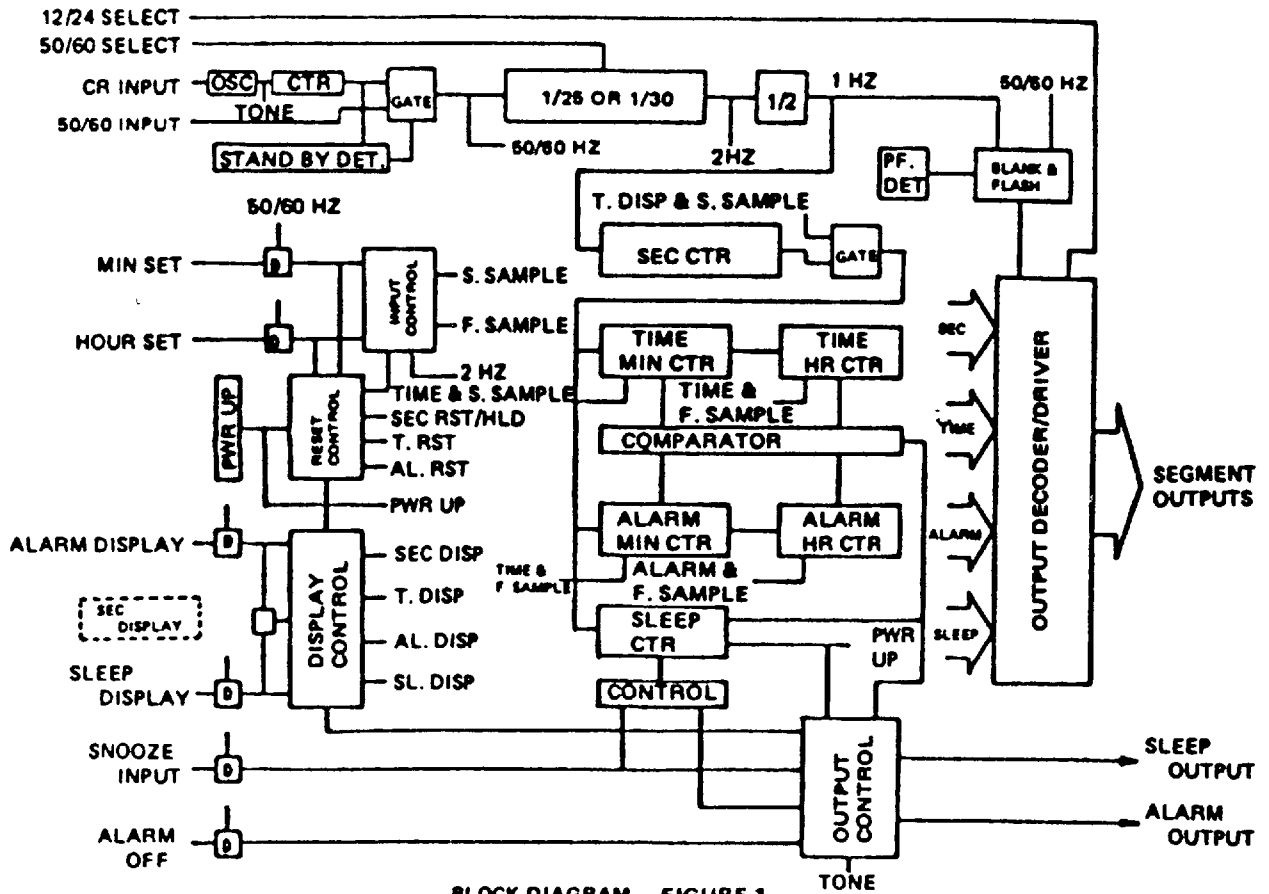

- Alarm operation and output: The coincidence between the alarm counter and the time counter enables the alarm output signal, which continues for 1:59 unless it's reset by the snooze input or by the alarm-off input. This output is provided for the tone signal of 900 Hz with 50% duty of 2 Hz gated signal, which keeps normally high level during alarm-on. This alarm signal will allow easily to get a DC signal by simple LPF if it's required.
- Snooze input: On alarm on-state momentarily connecting to  $V_{SS}$  inhibits the alarm output for 8 and 9 minutes, after which the alarm signal is enabled again. The snooze alarm feature may be repeatedly used during the 1 hour 59 minutes. This input is pull-down to  $V_{DD}$  by an internal resistor. On alarm off-state, this causes the sleep counter to reset to 0:00.
- Alarm-off input: Momentarily connecting alarm off input to  $V_{SS}$  resets the alarm output. This input is also returned to  $V_{DD}$  by an internal resistor.
- Sleep timer and output: The sleep output can be used to turn-off a radio after a desired time interval of 59 minutes or 1 hour 59 minutes. Selection method (59 minutes or 1 hour 59 minutes) is shown on Table 2. The presetting of time interval results in the sleep output current drive which can be used to turn on a radio. When the sleep counter, which counts downwards, reaches 00 minutes the sleep output current drive is removed and the radio is turned off. This turn-off may also be manually controlled (at any time in the countdown) by the snooze input.

## ELECTRICAL SPECIFICATION FOR TMS3450NL LED DUPLEX CLOCK

### I. Absolute maximum ratings over operating free-air temperature range (unless otherwise noted)

Voltage applied at any pin	+0.3 to -15.0V
Operating temperature	-20°C to +70°C
Storage temperature	-55°C to +150°C

- Stresses beyond those listed under "Absolute Maximum Ratings" may cause permanent damage to the device. This is a stress rating only and functional operation of the device at these or any other conditions beyond those indicated in the "Recommended Operating Conditions" section of this specification is not implied. Exposure to absolute-maximum-rated conditions for extended periods may affect device reliability.

### II. Recommended Operating Conditions

PARAMETER	MIN	TYP	MAX	UNITS
Power Supply Voltage	-7.5		-14	V
50/60 Hz Input				
Logical High Level	$V_{SS}-1$		$V_{SS}$	V
Logical Low Level	$V_{DD}$		$V_{DD}+2$	V
CR Input				
Logical High Level	$V_{SS}-1$		$V_{SS}$	V
Logical Low Level	$V_{DD}$		$V_{DD}+2$	V
All Other Input Voltage				
Logical High Level	$V_{SS}-1.5$		$V_{SS}$	V
Logical Low Level	$V_{DD}$		$V_{DD}+2$	V
Operating Free-air Temperature	-20		70	°C

### III. Electrical Characteristics Over Operating Free-air Temperature Range ( $V_{DD} = -12V$ )

PARAMETER	TEST CONDITIONS	MIN	TYP	MAX	UNITS
- Power Supply Current $I_{DD}$	No output loads		5.0	7.0	mA
- Power Failure Detect Voltage			-5.0	-7.5	V
- 50/60 Hz Frequency		DC	50 or 60	10K	Hz
Input Current	$V_{IH} = V_{SS}$ (Leakage) $V_{IL} = V_{DD}$			10 10	$\mu A$ $\mu A$
- All Other Inputs Input Current	$V_{IH} = V_{SS}$ $V_{IL} = V_{DD}$ (Leakage)			20 10	$\mu A$ $\mu A$

- Output Current 10's HR ag & da at 24 HR mode	$V_{OH} = V_{SS} - 1.0V$ $V_{OL} = V_{DD}$ (Leakage)	36	20	mA uA
- All Other Segment Output	$V_{OH} = V_{SS} - 1.0V$ $V_{OL} = V_{DD}$ (Leakage)	18	20	mA uA
- Alarm/Sleep output	$V_{OH} = V_{SS} - 1.0V$ $V_{OL} = V_{DD}$ (Leakage)	5	10	mA uA
- Back-up Oscillator Stability Accuracy Frequency	$V_{DD} = -9V \pm 10\%$ $V_{DD} = -9V$		$\pm 10$ $\pm 10$	% %
		900		Hz

- LED PANEL SOURCES
- SL-1498T (SANYO)
  - TLR-6242 (TOSHIBA)
  - LT-637 (TAIWAN LITON)

CHARACTERIZATION DATA OF TMS3460NL LED DUPLEX CLOCK

1. POWER SUPPLY & POWER FAIL VOLTAGE (25°C)

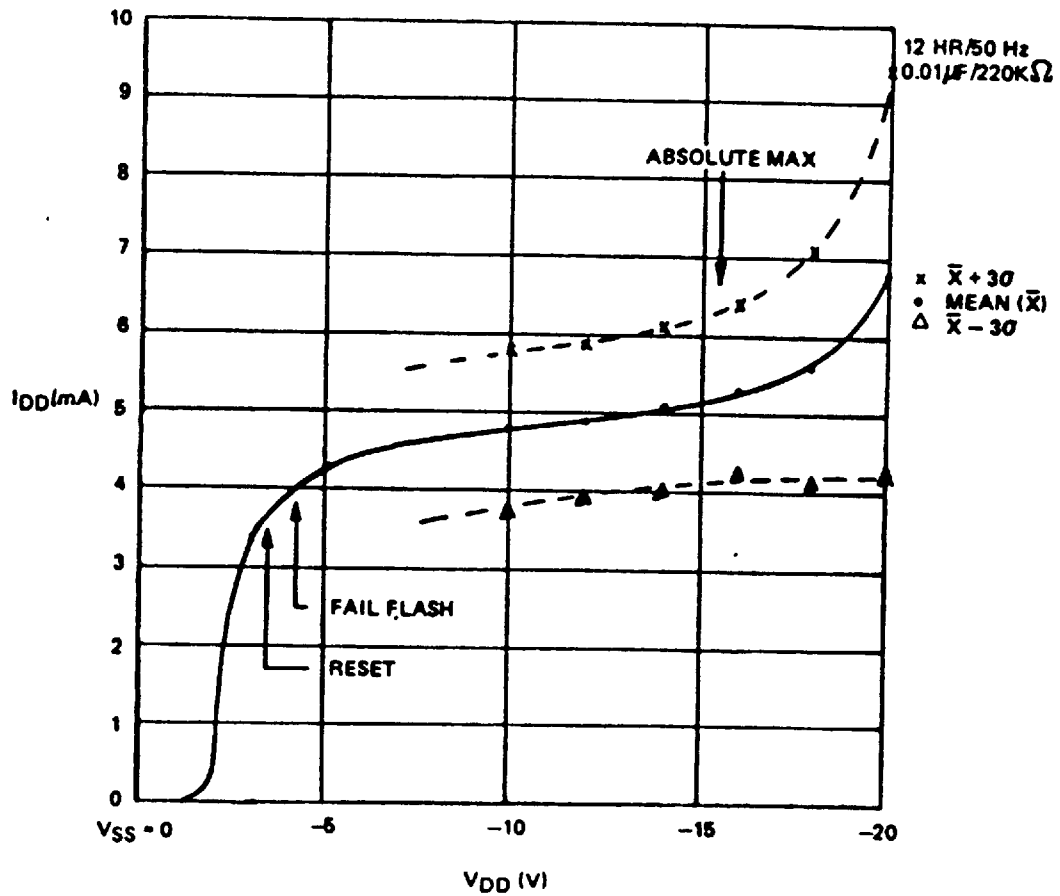

	RESET VOLTAGE $V_{DD}$	FAIL FLASH $V_{DD}$
$\bar{X} + 30$	-3.8V	-4.6V
$\bar{X}$	-3.4V	-4.2V
$\bar{X} - 30$	-3.1V	-3.7V

- 50/60 select input. Connecting 50/60 Hz select to  $V_{SS}$  enables 50 Hz operation. For 60 Hz operation the input is left unconnected. Pull-down to  $V_{DD}$  is provided by an internal resistor.
- Display mode select inputs. Internal pull-down resistor allows use of simple SPST switch to select four display modes.

DISPLAY MODES – TABLE 1

SELECT INPUT		DISPLAY MODE	DIGIT NO. 1	DIGIT NO. 2	DIGIT NO. 3	DIGIT NO. 4
ALARM	SLEEP					
N.C	N.C	TIME DISPLAY	10'S HOURS & AM/PM	HOURS	10'S MINUTES	MINUTES
$V_{SS}$	N.C	ALARM DISPLAY	10'S HOURS & AM/PM	HOURS	10'S MINUTES	MINUTES
N.C	$V_{SS}$	SLEEP DISPLAY	BLANKED	HOUR	10'S MINUTES	MINUTES
$V_{SS}$	$V_{SS}$	SECOND DISPLAY	BLANKED	MINUTES	10'S SECONDS	SECONDS

- At the selection of second display, it selects the both inputs of alarm and sleep with same time.
- Time setting inputs: Both hour and min inputs are provided and the application of  $V_{SS}$  effects the control functions listed in Table 2. Internal pull-down resistors are provided again.

SETTING CONTROL TABLE 2

DISPLAY MODE	SET INPUT	FUNCTION
TIME	HOUR	HOUR COUNTER +1 IMMEDIATELY, AND AFTER 1/4-3/4 SEC HOUR ADVANCE AT 2 Hz RATE.
	MIN	MINUTE COUNTER +1 IMMEDIATELY, AND AFTER 1/4-3/4 SEC MINUTES ADVANCE AT 2 Hz RATE. RESET SEC COUNTER.
	BOTH	(HAS BOTH ABOVE FUNCTION)
SEC ALARM & SLEEP	HOUR MIN BOTH*	SECONDS AND 10'S SECONDS RESET TO ZERO HOLD STATE RESET TIME COUNTER TO 0:00 (24 HR MODE) OR 12:00 AM (12 HR MODE)
ALARM	HOUR	ALARM HOUR COUNTER +1 IMMEDIATELY, AND AFTER 1/4-3/4 SEC ALARM HOURS ADVANCE AT 2 Hz RATE
	MIN	ALARM MINUTE COUNTER +1 IMMEDIATELY, AND AFTER 1/4-3/4 SEC ALARM MINUTES ADVANCE AT 2 Hz RATE
	BOTH*	RESET ALARM COUNTER TO 0:00 (24 HR MODE) OR 12:00 AM (12 HR MODE)
SLEEP	-	POSITIVE EDGE SETS SLEEP COUNTER TO 0:59
	HOUR	POSITIVE EDGE SETS SLEEP COUNTER TO 1:59
	MIN	SUBTRACT SLEEP COUNTER AT 2 Hz RATE
	BOTH	SUBTRACT SLEEP COUNTER AT 2 Hz RATE

- Once RESET/HLD functions are occurred, another function input is locked until both HOUR and MIN inputs are released.

Note: SECONDS and 10'S SECONDS are reset to zero and carry to MINUTES during SECONDS counter is 30 to 59.

- 12/24 hour select input: By leaving this pin unconnected the outputs are programmed for a 12 hour display format, and connecting to  $V_{SS}$  programs the 24 hour display format. An internal resistor is again provided.
- Power fail indication: If the power supply voltage drops, a power fail indication is provided by the flashing of the all on-segments. The power fail indication is reset by a hour or min set input.

2. I<sub>DD</sub> CURRENT (25°C)

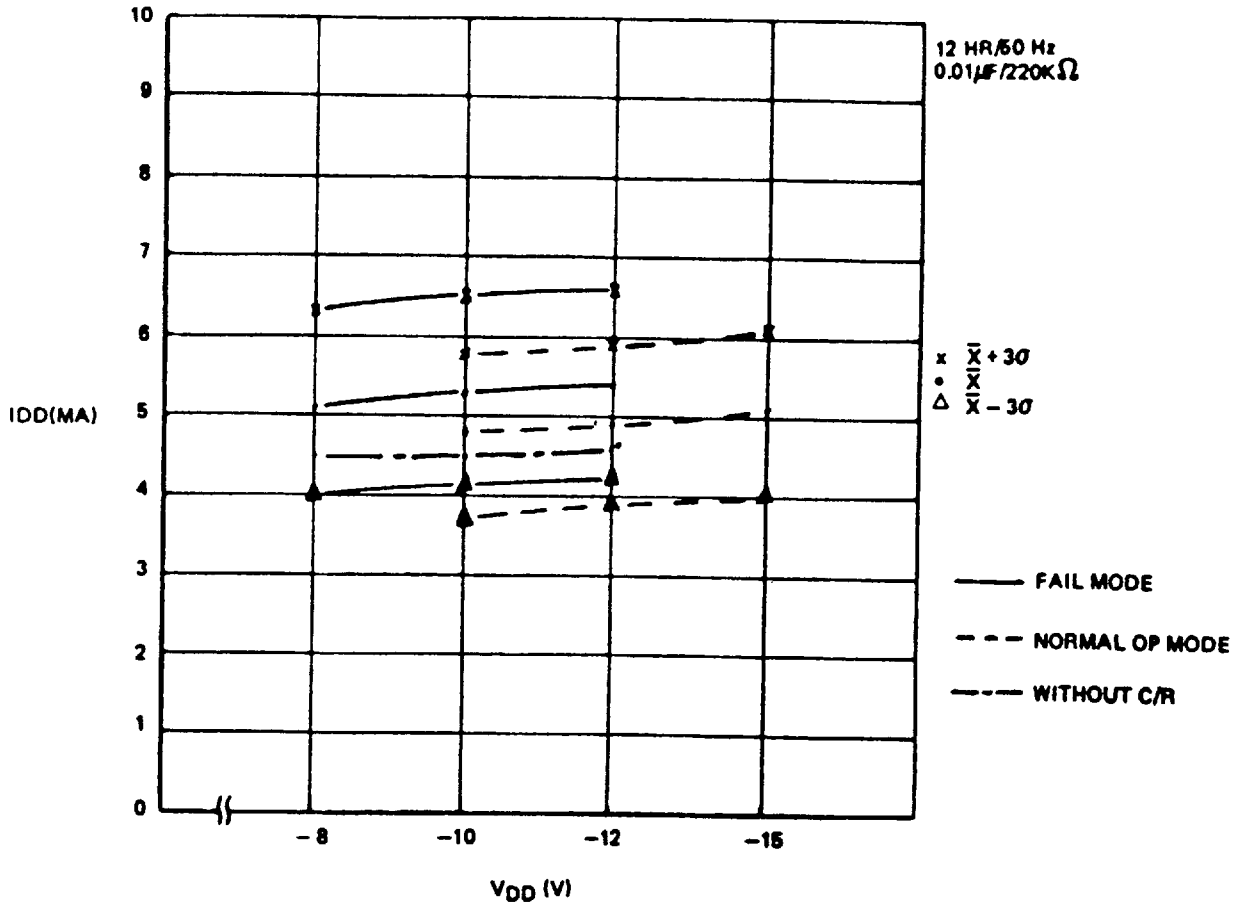

I <sub>DD</sub>	WITHOUT C/R			FAIL MODE			NORMAL OP MODE		
	V <sub>DD</sub> = -8	-10	-12	-8	-10	-12	-10	-12	-14 V
$\bar{X} + 3\sigma$	5.5	5.6	5.7	6.3	6.5	6.6	5.8	5.9	6.1 mA
$\bar{X}$	4.5	4.5	4.6	5.1	5.3	5.4	4.8	4.9	5.1 mA
$\bar{X} - 3\sigma$	3.5	3.5	3.6	4.0	4.1	4.2	3.7	3.9	4.0 mA

3. INPUTS CURRENT (I<sub>IH</sub>) & LEVEL (V<sub>IH</sub>, V<sub>IL</sub>) (25°C)

V<sub>DD</sub> = -12V  
0.01μF/22KΩ

	18 AL OFF	19 ALARM	21 MIN	22 HR	23 SLEEP	24 SNOOZE	25 50/60IN	26 50/60SEL	28 12/24SEL
I <sub>IH</sub> $\bar{X} + 3\sigma$	15.6	15.7	16.1	15.9	15.9	15.6		15.1	15.5 μA
$\bar{X}$	12.5	12.5	12.7	12.7	12.7	12.5	0	12.4	12.8 μA
$\bar{X} - 3\sigma$	9.3	9.3	9.3	9.6	9.4	9.4		9.7	10.1 μA
V <sub>IH</sub> $\bar{X} + 3\sigma$	-2.93	-2.94	-3.00	-2.97	-3.01	-3.12	-2.26	-3.04	-2.80 V
$\bar{X}$	-2.68	-2.69	-2.74	-2.71	-2.68	-2.84	-2.08	-2.79	-2.64 V
$\bar{X} - 3\sigma$	-2.42	-2.43	-2.48	-2.44	-2.36	-2.56	-1.89	-2.54	-2.39 V
V <sub>IL</sub> $\bar{X} + 3\sigma$		-3.13	-3.08	-3.13	-3.04		-2.92		-2.97 V
$\bar{X}$		-2.86	-2.80	-2.82	-2.79		-2.70		-2.71 V
$\bar{X} - 3\sigma$		-2.58	-2.53	-2.52	-2.55		-2.48		-2.46 V

4. CR INPUT CURRENT, VIH & VIL (25°C)

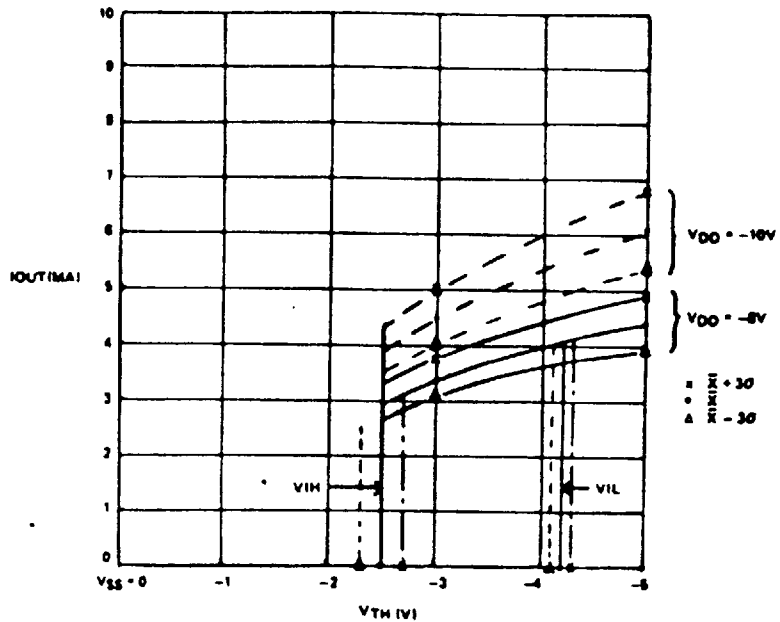

	VIH		VIL	
VDD =	-8	-10	-8	-10 V
$\bar{X} + 3\sigma$	-2.7	-2.7	-4.3	-5.2 V
$\bar{X}$	-2.5	-2.5	-4.2	-5.0 V
$\bar{X} - 3\sigma$	-2.3	-2.3	-4.1	-4.9 V

5. BACK-UP OSC C/R VS FREQUENCY VS VDD (25°C)

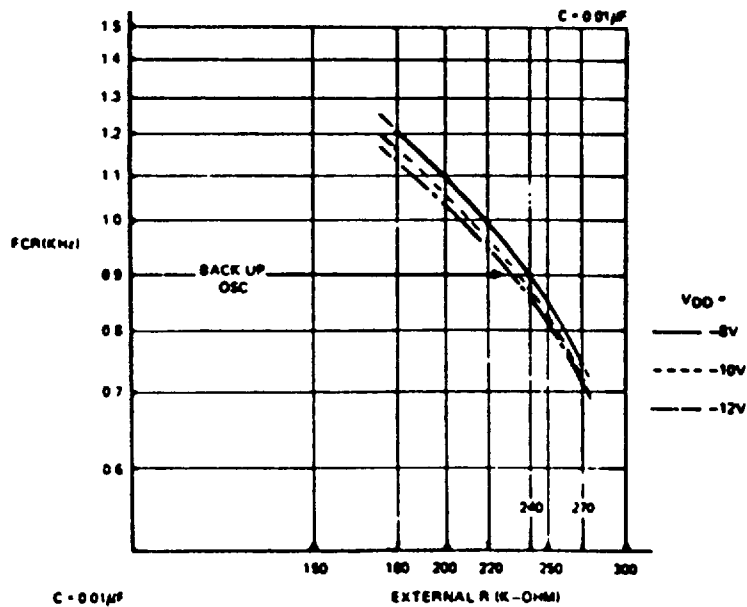

R =	180KΩ			220KΩ			240KΩ			270KΩ		
VDD =	-8	-10	-12	-8	-10	-12	-8	-10	-12	-8	-10	-12 V
$\bar{X} + 3\sigma$	1228	1176	1150	1004	970	954	916	890	877	761	744	736 Hz
$\bar{X}$	1204	1161	1138	986	957	943	899	876	864	744	731	725 Hz
$\bar{X} - 3\sigma$	1180	1145	1125	968	945	931	882	862	852	727	718	714 Hz

6. 50/80Hz INPUT CURRENT & BREAK-DOWN VOLTAGE (25°C)

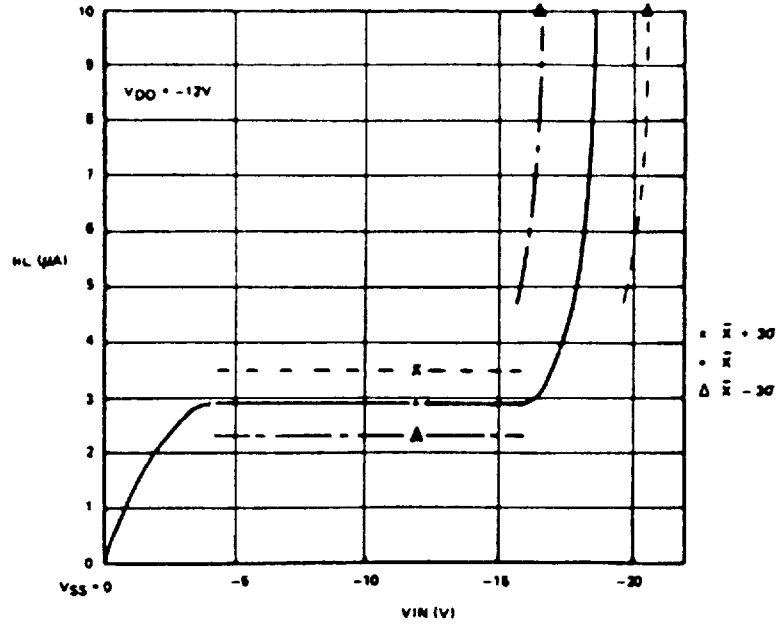

$I_{OUT} = 10\mu A$

	$V_{IL} = -12V$	BREAK DOWN VOLTAGE
$\bar{X} + 3\sigma$	3.5 $\mu A$	20.6 V
$\bar{X}$	2.9 $\mu A$	18.5 V
$\bar{X} - 3\sigma$	2.3 $\mu A$	16.5 V

7. ALARM & SLEEP OUTPUTS CURRENT VS  $V_{OH}$  VS  $V_{DD}$  (25°C)

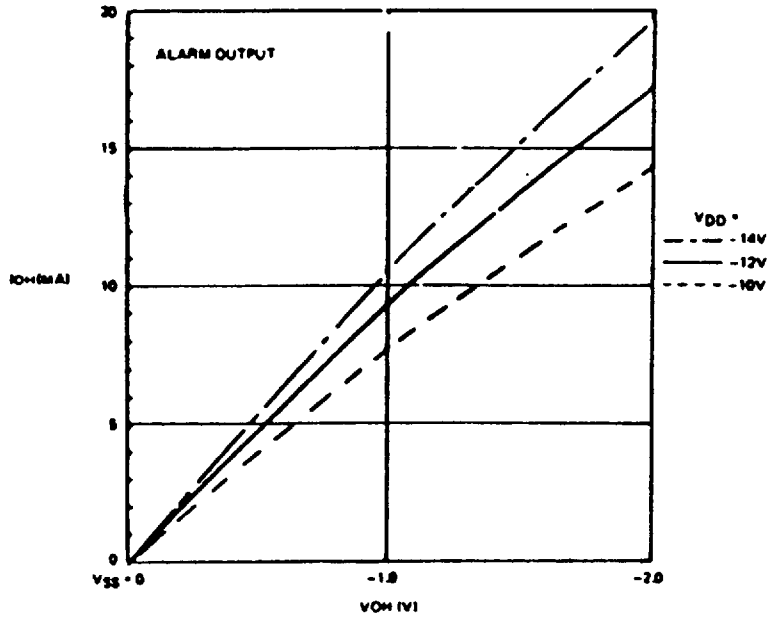

$V_{OH} = -1V$

$V_{DD}$	$I_{OH}$ (ALARM)			$I_{OH}$ (SLEEP)		
	-10	-12	-14	-10	-12	-14
$\bar{X} + 3\sigma$	8.8	10.0	11.8	10.3	12.3	13.7
$\bar{X}$	7.8	9.3	10.5	9.3	11.1	12.4
$\bar{X} - 3\sigma$	6.8	8.4	9.1	8.2	9.9	11.1

8. ALL SEGMENT OUTPUTS CURRENT ( $I_{OH}$ ) & BREAK-DOWN VOLTAGE (25°C)

$I_{OH}$   $V_{DD} = -12V$   
 $V_{OH} = -1.0V$

PIN #	1 AM	2 PM	3 HR E	4 HR BG	5 HR CD	6 HR AF	7 10'S M AF
$\bar{X} + 3\sigma$	29.5	25.7	25.6	26.3	26.4	26.4	26.5 mA
$\bar{X}$	27.1	23.7	23.6	24.3	24.2	24.2	24.1 mA
$\bar{X} - 3\sigma$	24.7	21.7	21.5	22.2	22.1	22.0	21.6 mA
	8 10'S M BG	9 10'S M CD	10 ME	11 M BG	12 M CD	13 M AF	14 COLON
$\bar{X} + 3\sigma$	26.6	26.6	26.6	26.6	24.8	27.4	26.9 mA
$\bar{X}$	24.2	24.2	24.2	24.3	22.4	24.2	24.2 mA
$\bar{X} - 3\sigma$	21.8	21.8	21.8	21.9	20.1	20.9	21.4 mA

BREAK-DOWN VOLTAGE

$V_{DD} = -12V$   
 $V_{OUT} = 10\mu A$

PIN #	1	8	12	16 (AL)	17 (SL)
$\bar{X} + 3\sigma$	21.4	26.9	26.7	27.8	27.3 V
$\bar{X}$	19.2	26.1	26.0	26.4	26.3 V
$\bar{X} - 3\sigma$	16.9	25.2	25.3	24.9	25.3 V

9. SEGMENT OUTPUT CURRENT VS  $V_{OH}$  VS  $V_{DD}$  (1) (25°C)

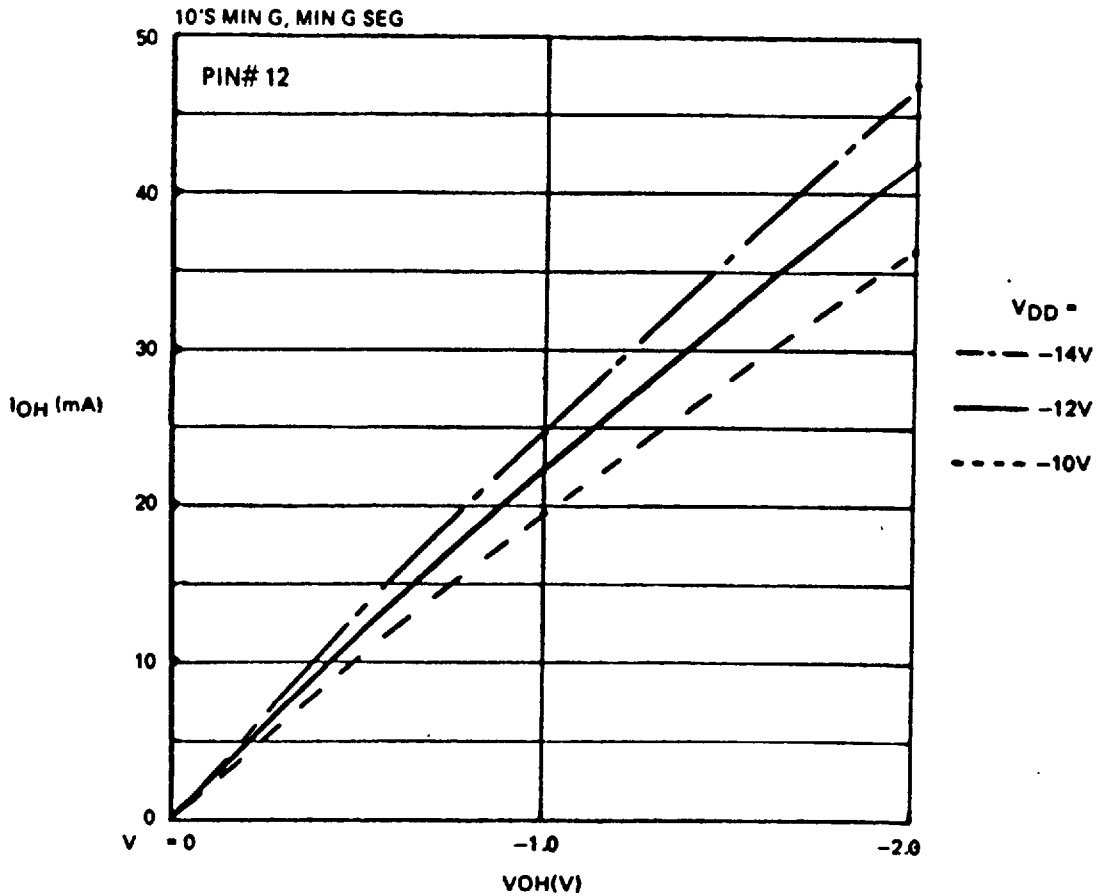

$V_{OH} = -1V$

$V_{DD} =$	-10	-12	-14	V
$\bar{X} + 3\sigma$	21.5	24.8	27.7	mA
$\bar{X}$	19.6	22.4	24.7	mA
$\bar{X} - 3\sigma$	17.7	20.1	21.7	mA



10 SEGMENT OUTPUT CURRENT VS VOH VS VDD (2) (25°C)

10'S HR A DEG SEG

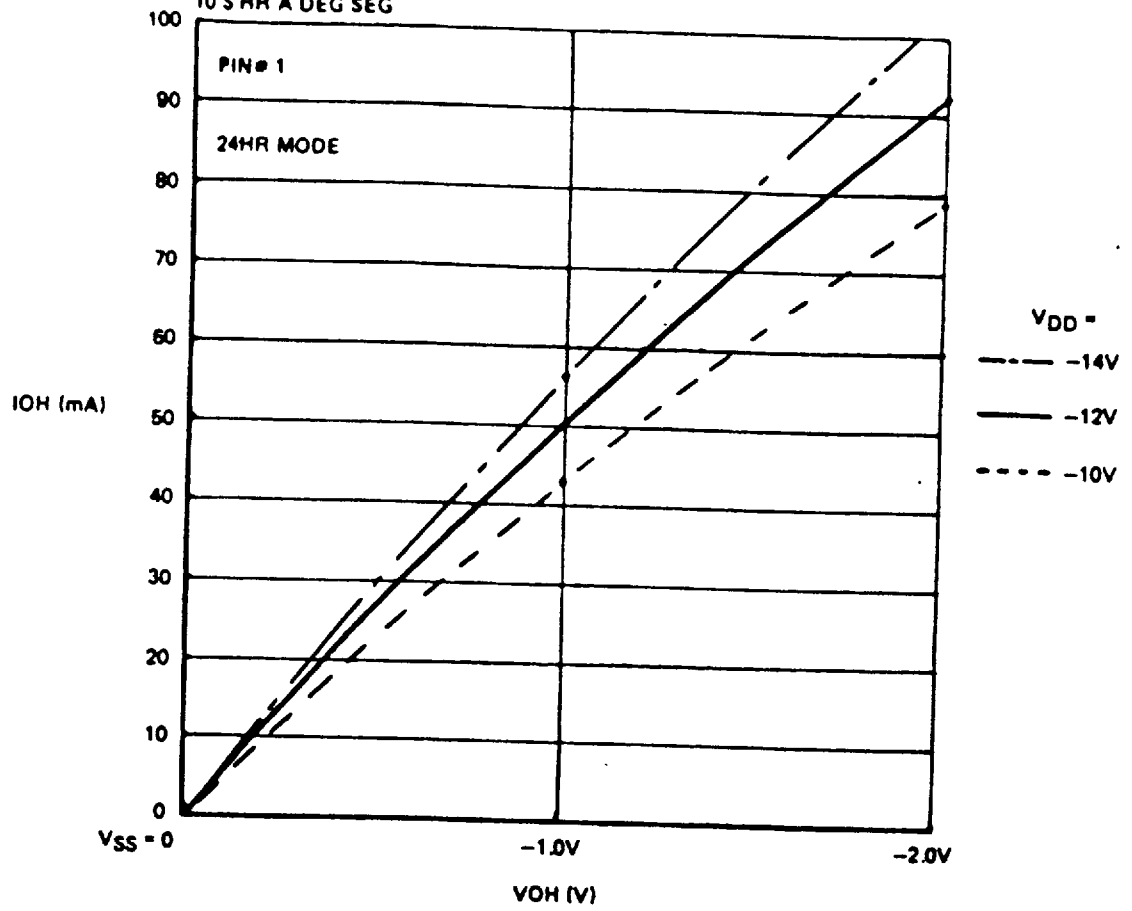

VOH = -1V	IOH (PIN# 1)		
	VDD = -10	-12	-14 V
$\bar{X} + 3\sigma$	46.7	54.3	60.8 mA
$\bar{X}$	43.4	50.2	56.3 mA
$\bar{X} - 3\sigma$	40.1	46.2	51.7 mA

# APPLICATION CIRCUIT FOR TMS 3450NL

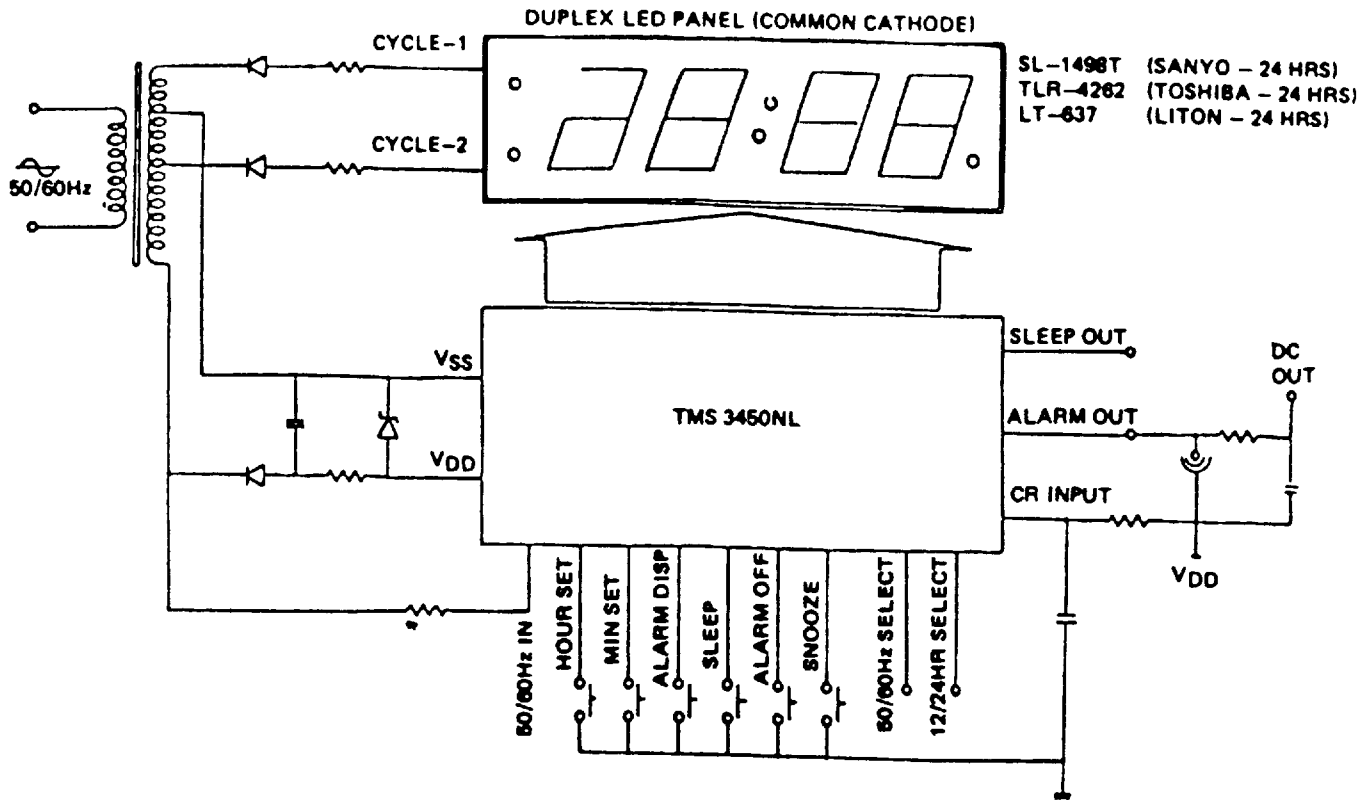

\* NOTE: FOR ELIMINATION OF POSSIBLE RFI IN LW-BAND, A OPTIMUM CIRCUIT WILL BE SUBMITTED LATER

## DUPLEX LED DISPLAY PANEL

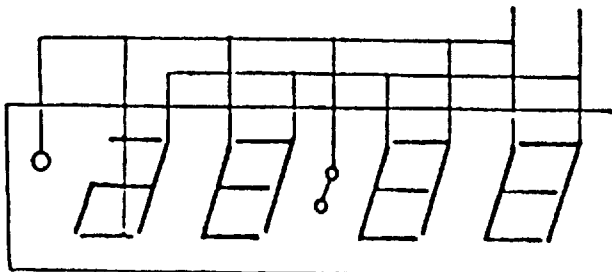
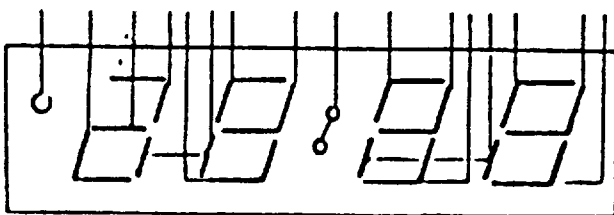

## PIN ASSIGNMENTS

AM & 10'S HR a & d	1	28	12/24HR SELECT
PM & 10'S HR b	2	27	CR INPUT
10'S HR c & HR e	3	26	50/60 Hz SELECT
HR b & g	4	25	50/60 Hz INPUT
HR c & d	5	24	SNOOZE INPUT
HR a & f	6	23	SLEEP INPUT
10'S MIN a & f	7	22	HOUR SET
10'S MIN b & g	8	21	MIN SET
10'S MIN c & d	9	20	Vdd
10'S MIN e & MIN e	10	19	ALARM-DISP
MIN b & g	11	18	ALARM-OFF
MIN c & d	12	17	SLEEP-OUT
MIN a & f	13	16	ALARM-OUT
COLON OUT	14	15	VSS

\* AM and PM of output signal will appear in 12HR-MODE.

28PIN 400MIL PACKAGE

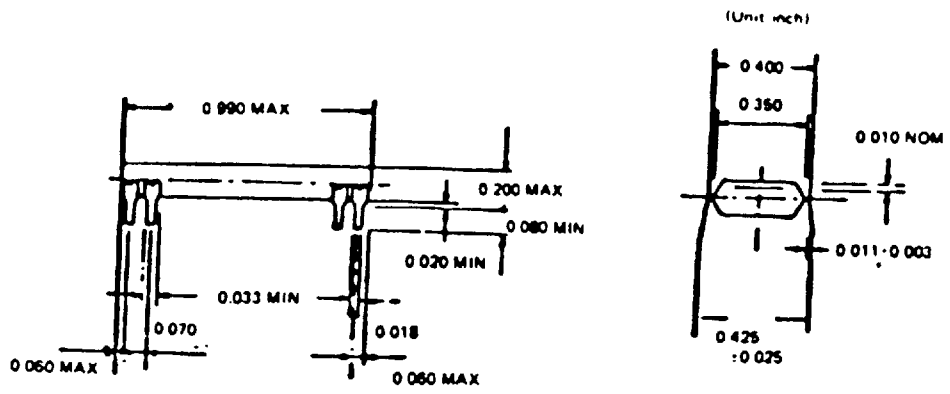

28PIN 400MIL PACKAGE

