

TOP VIEW

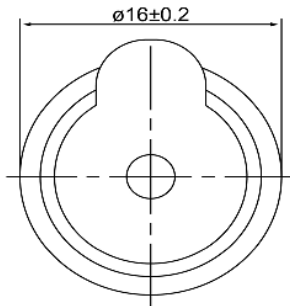

SIDE VIEW

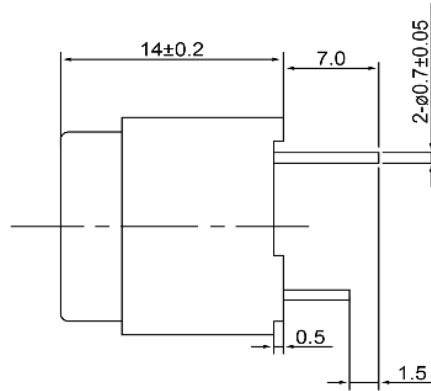

BOTTOM VIEW

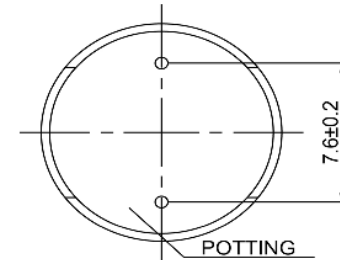

Specifications			Notes	Revision History						
Description	Value	Unit		Version	Description		Date	Approved		
Technology	Electro-Mechanical		1) All dimensions are in mm unless otherwise noted 2) All parts meet RoHS	1	Released from Engineering		10/21/2013	J.S		
Resonant Frequency	2,048	(Hz)								
Rated Voltage	6	(V)								
SPL @ 10cm	85	(dBA)								
Coil Resistance	50	(ohm)								
Mount Type	Thru Hole									
Voltage Range	4 ~ 8	(V)								
Max Rated Current	40	(mA)								
Housing Material	NORYL									
Operating Temperature	-30 ~ +70	°C								
Storage Temperature	-40 ~ +85	°C								
Weight	5	(g)								
 DB UNLIMITED			Electro-Mechanical Transducer			TE162006-3				

Additional considerations can be found at www.dbunlimitedco.com/technical-articles.