

MP-2835 Mid Power LED Color Series Package



Table of Contents

Technology Overview	2
Product Selection Table	3
Operating Characteristics	4
Chromaticity Coordinate Group	9
Ordering Nomenclature	15
Solder Profiles	18
Package Dimension	19
Taping Reel	20
Precaution for use	21

Features:

- Thermally Enhanced Package Design
- High luminous flux output
- High current capability
- Compact Package Size
- Pb-free Reflow Soldering Application
- RoHS compliant

Applications

- Horticulture
- Architectural
- Decorative
- Billboard Light
- Industrial

Technology Overview

Luminus mid power LEDs are lighting class solutions designed for high performance general lighting applications. These state-of-the-art LEDs allow illumination engineers and designers to develop lighting solutions with maximum efficacy, brightness and overall quality.

Reliability

Luminus mid power LEDs are one of the most reliable light sources in the world today. Having passed a rigorous suite of environmental and mechanical stress tests, including mechanical shock, vibration, temperature cycling and humidity, it is fully qualified for use in a wide range of high performance and high efficacy lighting applications.

REACH and RoHS Compliance

The Luminus 2835 mid power LED is compliant to the Restriction of Hazardous Substances Directive or RoHS. The restricted materials including lead, mercury cadmium hexavalent chromium, polybrominated biphenyls (PBB) and polybrominated diphenyl ether (PBDE) are not used.

Understanding Luminus™ Mid Power LED Test Specifications

Every Luminus LED is fully tested to ensure it meets the high quality standards customers have come to expect from Luminus products.

Testing Temperature

Luminus Mid Power products are measured at a junction temperature of 25C and placed into intensity, chromaticity and voltage bins as described here in

Product Selection Table

Test condition = 60 mA, 25 °C

Color	Part Number	Radiant Flux (mW)	
		Typ.	Min.
Meat Red	MP-2835-1100-MR	30	34
Deep Red	MP-2835-1100-DR	62	50
Far Red	MP-2835-1100-FR	45	34
Green	MP-2835-1100-PG	100	90
Blue	MP-2835-1200-B	115	90

*Tolerance of measurements of the luminous flux is $\pm 7\%$

*Tolerance of measurements of the CRI is ± 2

*IFP condition with Pulse: Width $\leq 100\mu\text{s}$ Duty cycle $\leq 1/10$

2835 Mid Power Operating Characteristics- Meat Red
Optical and Electrical Characteristics(Ta=25°C)

Parameter	Symbol	Minimum	Typical	Maximum	Unit	Condition
Forward Voltage	V _F	2.6	2.8	3.2	V	I _f
Reverse Current	I _R			10	uA	V _R =5V
View Angle	2θ ^{1/2}		120		°	I _f =60mA
Thermal Resistance	Rth _{J-SP}		21		°C/W	I _f =60mA
Electrostatic Discharge	ESD	1000			V	HBM
Radiant Flux	Φ _e	155	165	175	mW	I _f =60mA
Domant Wavelength	λ	635	640	645	nm	I _f =60mA

Absolute Maximum Ratings (Ta=25°C)

Parameter	Symbol	Rating	Unit
DC Forward Current	I _{FD}	200	mA
Peak Pulse Current (tp ≤10ms,Duty cycle = 1/10)	I _{FP}	280	mA
Reverse Voltage	V _R	5	V
Power Dissipation	P _D	600	W
LED Junction Temperature	T _J	115	°C
Operation Temperature	T _{OPR}	-40~+85	°C
Storage Temperature	T _{STG}	-40~+100	°C
Soldering Temperature	T _{SOL}	260° for 10 sec	°C

Note 1: To prevent damage refer to operating conditions and derating curves for appropriate maximum operating conditions

Note 2: Maximum operating case temperature combined with maximum drive current defines the total maximum operating condition for the device. To prevent damage, please follow derating curves for all operating conditions.

Note 3: Mid power LEDs are designed for operation up to an absolute maximum forward drive current as specified above. Product lifetime data is specified at typical forward drive currents. Sustained operation at absolute maximum currents will result in a reduction of device lifetime compared to typical forward drive currents. Actual device lifetimes will also depend on case temperature. Refer to the current vs. case temperature derating curves for further information.

Note 4: Caution must be taken not to stare at the light emitted from these LEDs. Under special circumstances, the high intensity could damage the eye.

*IFP condition with Pulse: Width ≤100μs Duty cycle ≤1/10

2835 Mid Power Operating Characteristics- Deep Red

Optical and Electrical Characteristics(Ta=25°C)

Parameter	Symbol	Minimum	Typical	Maximum	Unit	Condition
Forward Voltage	V _F	1.8	2.0	2.4	V	I _f
Reverse Current	I _R			10	uA	V _R =5V
View Angle	2θ ^{1/2}		120		°	I _f =60mA
Thermal Resistance	Rth _{J-SP}		20		°C/W	I _f =60mA
Electrostatic Discharge	ESD	1000			V	HBM
Radiant Flux	Φ _e	50	63		mW	I _f =60mA
Domant Wavelength	λ	650	660	665	nm	I _f =60mA

Absolute Maximum Ratings (Ta=25°C)

Parameter	Symbol	Rating	Unit
DC Forward Current	I _{FD}	200	mA
Peak Pulse Current (tp ≤10ms,Duty cycle = 1/10)	I _{FP}	280	mA
Reverse Voltage	V _R	5	V
Power Dissipation	P _D	440	W
LED Junction Temperature	T _J	115	°C
Operation Temperature	T _{OPR}	-40~+85	°C
Storage Temperature	T _{STG}	-40~+100	°C
Soldering Temperature	T _{SOL}	260° for 10 sec	°C

Note 1: To prevent damage refer to operating conditions and derating curves for appropriate maximum operating conditions

Note 2: Maximum operating case temperature combined with maximum drive current defines the total maximum operating condition for the device. To prevent damage, please follow derating curves for all operating conditions.

Note 3: Mid power LEDs are designed for operation up to an absolute maximum forward drive current as specified above. Product lifetime data is specified at typical forward drive currents. Sustained operation at absolute maximum currents will result in a reduction of device lifetime compared to typical forward drive currents. Actual device lifetimes will also depend on case temperature. Refer to the current vs. case temperature derating curves for further information.

Note 4: Caution must be taken not to stare at the light emitted from these LEDs. Under special circumstances, the high intensity could damage the eye.

*IFP condition with Pulse: Width ≤100μs Duty cycle ≤1/10

2835 Mid Power Operating Characteristics- Far Red

Optical and Electrical Characteristics(Ta=25°C)

Parameter	Symbol	Minimum	Typical	Maximum	Unit	Condition
Forward Voltage	V _F	1.6	1.9	2.2	V	I _f
Reverse Current	I _R			10	uA	V _R =5V
View Angle	2θ ^{1/2}		120		°	I _f =60mA
Thermal Resistance	R _{th} _{j-sp}		20		°C/W	I _f =60mA
Electrostatic Discharge	ESD	1000			V	
Radiant Flux	Φ _e	34	45	50	mW	I _f =60mA
Peak Wavelength	λ	725	730	740	nm	I _f =60mA

Absolute Maximum Ratings (Ta=25°C)

Parameter	Symbol	Rating	Unit
DC Forward Current	I _{FD}	500	mA
Peak Pulse Current (tp ≤10ms,Duty cycle = 1/10)	I _{FP}	550	mA
Reverse Voltage	V _R	5	V
Power Dissipation	P _D	1100	W
LED Junction Temperature	T _J	115	°C
Operation Temperature	T _{OPR}	-40~+85	°C
Storage Temperature	T _{STG}	-40~+100	°C
Soldering Temperature	T _{SOL}	260° for 10 sec	°C

Note 1: To prevent damage refer to operating conditions and derating curves for appropriate maximum operating conditions

Note 2: Maximum operating case temperature combined with maximum drive current defines the total maximum operating condition for the device. To prevent damage, please follow derating curves for all operating conditions.

Note 3: Mid power LEDs are designed for operation up to an absolute maximum forward drive current as specified above. Product lifetime data is specified at typical forward drive currents. Sustained operation at absolute maximum currents will result in a reduction of device lifetime compared to typical forward drive currents. Actual device lifetimes will also depend on case temperature. Refer to the current vs. case temperature derating curves for further information.

Note 4: Caution must be taken not to stare at the light emitted from these LEDs. Under special circumstances, the high intensity could damage the eye.

*IFP condition with Pulse: Width ≤100μs Duty cycle ≤1/10

2835 Mid Power Operating Characteristics- Blue

Optical and Electrical Characteristics(Ta=25°C)

Parameter	Symbol	Minimum	Typical	Maximum	Unit	Condition
Forward Voltage	V _F	2.6	2.8	3.2	V	I _f
Reverse Current	I _R			10	uA	V _R =5V
View Angle	2θ ^{1/2}		120		°	I _f =60mA
Thermal Resistance	R _{th} _{J-SP}		22		°C/W	I _f =60mA
Electrostatic Discharge	ESD	1000			V	
Radiant Flux	Φ _e	90	115	130	mW	I _f =60mA
Domant Wavelength	λ	450	460	465	nm	I _f =60mA

Absolute Maximum Ratings (Ta=25°C)

Parameter	Symbol	Rating	Unit
DC Forward Current	I _{FD}	250	mA
Peak Pulse Current (tp ≤10ms,Duty cycle = 1/10)	I _{FP}	280	mA
Reverse Voltage	V _R	5	V
Power Dissipation	P _D	440	W
LED Junction Temperature	T _J	120	°C
Operation Temperature	T _{OPR}	-40~+85	°C
Storage Temperature	T _{STG}	-40~+100	°C
Soldering Temperature	T _{SOL}	260° for 10 sec	°C

Note 1: To prevent damage refer to operating conditions and derating curves for appropriate maximum operating conditions

Note 2: Maximum operating case temperature combined with maximum drive current defines the total maximum operating condition for the device. To prevent damage, please follow derating curves for all operating conditions.

Note 3: Mid power LEDs are designed for operation up to an absolute maximum forward drive current as specified above. Product lifetime data is specified at typical forward drive currents. Sustained operation at absolute maximum currents will result in a reduction of device lifetime compared to typical forward drive currents. Actual device lifetimes will also depend on case temperature. Refer to the current vs. case temperature derating curves for further information.

Note 4: Caution must be taken not to stare at the light emitted from these LEDs. Under special circumstances, the high intensity could damage the eye.

*IFP condition with Pulse: Width ≤100μs Duty cycle ≤1/10

2835 Mid Power Operating Characteristics- Green
Optical and Electrical Characteristics(Ta=25°C)

Parameter	Symbol	Minimum	Typical	Maximum	Unit	Condition
Forward Voltage	V _F	2.6	2.82	3.2	V	I _f
Reverse Current	I _R			10	uA	V _R =5V
View Angle	2θ ^{1/2}		120		°	I _f =60mA
Thermal Resistance	R _{th j-sp}		16		°C/W	I _f =60mA
Electrostatic Discharge	ESD	1000			V	HBM
Radiant Flux	Φ _e	90	100	110	mW	I _f =60mA
Dominant Wavelength	λ	510		525	nm	I _f =60mA

Parameter	Symbol	Rating	Unit
DC Forward Current	I _{FD}	240	mA
Peak Pulse Current (tp ≤10ms,Duty cycle = 1/10)	I _{FP}	260	mA
Reverse Voltage	V _R	5	V
Power Dissipation	P _D	768	mW
LED Junction Temperature	T _J	120	°C
Operation Temperature	T _{OPR}	-40~+85	°C
Storage Temperature	T _{STG}	-40~+100	°C
Soldering Temperature	T _{SOL}	260° for 10 sec	°C

Note 1: To prevent damage refer to operating conditions and derating curves for appropriate maximum operating conditions

Note 2: Maximum operating case temperature combined with maximum drive current defines the total maximum operating condition for the device. To prevent damage, please follow derating curves for all operating conditions.

Note 3: Mid power LEDs are designed for operation up to an absolute maximum forward drive current as specified above. Product lifetime data is specified at typical forward drive currents. Sustained operation at absolute maximum currents will result in a reduction of device lifetime compared to typical forward drive currents. Actual device lifetimes will also depend on case temperature. Refer to the current vs. case temperature derating curves for further information.

Note 4: Caution must be taken not to stare at the light emitted from these LEDs. Under special circumstances, the high intensity could damage the eye.

*IFP condition with Pulse: Width ≤100μs Duty cycle ≤1/10

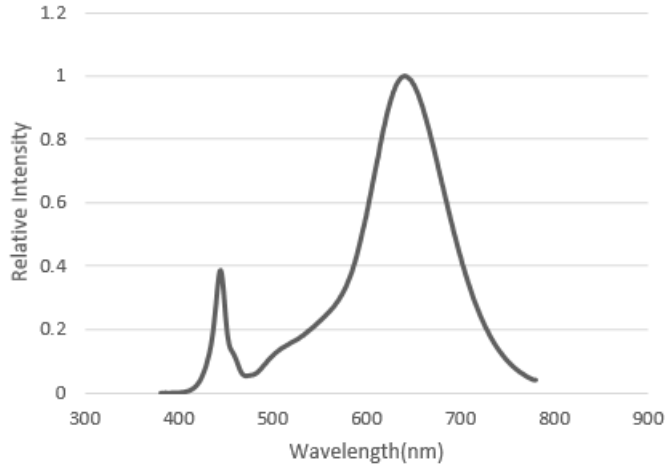
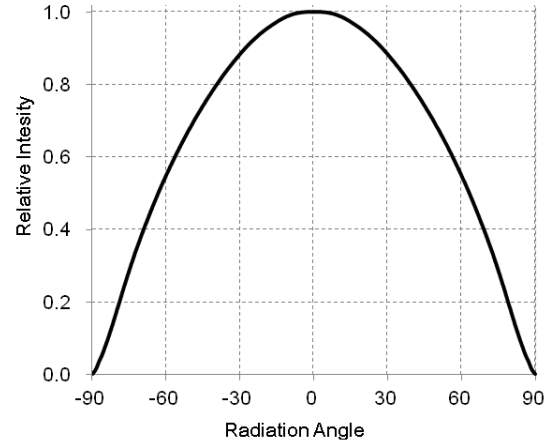
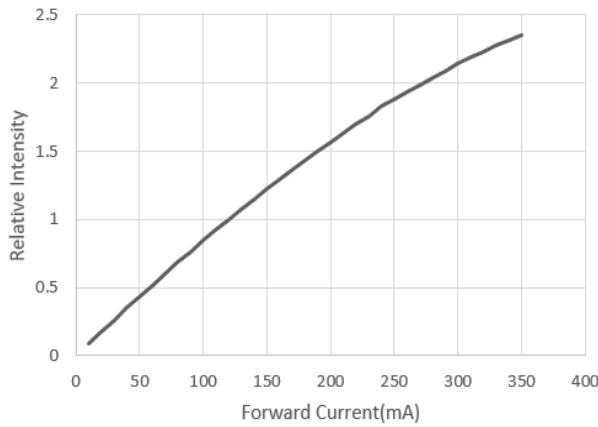
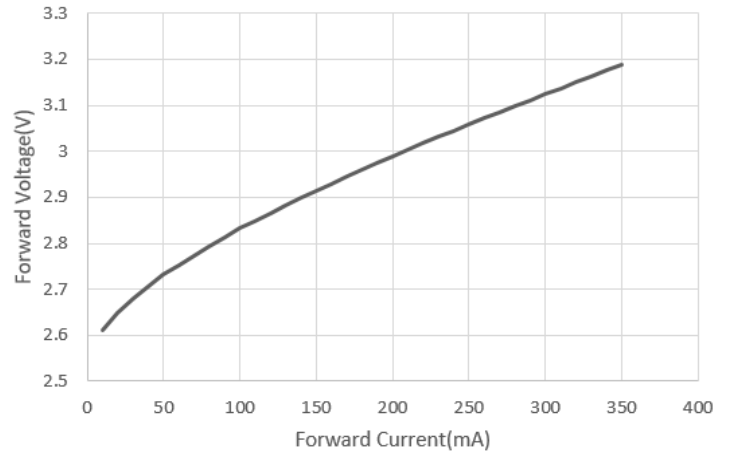
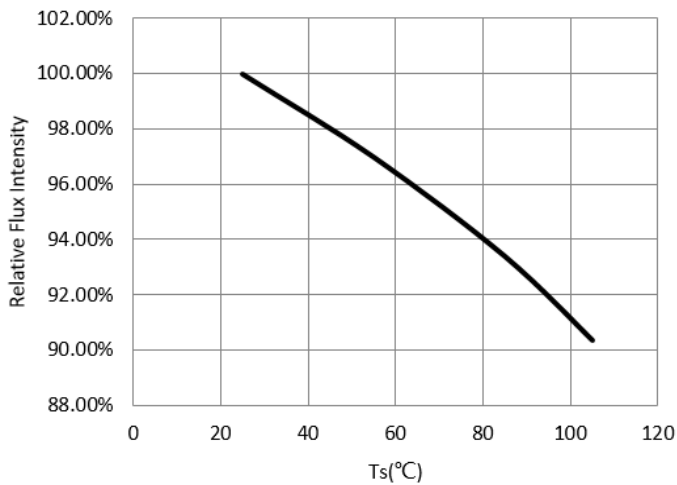
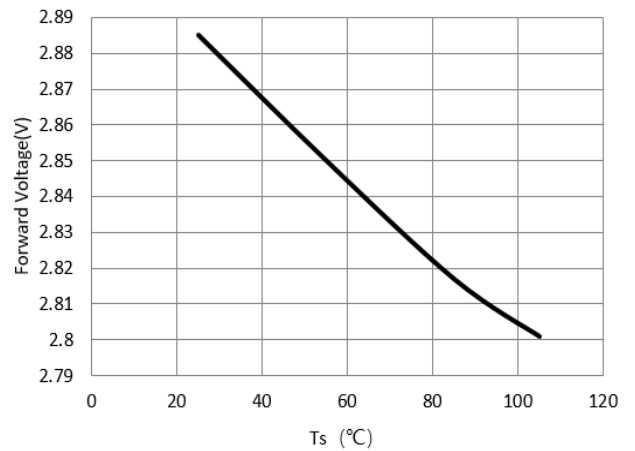
Typical Optical/Electrical Characteristics Graphs- Meat Red
Color Spectrum (T_j=25°C)

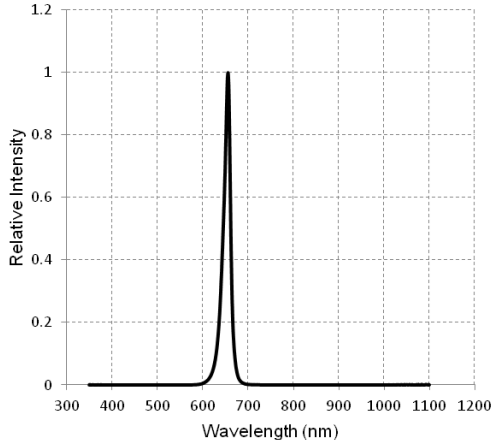
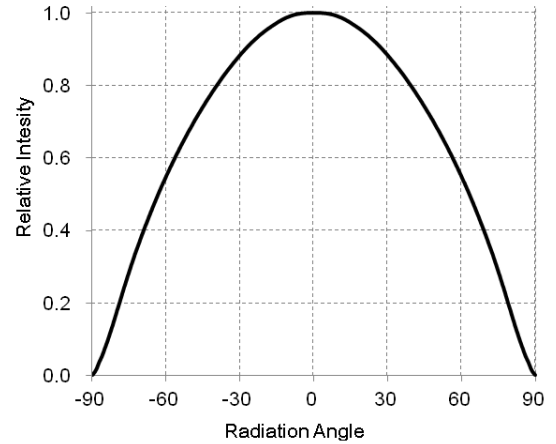
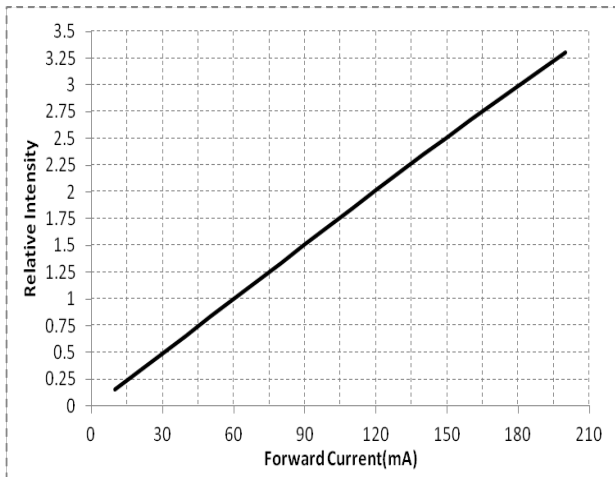
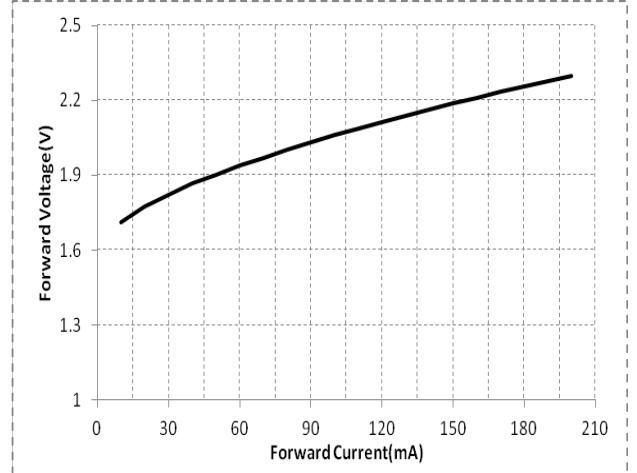
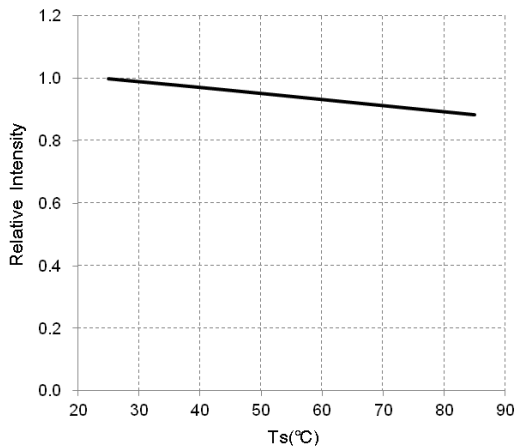
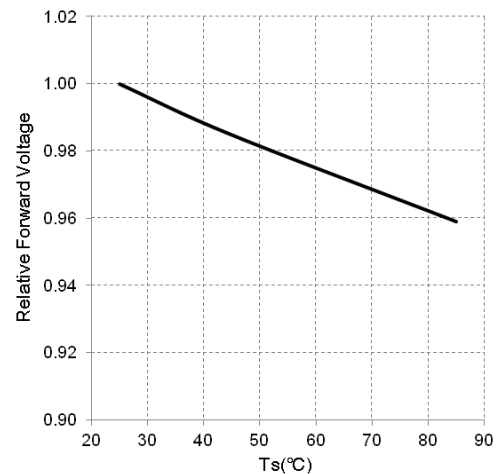
Viewing Angle Distribution (T_j=25°C)

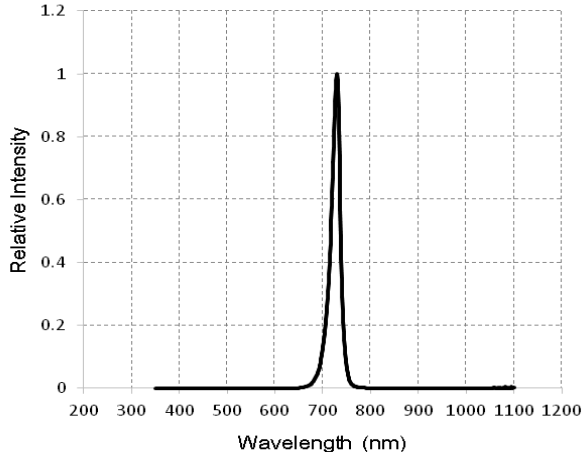
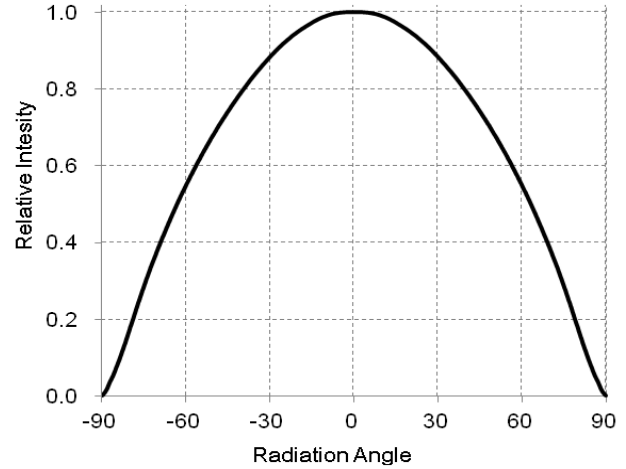
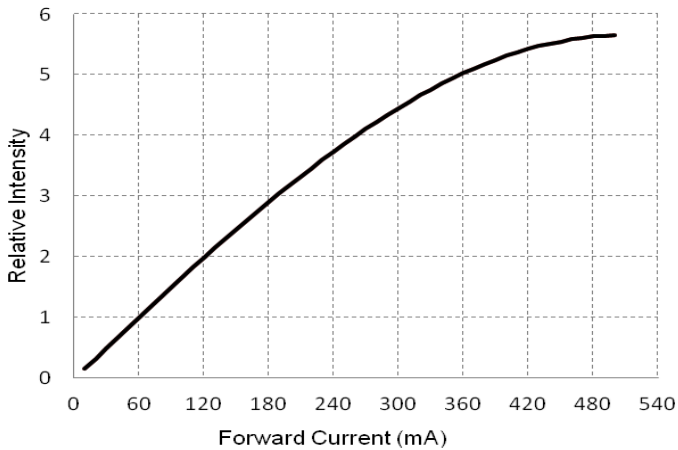
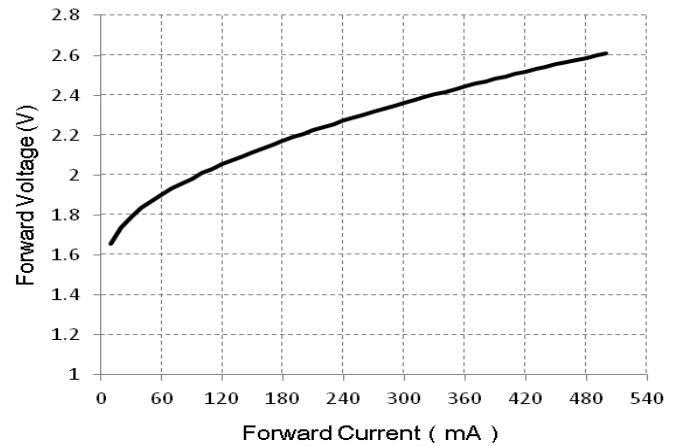
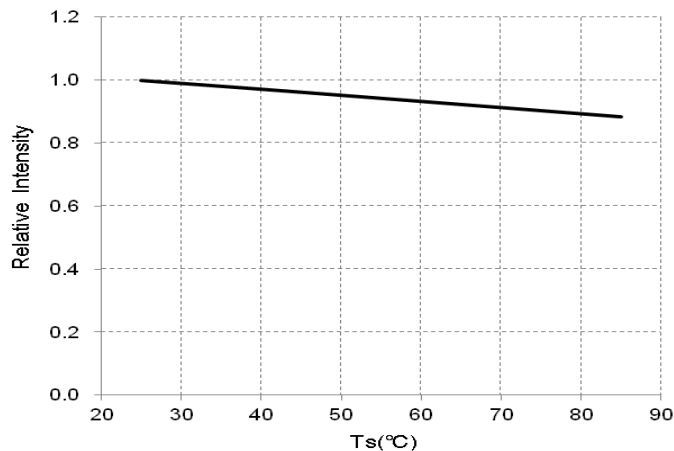
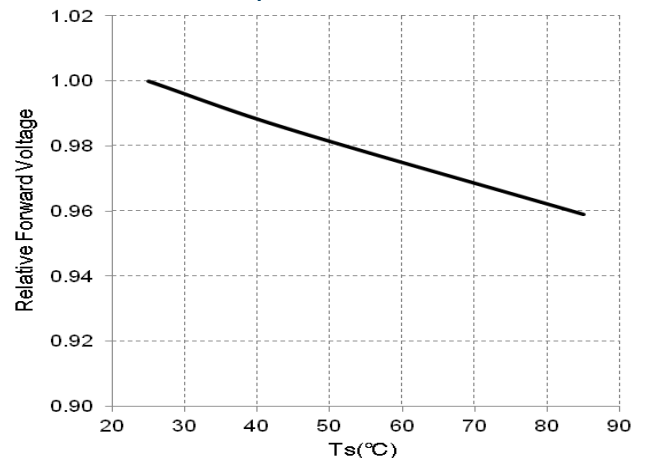
Forward Current vs. Relative Intensity (T_j=25°C)

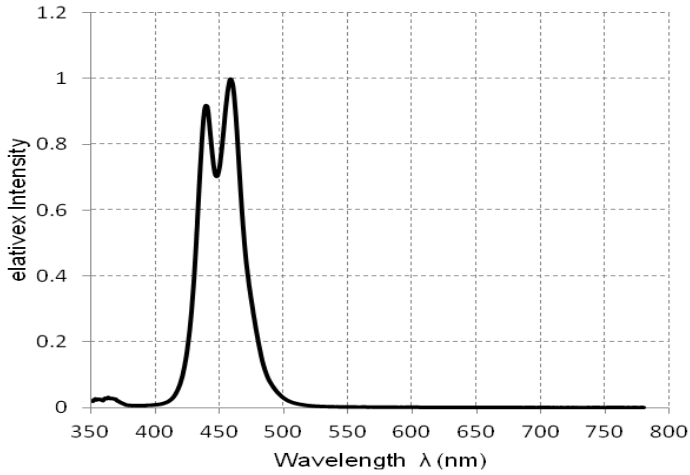
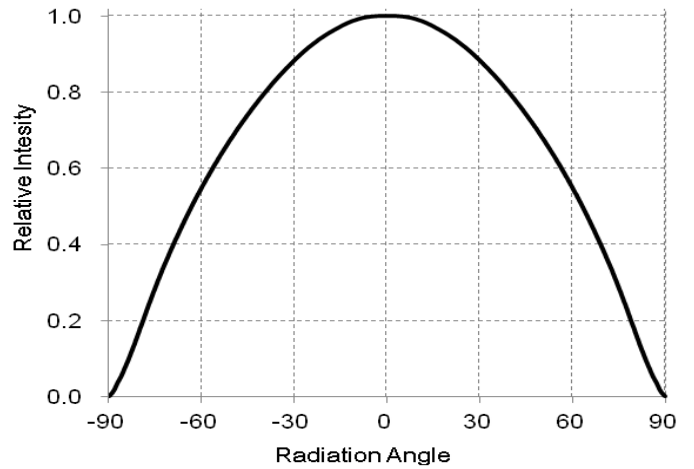
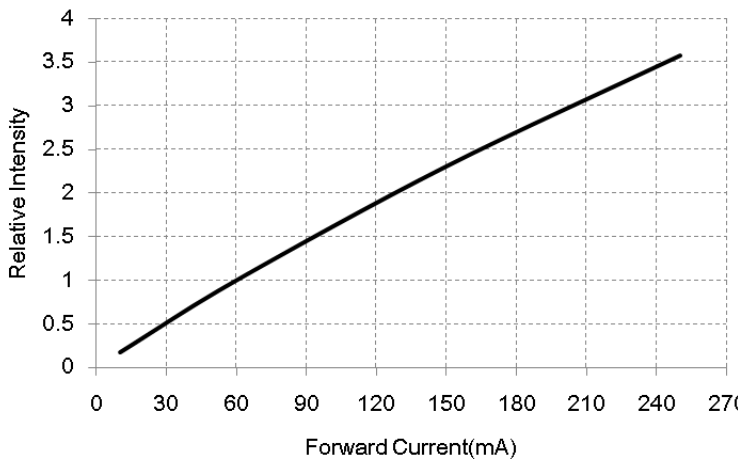
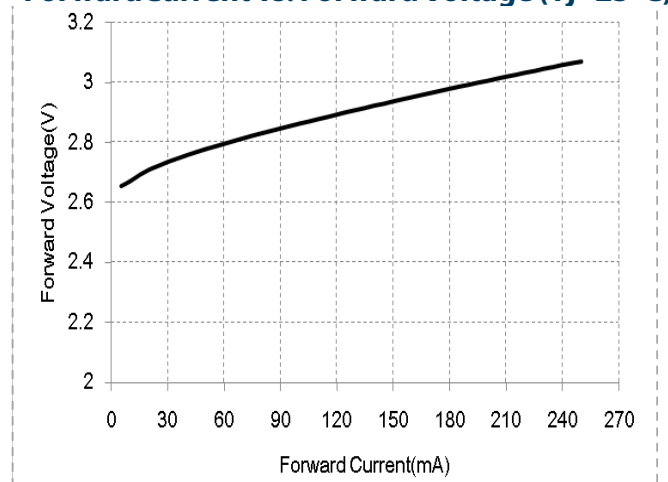
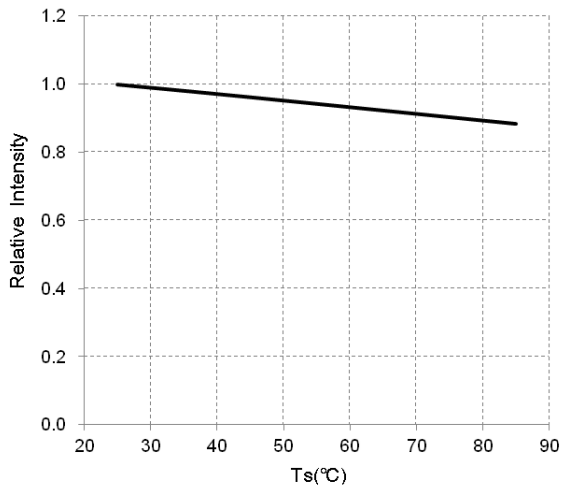
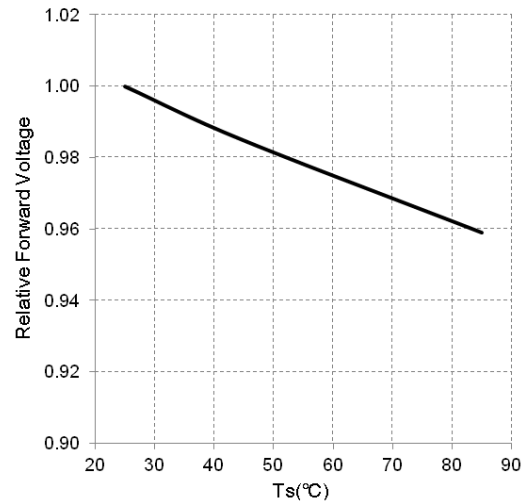
Forward Current vs. Forward Voltage (T_j=25°C)

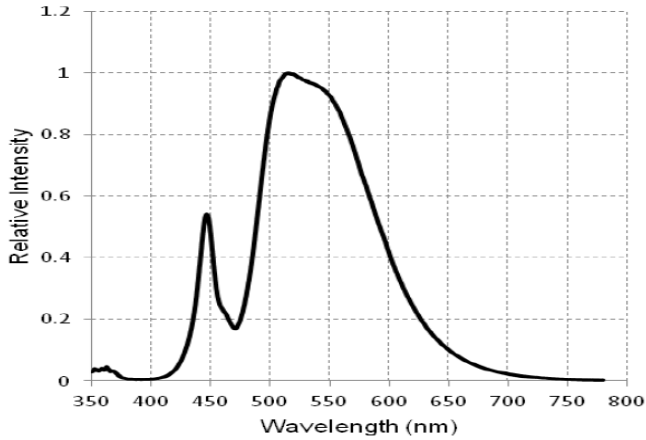
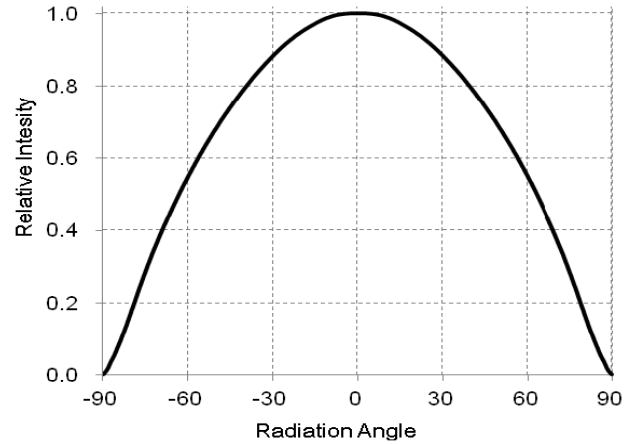
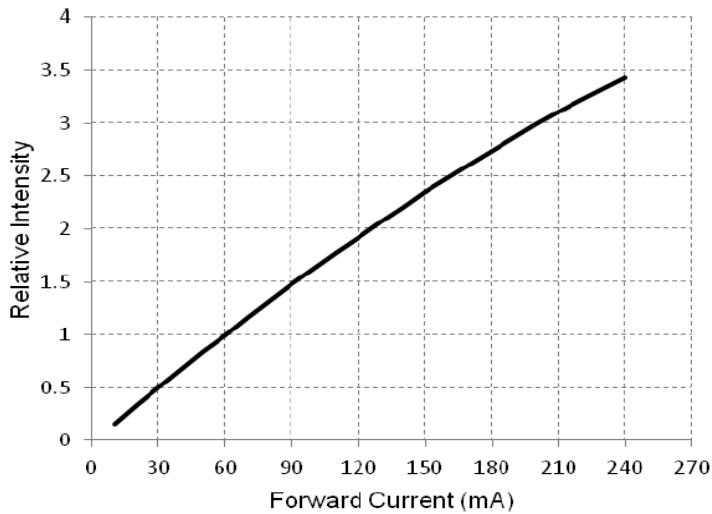
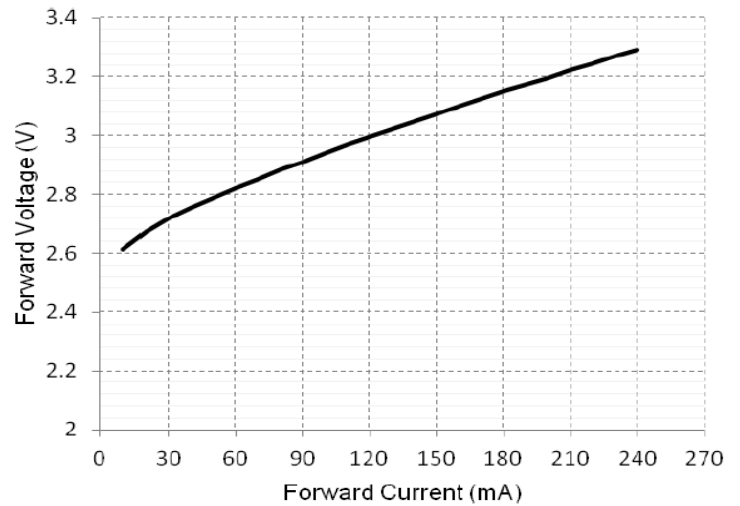
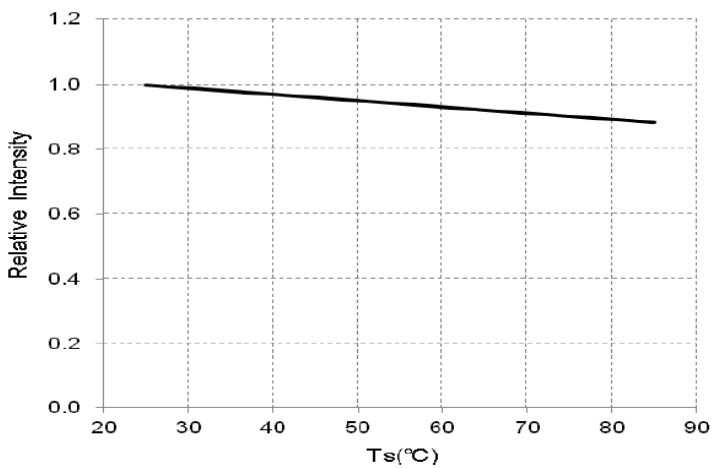
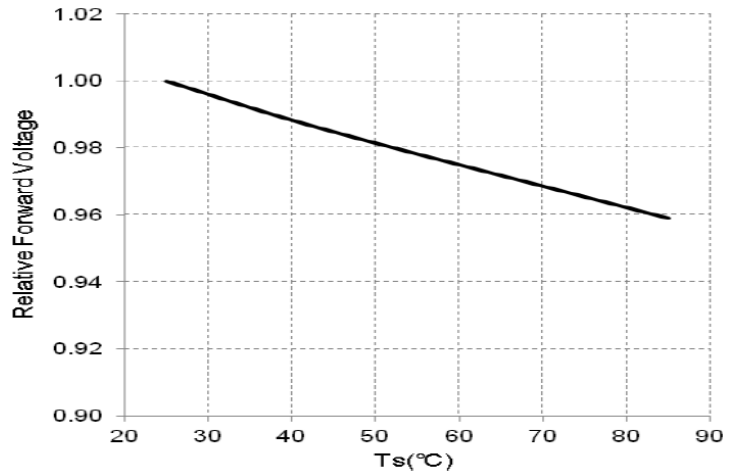
Temperature vs Relative Luminous flux (I_f=120mA)

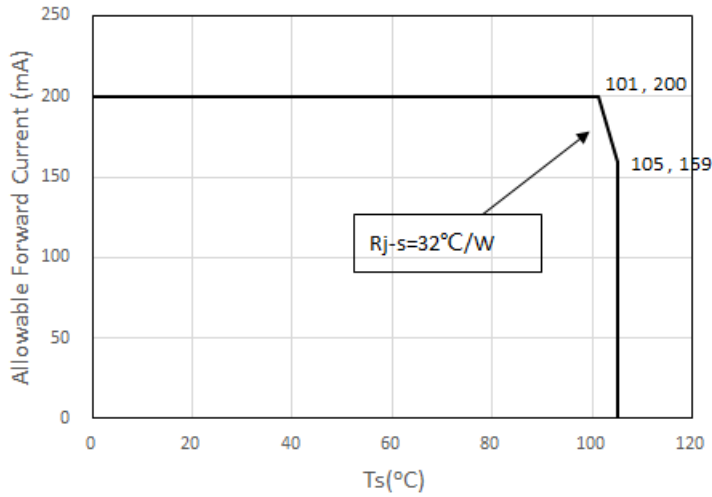
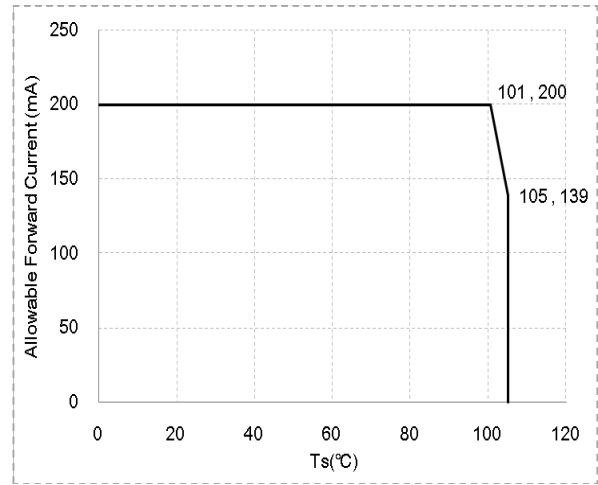
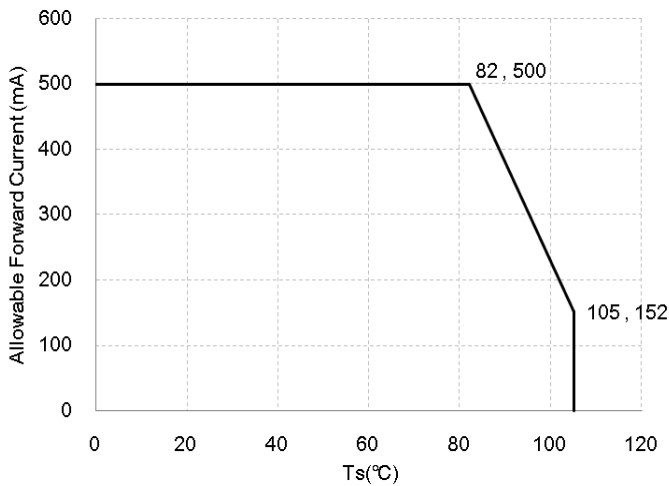
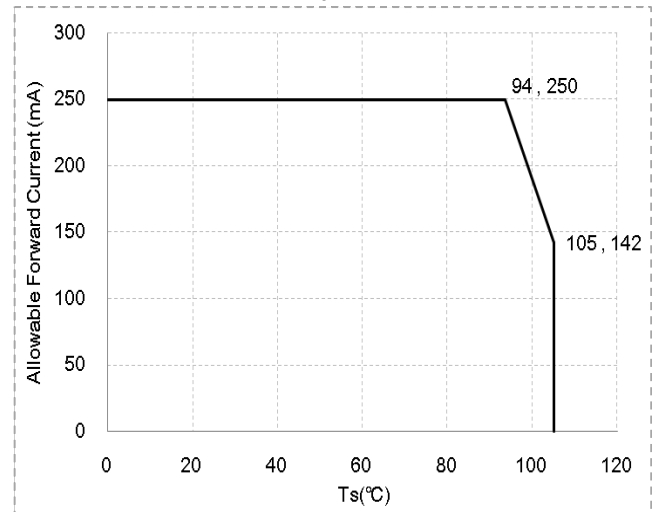
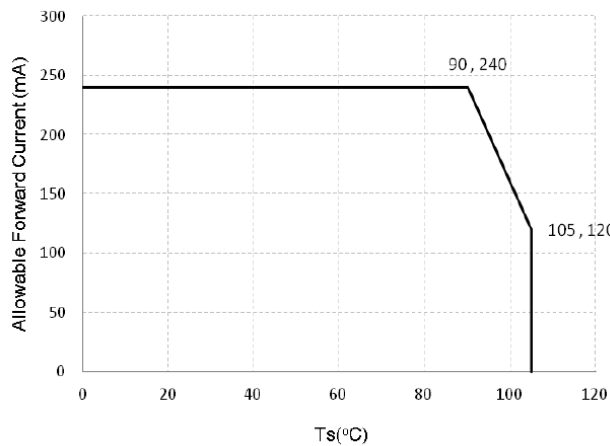
Temperature vs. Forward Voltage (I_f=120mA)

Typical Optical/Electrical Characteristics Graphs- Deep Red
Color Spectrum (T_j=25°C)

Viewing Angle Distribution (T_j=25°C)

Forward Current vs. Relative Intensity (T_j=25°C)

Forward Current vs. Forward Voltage (T_j=25°C)

**Case Temperature vs Relative Luminous flux
(I_f=60mA)**

Case temperature vs. Relative Forward Voltage (I_f=60mA)

Typical Optical/Electrical Characteristics Graphs- Far Red
Color Spectrum (T_j=25°C)

Viewing Angle Distribution (T_j=25°C)

Forward Current vs. Relative Intensity (T_j=25°C)

Forward Current vs. Forward Voltage (T_j=25°C)

**Case Temperature vs Relative Luminous flux
(I_f=60mA)**

**Case temperature vs. Relative Forward Voltage (
I_f=60mA)**

Typical Optical/Electrical Characteristics Graphs- Blue
Color Spectrum (T_j=25°C)

Viewing Angle Distribution (T_j=25°C)

Forward Current vs. Relative Intensity (T_j=25°C)

Forward Current vs. Forward Voltage (T_j=25°C)

**Case Temperature vs Relative Luminous flux
(I_f=60mA)**

Case temperature vs. Relative Forward Voltage (I_f=60mA)

Typical Optical/Electrical Characteristics Graphs- Green
Color Spectrum (T_j=25°C)

Viewing Angle Distribution (T_j=25°C)

Forward Current vs. Relative Intensity (T_j=25°C)

Forward Current vs. Forward Voltage (T_j=25°C)

**Case Temperature vs Relative Luminous flux
(I_f=60,mA)**

Case temperature vs. Relative Forward Voltage (I_f=60,mA)

Allowable Forward Current vs. Case Temperature ($T_j < 120^\circ\text{C}$)

Meat Red

Deep Red

Far Red

Blue

Green

Product Ordering and Shipping Part Number Nomenclature

All mid power products are packaged and labeled with part numbers as outlined in below. When shipped, each reel will contain only a single flux and voltage bin. The part number designation is as follows:

2835 Mid Power LEDs

Mid Power	Package Type	Package Configurator	Color	Radiant Flux	Forward Voltage	Peak Wavelength
MP	2835	1100/1200	MR (Meat Red) RD (Deep Red) FR (Far Red) B (Blue)	##	##	##

Example:

The part number MP-2835-2100-B-xxxxxxx refers to a 2835 mid power emitter with nominal color temperature of 3,000k and minimum CRI of 80. Please refer to page 5 for a description of available CCT and CRI combinations.

Luminus Intensity Rank

Bin Code	Minimum	Maximum	Unit
D8	30	32	lm
D9	32	34	lm
E1	34	36	lm
6D	34	42	lm
6E	42	50	lm
6F	50	58	lm
6G	58	66	lm
6H	66	74	lm
6L	90	98	lm
6M	98	110	lm
6N	110	122	lm
6P	122	134	lm

Forward Voltage Bin

Bin Code	Minimum	Maximum	Unit
A	2.7	2.8	V
B	2.8	2.9	V
C	2.9	3.0	V
B3	1.6	1.8	V
C3	1.8	2.0	V
D3	2.0	2.2	V
E3	2.2	2.4	V
G3	2.6	2.8	V
H3	2.8	3.2	V
J3	3.0	3.2	V

*Tolerance of measurements of the Forward Voltage is $\pm 0.1V$

Product Ordering and Shipping Part Number Nomenclature
Wavelength Bin

Bin Code	Minimum (nm)	Maximum (nm)
B2	450	455
B3	455	460
B4	460	465
GK	510	515
GE	515	520
GF	520	525
R5	635	640
R6	640	645
R7	645	650
R8	650	655
R9	655	660
RA	660	665
RP	725	730
RQ	730	735

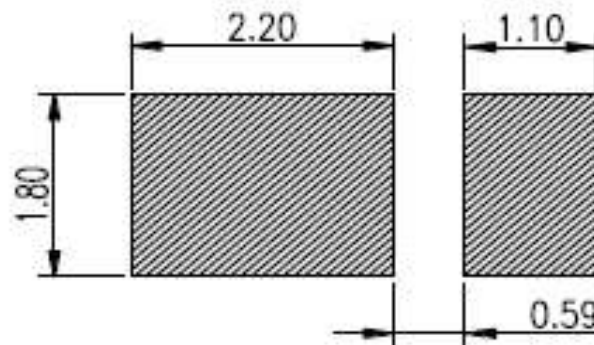
Recommended Solder Pad

*All dimensions are in millimeters

*Scale : 1:1

*This drawing without tolerances are for reference only

*Undefined tolerance: $\pm 0.10\text{mm}$

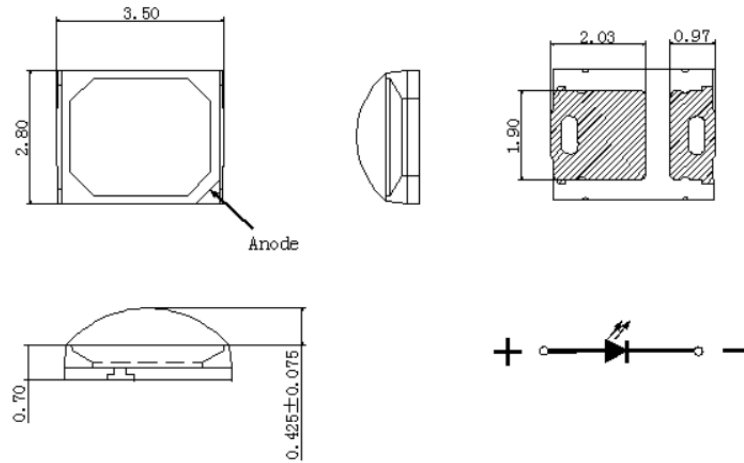
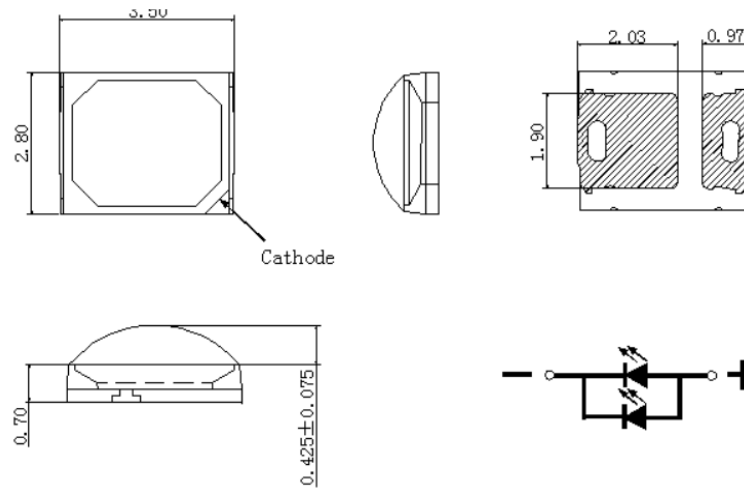
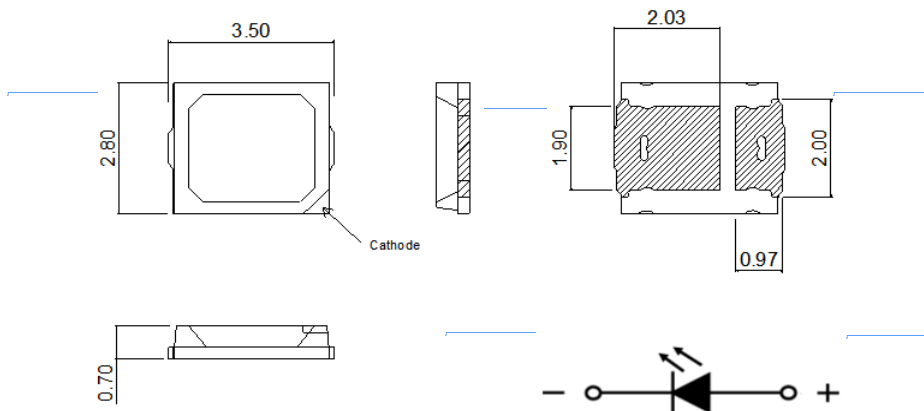
Mechanical Drawing
Red/ FarRed/ Pure Green

Blue

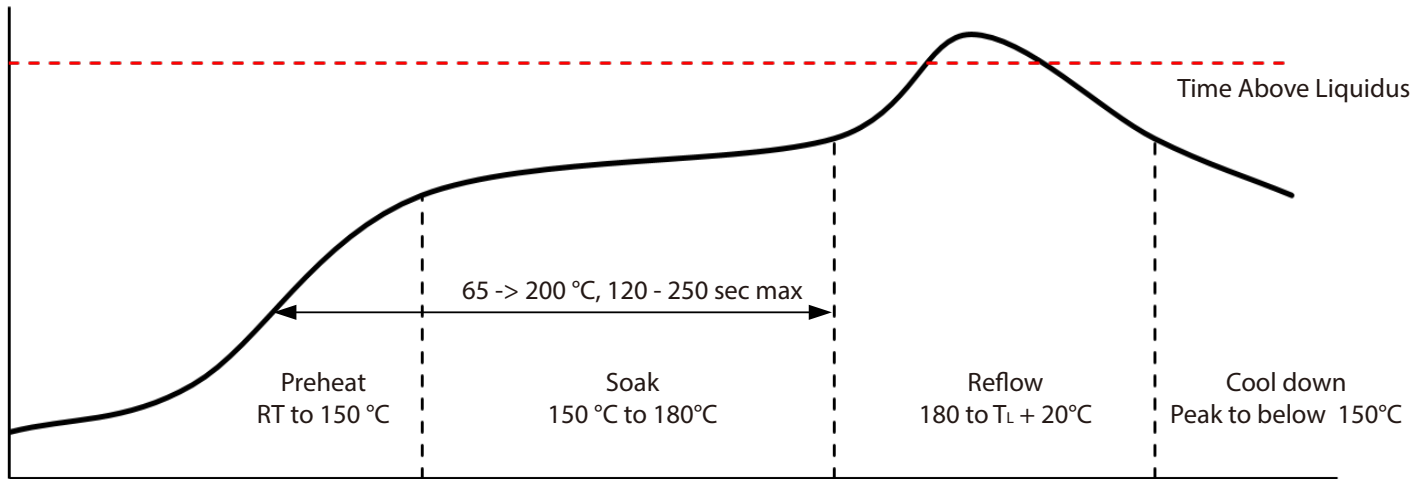
Meat Red

Solder Profile



SMT Rework Guideline	Manual Hotplate Reflow	Hot Air Gun Reflow
Heating Time	< 60 sec	
Hotplate Temperature	< 245°C	< 150°C

Note 1: Product complies to Moisture Sensitivity Level 3 (MSL 3).

Note 2: The numbers in the table are specific to SAC305. Luminus recommends using an SAC305 solder paste with a no-clean flux for RoHS compliant products.

Note 3: During the pick and place process, axial forces on the dome (or window) should not exceed 0.5 Newtons (N).

Note 4: Use of a multi-zone IR reflow oven with a nitrogen blanket is recommended.

Note 5: Time-temperature profile of the reflow process showing the four functional profile zones are defined in IPC-7801. Temperature is referenced to the center of the PCB.

Note 6: Luminus recommends to use the solder paste data sheet information as a starting point in time-temperature process development.

Note 7: These are general guidelines. Consult the solder paste manufacturer's datasheet for guidelines specific to the alloy and flux combination used in your application. For more information, please refer to:

<https://luminusdevices.zendesk.com/hc/en-us/articles/360060306692-How-do-I-Reflow-Solder-Luminus-SMD-Components->

Note 8: For any technical questions about soldering process, please contact Luminus at techsupport@luminus.com.

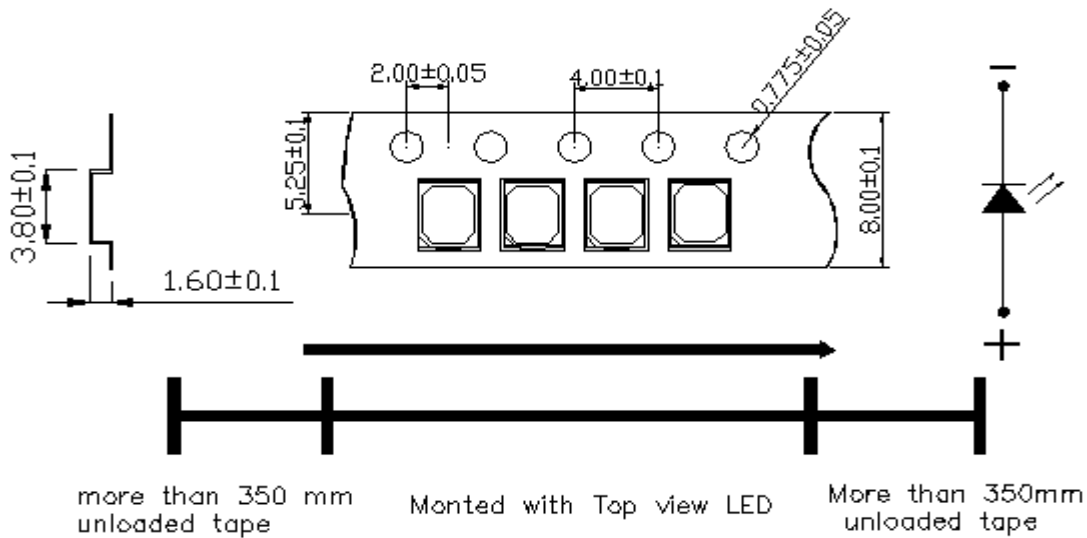
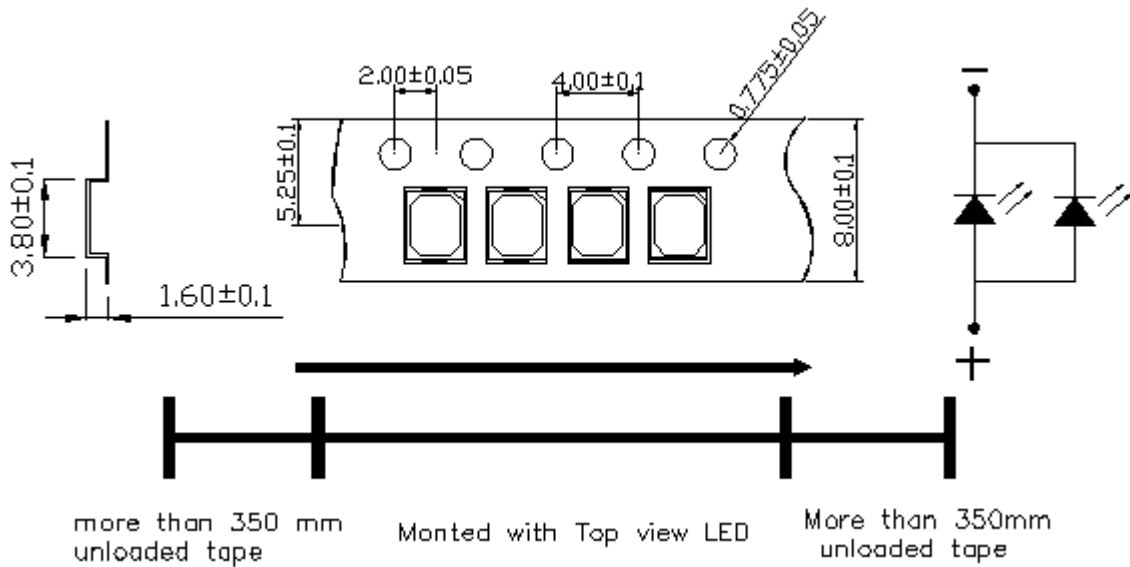
Package Taping Reel -(mm)
Deep Red/ Far Red/Meat Red

Blue

* Quantity : Max 2000pcs/Reel.

* Cumulative Tolerance : Cumulative Tolerance/10 pitches to be ± 0.2 mm.

* Package : P/N, Manufacturing data Code No. and Quantity to be indicated on a damp proof Package.

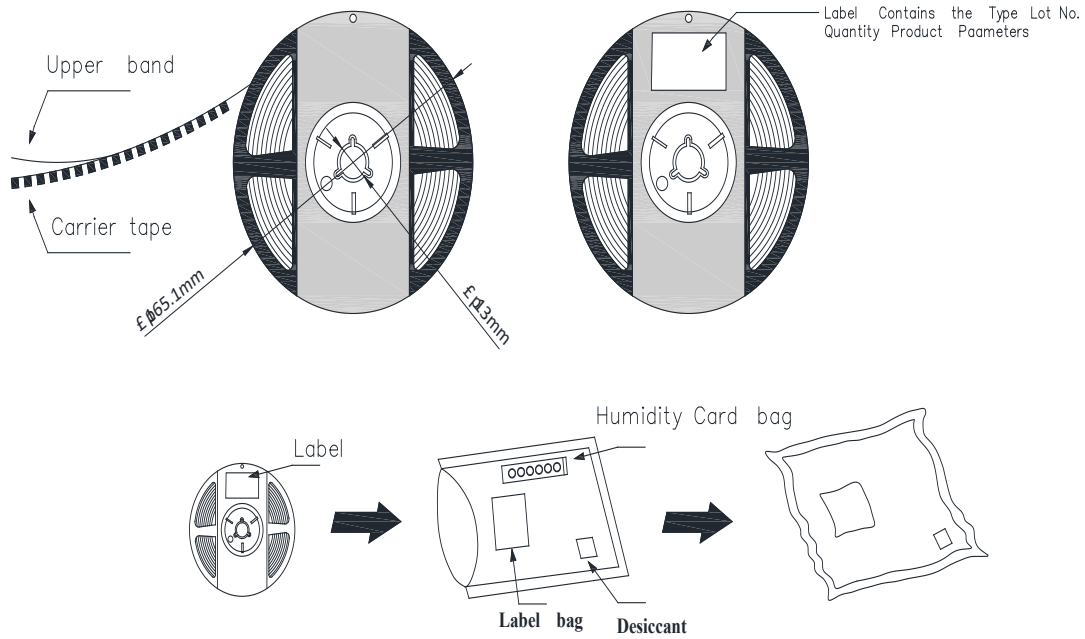
Packaging Reel



Package Box

Packaging Box

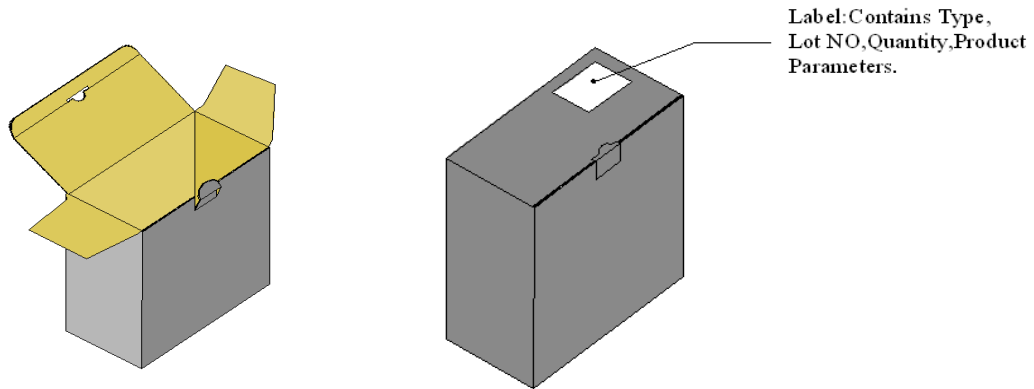

- Capacity 5 or 10 reels per box

Shipping Box

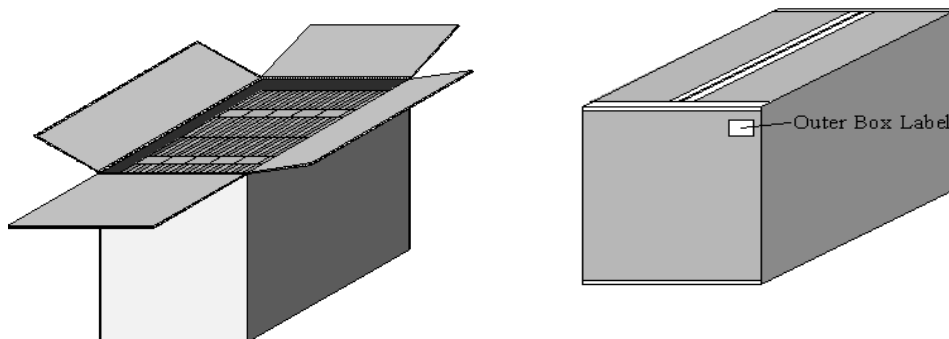

- Capacity 40 or 60 reels per box

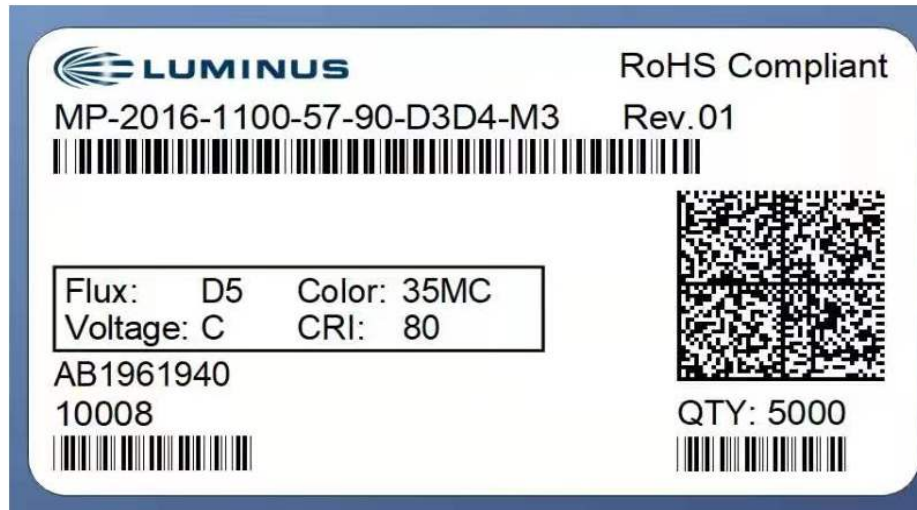
Label**Precaution for Use****STORAGE****1.1 Before opening the package**

The LEDs should be kept at $<40^{\circ}\text{C}$ & $<90\%\text{RH}$. The LEDs should be used within a year. When storing the LEDs, moisture proof package with absorbent material (silica gel) is recommended.

1.2 After opening the package

The LEDs should be kept at $\leq 30^{\circ}\text{C}$ & $\leq 60\%\text{RH}$. The LEDs should be soldered within 72 hours (3 days) after opening the moisture proof package.

If unused LEDs remain, they should be stored in moisture proof packages, such as sealed containers with moisture proof package within absorbent material (silica gel). It is also recommended to return the unused LEDs to the original moisture proof package and to seal the moisture proof package again.

If the moisture absorbent material (silica gel) vapors or expires the expiration date, baking treatment should be performed by using the following conditions : 60°C for 20 hours.

The LEDs electrode and leadframe comprise a silver plated copper alloy. The silver surface may be affected by environments. Please avoid conditions which may cause the LEDs being corroded or discolored. The corrosion or discoloration might lower solderability or affect optical characteristics.

Please avoid rapid transition in ambient temperature, especially in high humidity environments where condensation can occur.

STATIC ELECTRICITY

The products are sensitive to static electricity and highly taken care when handling them.

Static electricity or surge voltage will damage the LEDs. It is recommended to wear an anti-electrostatic wristband or an anti-electrostatic glove when handling the LEDs.

All devices, equipment and machinery must be properly grounded. It is recommended that measures be taken against surge voltage to the equipment that mounts the LEDs.