

**CUI INC**

a bel group

date 06/13/2022

page 1 of 8

**SERIES:** PSK-3D | **DESCRIPTION:** INTERNAL AC-DC POWER SUPPLY**FEATURES**

- wide input range (85 ~ 305 Vac)
- wide operating temperature range (-40 to +85 C)
- Class B emissions
- certified to 62368, 61558, and 60335 safety standards
- over voltage, over current, short circuit protections
- compact 1 x 1 inch encapsulated package



MODEL	output voltage	output current	output power	ripple and noise <sup>1</sup>	efficiency <sup>2</sup>
	(Vdc)	max (A)	max (W)	max (mVp-p)	typ (%)
PSK-3D-3	3.3	0.9	3	100	72
PSK-3D-5	5	0.6	3	100	76
PSK-3D-9	9	0.333	3	100	78
PSK-3D-12	12	0.25	3	100	78
PSK-3D-15	15	0.2	3	100	79
PSK-3D-24	24	0.125	3	100	79

Notes: 1. Ripple & noise are measured at 20 MHz BW with 10  $\mu$ F aluminum electrolytic capacitor and 1  $\mu$ F ceramic capacitor on the output. See application circuit.  
 2. Measured at 230 Vac.  
 3. All specifications are measured at Ta=25°C, humidity <75%, nominal input voltage, and rated output load unless otherwise specified.

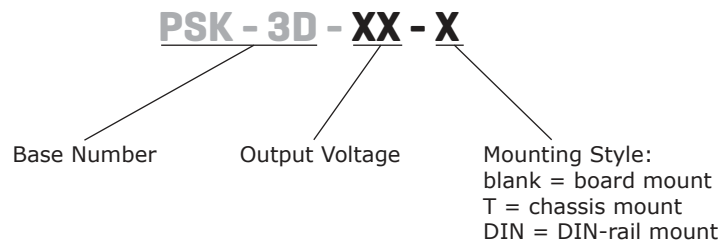
**PART NUMBER KEY**

## INPUT

parameter	conditions/description	min	typ	max	units
voltage	ac input	85		305	Vac
	dc input	100		430	Vdc
frequency		47		63	Hz
current	at 115 Vac			0.08	A
	at 230 Vac			0.06	A
inrush current	at 115 Vac		15		A
	at 230 Vac		25		A
leakage current	277 Vac/50 Hz			0.25	mA

## OUTPUT

parameter	conditions/description	min	typ	max	units
capacitive load	3.3 Vdc output model			4,000	μF
	5 Vdc output model			3,000	μF
	9 Vdc output model			1,200	μF
	12 Vdc output model			1,200	μF
	15 Vdc output model			680	μF
	24 Vdc output model			220	μF
output voltage accuracy	3.3 Vdc output model		±3		%
	all other output models		±2		%
line regulation	at full load		±0.5		%
load regulation	0~100% load		±1.0		%
hold-up time	at 115 Vac		5		ms
	at 230 Vac		50		ms
switching frequency			65		kHz
no load power consumption	at 230 Vac				
	5 Vdc & 12 Vdc output models all other output models		0.2 0.1		W W

## PROTECTIONS

parameter	conditions/description	min	typ	max	units
over voltage protection	3.3 & 5 Vdc output models			7.5	V
	9 Vdc output model			15	V
	12 Vdc output model			16	V
	15 Vdc output model			20	V
	24 Vdc output model			30	V
over current protection	auto recovery			200	%
short circuit protection	continuous, auto recovery, hiccup				

## SAFETY & COMPLIANCE

parameter	conditions/description	min	typ	max	units
isolation voltage	input to output, 1 min. <5mA	4,000			Vac
safety approvals	certified to 62368: IEC, EN, UL/cUL				
	certified to 61558: EN				
	certified to 60335: EN				
safety class	Class II				
EMI/EMC	CISPR32/EN55032 CLASS B EN55014-1				
ESD	IEC/EN 61000-4-2 Contact ±6KV/Air ±8KV perf. Criteria B EN55014-2 perf. Criteria B				
radiated immunity	IEC/EN61000-4-3 10V/m perf. Criteria A EN55014-2 perf. Criteria A				

## SAFETY & COMPLIANCE

EFT/burst	IEC/EN61000-4-4 ±2KV (See Fig.1 for typical application circuit) perf. Criteria B IEC/EN61000-4-4 ±4KV (See Fig.2 for recommended circuit) perf. Criteria B EN55014-2 perf. Criteria B		
surge	IEC/EN61000-4-5 line to line ±1KV (See Fig.1 for typical application circuit) perf. Criteria B IEC/EN61000-4-5 line to line ±2KV (See Fig.2 for recommended circuit) perf. Criteria B EN55014-2 perf. Criteria B		
conducted immunity	IEC/EN61000-4-6 10Vr.m.s perf. Criteria A EN55014-2 perf. Criteria A		
voltage dips and interruption	IEC/EN61000-4-11 0%, 70% perf. Criteria B EN55014-2 perf. Criteria B		
MTBF	MIL-HDBK-217F at 25°C	2,799,000	hours
RoHS	yes		

## ENVIRONMENTAL

parameter	conditions/description	min	typ	max	units
operating temperature		-40		85	°C
storage temperature		-40		105	°C
storage humidity		0		95	%

## SOLDERABILITY

parameter	conditions/description	min	typ	max	units
wave soldering	5~10 seconds max	255	260	265	°C
hand soldering	3~5 seconds max	350	360	370	°C

## MECHANICAL

parameter	conditions/description	min	typ	max	units
dimensions	horizontal package: 25.40 x 25.40 x 17.60				mm
	chassis mount: 76.00 x 31.50 x 26.40				mm
	DIN-rail: 76.00 x 31.50 x 31.00				mm
weight	horizontal package, 3.3 Vdc, 5 Vdc, 9 Vdc & 12 Vdc output		18.0		g
	horizontal package, 15 Vdc & 24 Vdc output		18.5		g
	chassis mount		38.0		g
	DIN-rail		58.0		g
case material	Black plastic, flame-retardant and heat-resistant (UL94V-0)				

## MECHANICAL DRAWING

units: mm [inch]  
 pin diameter tolerance:  $\pm 0.10$  [ $\pm 0.004$ ]  
 tolerance:  $\pm 0.50$  [ $\pm 0.020$ ]

PIN CONNECTIONS	
PIN	Function
1	AC(N)
2	AC(L)
3	no pin
4	-Vo
5	+Vo

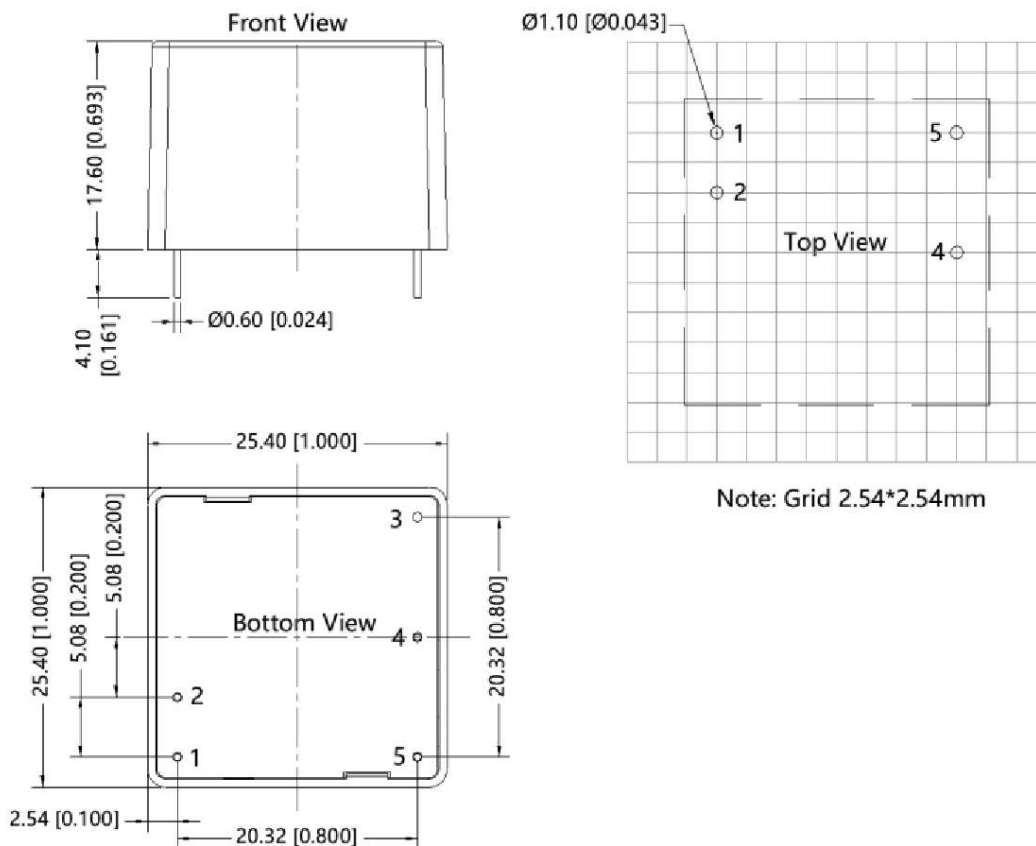

## MECHANICAL DRAWING

units: mm [inch]  
 wire range: 24~12 AWG  
 tightening torque: Max 0.4 N·m  
 tolerance: ±1.0 [±0.039]

PIN CONNECTIONS	
PIN	Function
1	AC(N)
2	AC(L)
3	-Vo
4	+Vo

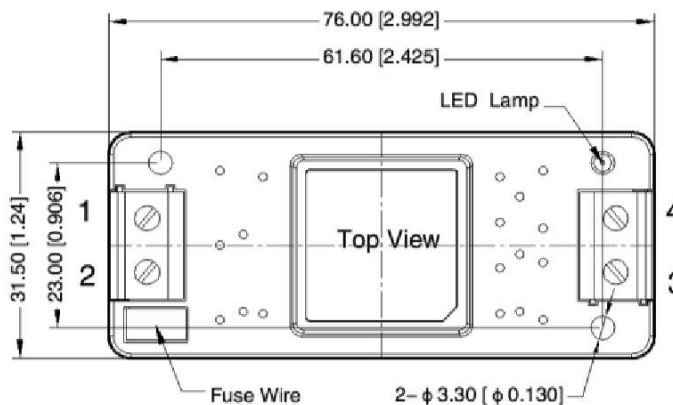

units: mm [inch]  
 wire range: 24~12 AWG  
 tightening torque: Max 0.4 N·m  
 mounting rail: TS35, must be connected to safety ground  
 tolerance: ±1.0 [±0.039]

PIN CONNECTIONS	
PIN	Function
1	AC(N)
2	AC(L)
3	-Vo
4	+Vo

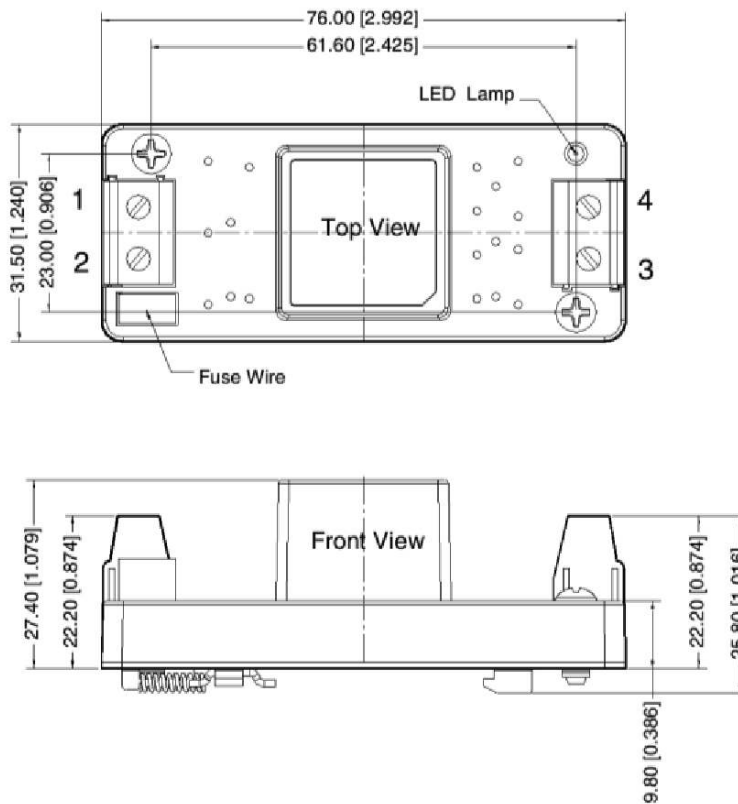

## APPLICATION DESIGN REFERENCE

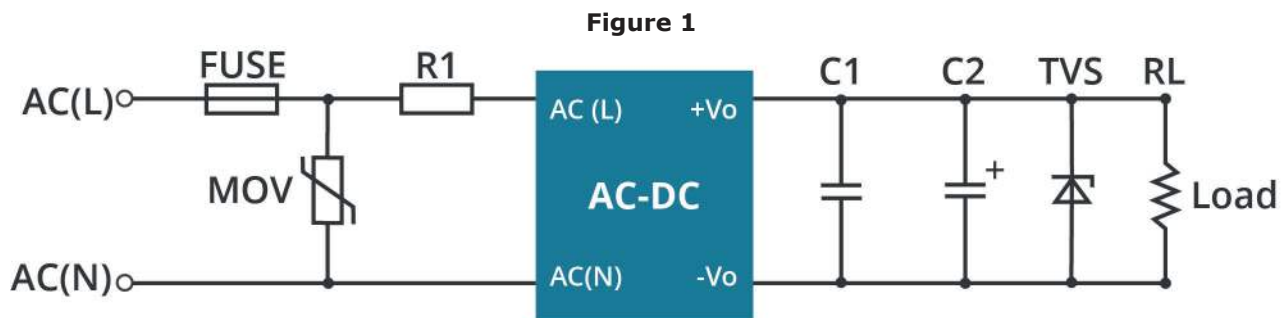

**Table 1**

Part No.	C1(μF)	C2(μF)	FUSE	R1	TVS	MOV
PSK-3D-3	1	150	1A/300V, slow-blow, required	12Ω/3W	SMBJ7A	S10K350
PSK-3D-5		150			SMBJ7A	
PSK-3D-9		120			SMBJ12A	
PSK-3D-12		120			SMBJ20A	
PSK-3D-15		120			SMBJ20A	
PSK-3D-24		68			SMBJ30A	

### Output Filtering Components:

An electrolytic capacitor with high frequency operation, low ESR, and at least 20% margin on rated output voltage is recommended for C2. C1 should be a ceramic capacitor and the TVS will help protect downstream electronics in the unlikely event of converter failure.

## EMC RECOMMENDED CIRCUIT

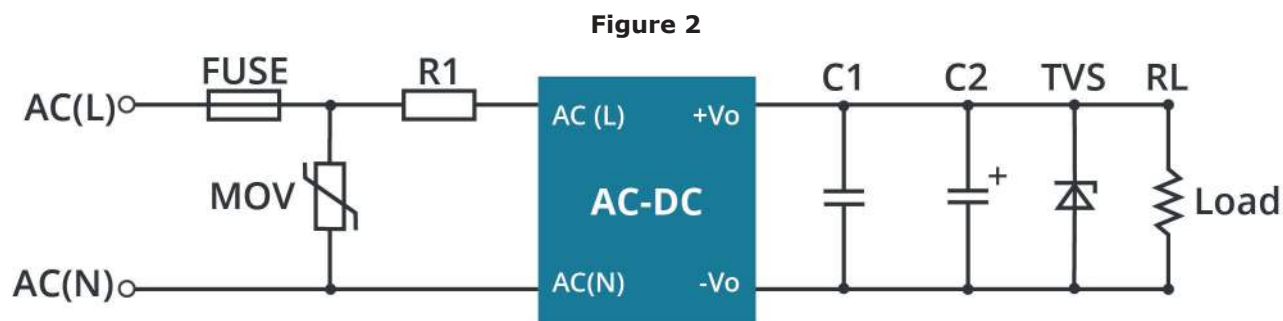

Note: EMC application circuit with higher requirements.

**Table 2**

Components	Recommended Value
MOV	S14K350
R1	33Ω/3W
FUSE	2A/300V, slow-blow, required

## DERATING CURVE

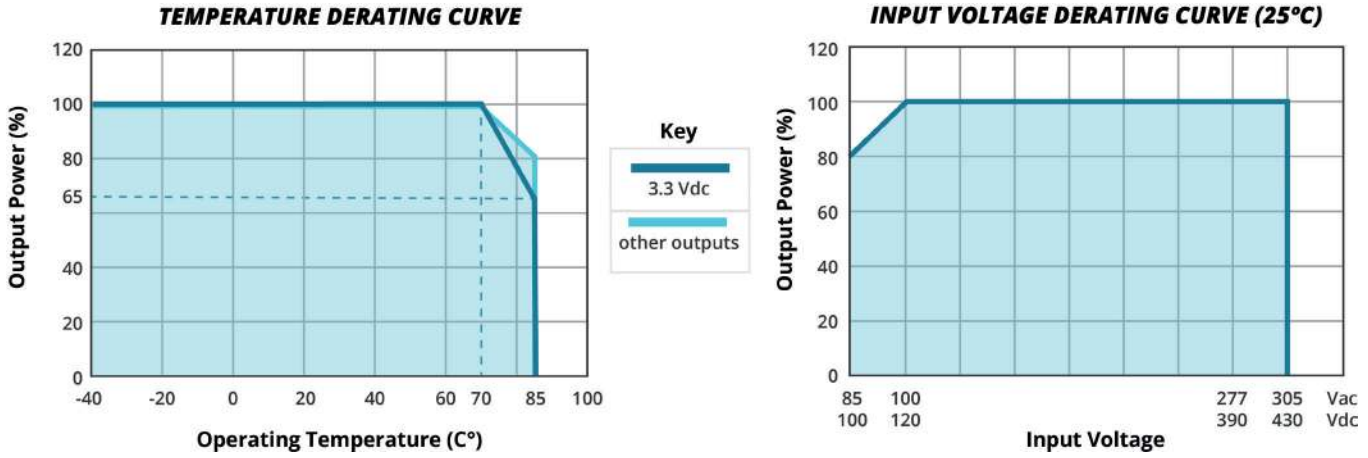

Note: 1. With an AC input between 85~100Vac and DC input between 100~120Vdc, the output power must be derated as per temperature derating curves.  
 2. This product is suitable for applications using natural air cooling; for applications in closed environment please consult with CUI.

## EFFICIENCY CURVES

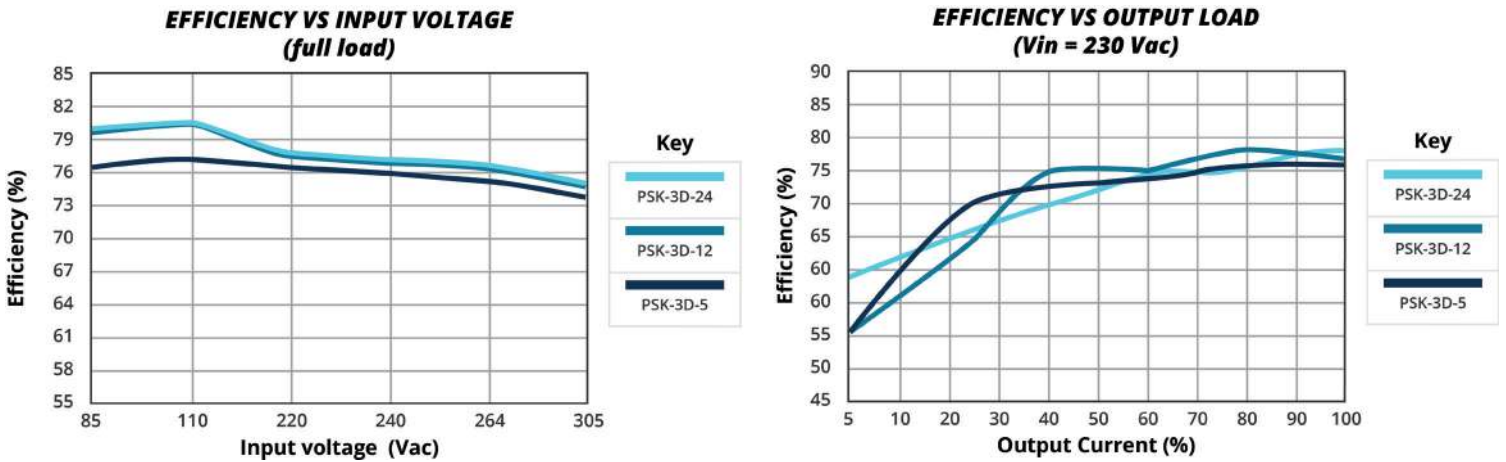

## REVISION HISTORY

---

rev.	description	date
1.0	initial release	01/28/2021
1.01	derating curves updated	01/19/2022
1.02	no load power consumption updated	05/03/2022
1.03	UKCA mark added	06/13/2022

The revision history provided is for informational purposes only and is believed to be accurate.



**Headquarters**  
20050 SW 112th Ave.  
Tualatin, OR 97062  
**800.275.4899**

Fax 503.612.2383  
**cuicom**  
techsupport@cuicom

CUI offers a two (2) year limited warranty. Complete warranty information is listed on our website.

CUI reserves the right to make changes to the product at any time without notice. Information provided by CUI is believed to be accurate and reliable. However, no responsibility is assumed by CUI for its use, nor for any infringements of patents or other rights of third parties which may result from its use.

CUI products are not authorized or warranted for use as critical components in equipment that requires an extremely high level of reliability. A critical component is any component of a life support device or system whose failure to perform can be reasonably expected to cause the failure of the life support device or system, or to affect its safety or effectiveness.