

Click to
ORDER
samples

AMSRU-78JZ



Aimtec introduces the new AMSRU-78JZ, a 0.5A Switching Regulator which is designed to be a plug and play alternative to the traditional 78xx series three-terminal linear regulators.

The series features an ultra-wide input voltage range of 9-90V, 1.5mA low no load input current, continuous short-circuit protection, low ripple noise (typ.: 40mV) and much more.

The new AMSRU-78JZ series has operating temperature from -40°C to +85°C, has delivers efficiencies up to 93%, eliminating the need for a heat sink and cutting additional design space and installation cost. This series is suitable for use in applications such as industrial controls, medical, mining, railway and other related industries.

Features

- Input Range: 9VDC – 90VDC
- Operating Temp: -40 °C to +85 °C
- Low ripple & noise, up to 40mV(p-p) typ.
- Efficiency up to 93%
- Output short circuit protection
- Regulated Output

Summary

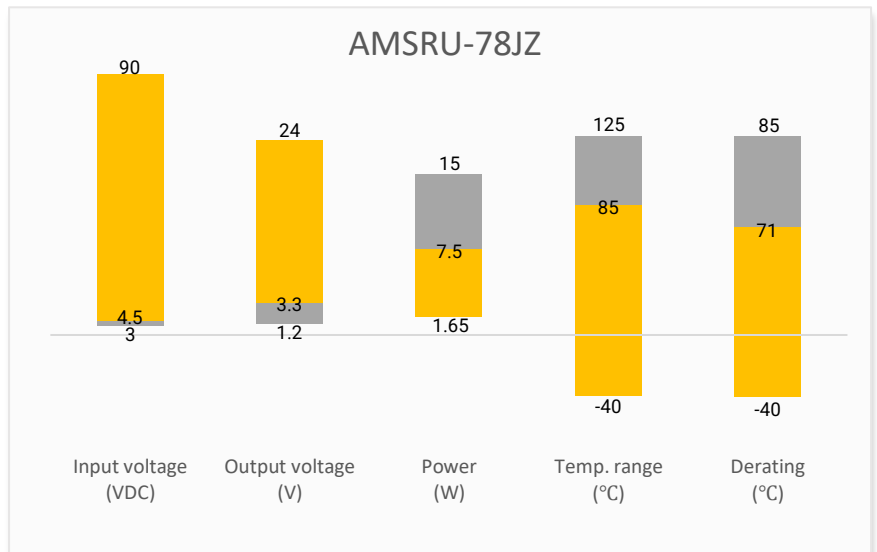

Training

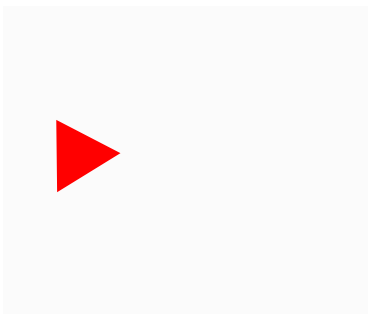

Product Training Video
(click to open)

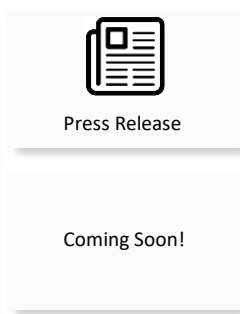

Application Notes

Applications



IoT



Industrial



Portable Equipment



Telecommunication

Models & Specifications

Single Output					
Model	Input Voltage (VDC)	Output Voltage (VDC)	Output Current Max (mA)	Maximum Capacitive Load (μF)	Efficiency (%) Full Load
AMSRU-7803JZ	48 (9 ~ 90)	3.3	500	100	82
AMSRU-7805JZ	48 (9 ~ 90)	5	500	100	87
AMSRU-7806JZ	48 (9 ~ 90)	6.5	500	100	91
AMSRU-7809JZ	48 (14 ~ 90)	9	500	100	91
AMSRU-7812JZ	48 (18 ~ 90)	12	500	100	91
AMSRU-7815JZ	48 (20 ~ 90)	15	500	100	93
AMSRU-7824JZ	48 (36 ~ 90)	24	300	100	93
AMSRU-7803LJZ	48 (9 ~ 90)	3.3	500	100	82
AMSRU-7805LJZ	48 (9 ~ 90)	5	500	100	87
AMSRU-7806LJZ	48 (9 ~ 90)	6.5	500	100	91
AMSRU-7809LJZ	48 (14 ~ 90)	9	500	100	91
AMSRU-7812LJZ	48 (18 ~ 90)	12	500	100	91
AMSRU-7815LJZ	48 (20 ~ 90)	15	500	100	93
AMSRU-7824LJZ	48 (36 ~ 90)	24	300	100	93

Note: Adding a letter of "L" for L models with right angled leads. Ex: AMSRU-78xxLJZ

Input Specification				
Parameters	Conditions	Typical	Maximum	Units
Voltage range	See models table			VDC
No load input current			1.5	mA
Filter	Capacitance filter			
Reverse polarity at input	Avoid / Not protected			

Output Specification				
Parameters	Conditions	Typical	Maximum	Units
Voltage accuracy	10 ~ 100% input, 3.3V output model	± 3.5	± 4.5	%
	10 ~ 100% input, Others	± 2.0	± 3	%
Line regulation	Full load, 3.3V output model	± 0.6	± 1.5	%
	Full load, Others	± 0.6	± 1.2	%
Load regulation	10 ~ 100% load	± 1.0	± 2.0	%
Short circuit protection	Continuous, Auto recovery			
Temperature coefficient			± 0.03	%/°C
Ripple & Noise*	20MHz bandwidth, full load	40	80	mV pk-pk
Transient recovery time	25% load step change	200	1000	μS
Transient response deviation	25% load step change	± 0.4	± 1.5	%

General Specifications				
Parameters	Conditions	Typical	Maximum	Units
Switching frequency *	Full load	300		KHz
Operating temperature	See derating graph	-40 to +85		°C
Storage temperature		-55 to +125		°C
Pin soldering temperature	Soldering spot is 1.5mm away from case, 10 sec max		300	°C
Cooling	Free air convection			
Humidity	Non-condensing		95	% RH
Case material	Non-conductive black plastic (UL94V-0 rated)			
Weight		3.8		g
Dimensions (L x W x H)		0.45 x 0.35 x 0.69 inches, 11.50 x 9.00 x 17.50mm		
	L models	0.75 x 0.45 x 0.35 inches, 19.00 x 11.50 x 9.00mm		
MTBF	> 2 000 000 hrs (MIL-HDBK -217F, t=+25°C) / Full Load			

*Different output voltage with different switching frequency.

Safety Specifications		
Parameters		
Standards	EMC - Conducted and radiated emission	CISPR32/EN55032, CLASS B with EMI recommended circuit
	Electrostatic Discharge Immunity	IEC 61000-4-2, Contact ±4KV, Criteria B
	RF, Electromagnetic Field Immunity	IEC 61000-4-3, 10V/m, Criteria B
	Electrical Fast Transient/Burst Immunity	IEC 61000-4-4, 100KHz, ±1KV, Criteria B with EMS recommended circuit
	Surge Immunity	IEC 61000-4-5, line to line ±1KV, Criteria B with EMS recommended circuit
	RF, Conducted Disturbance Immunity	IEC 61000-4-6, 3Vr.m.s, Criteria B

Derating

For 24V output model($V_{in}:36\sim60V$)
Others model normally V_{in}

For 24V output model($V_{in} \geq 60V$)

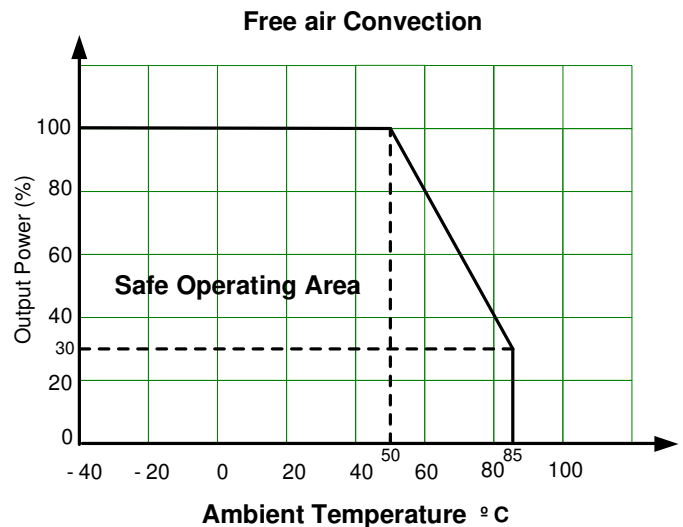
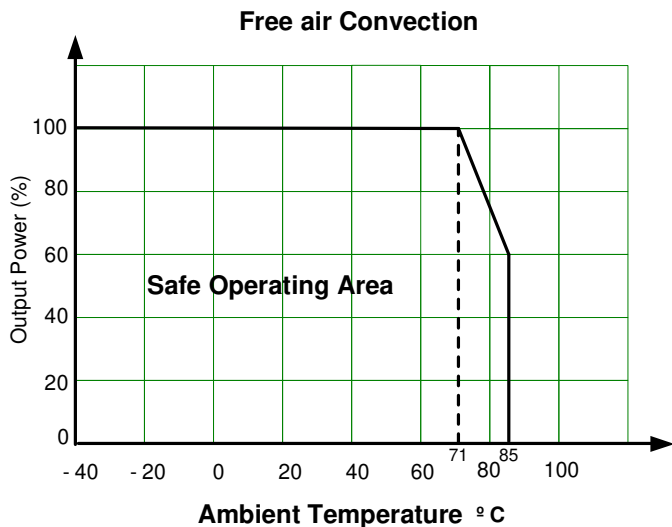

Typical Application Circuit

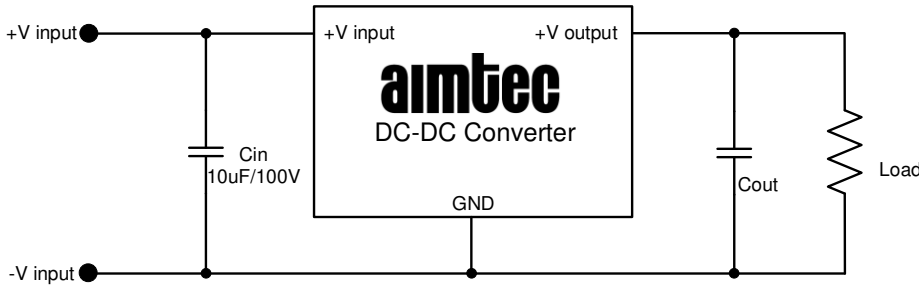

Model	C_{out}
3.3V/5V/6.5V output	22 μ F / 10V
9V output	22 μ F / 16V
12V/15V output	22 μ F / 25V
24V output	10 μ F / 50V

- Note :**
- For input voltage exceeding 80Vdc, an input capacitor of 22 μ F/100V is required.
 - For certain applications, increased values and/or tantalum or low ESR electrolytic capacitors may also be used instead.

EMC Recommended Circuit

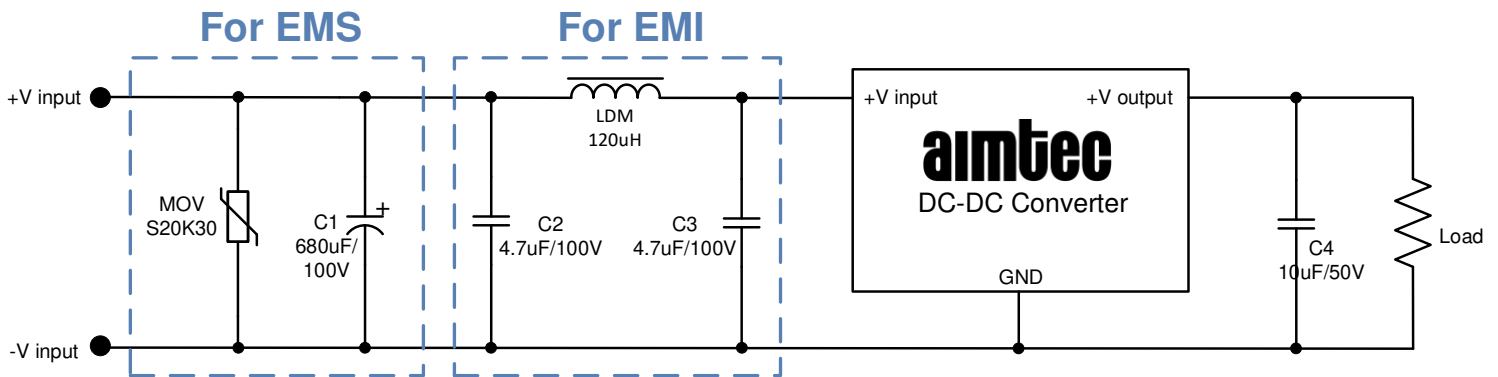

Dimensions

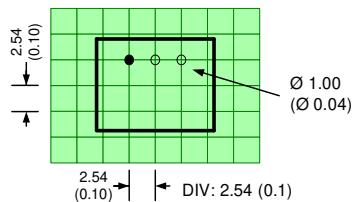
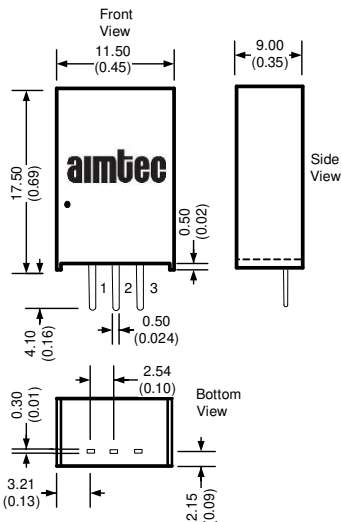

Dimensions are typical values: mm (inch)
General Tolerance: ± 0.50 (± 0.02)
Pin Tolerance: ± 0.1 (± 0.004)

Pin Out Specifications	
Pin	Function
1	+V Input
2	GND
3	+V Output

L Models

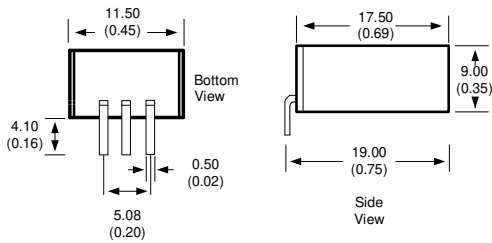

Footprint

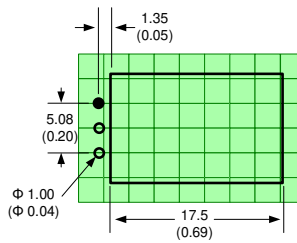

Dimensions are typical values: mm (inch)
General Tolerance: ± 0.50 (± 0.02)
Pin Tolerance: ± 0.1 (± 0.004)

Pin Out Specifications

Pin	Function
1	+V Input
2	GND
3	+V Output

NOTE: 1. Datasheets are updated as needed and as such, specifications are subject to change without notice. Once printed or downloaded, datasheets are no longer controlled by Aimtec; refer to www.aimtec.com for the most current product specifications. 2. Product labels shown, including safety agency certifications on labels, may vary based on the date manufactured. 3. Mechanical drawings and specifications are for reference only. 4. All specifications are measured at an ambient temperature of 25°C, humidity<75%, nominal input voltage and at rated output load unless otherwise specified. 5. Aimtec may not have conducted destructive testing or chemical analysis on all internal components and chemicals at the time of publishing this document. CAS numbers and other limited information are considered proprietary and may not be available for release. 6. This product is not designed for use in critical life support systems, equipment used in hazardous environments, nuclear control systems or other such applications which necessitate specific safety and regulatory standards other the ones listed in this datasheet. 7. Warranty is in accordance with Aimtec's standard Terms of Sale available at www.aimtec.com.