

1-180908-0 ✓ ACTIVE

FASTIN-FASTON | FASTIN-FASTON 250

TE Internal #: 1-180908-0

Crimp Terminal Housings, Tab, Tab Housing, 2 Position, Straight, Natural, Polyamide, Contact Mating Retention, Mating Alignment, FASTIN-FASTON 250

[View on TE.com >](#)



Terminals & Splices > Terminal Housings, Insulation Sleeves & Blocks > Crimp Terminal Housings

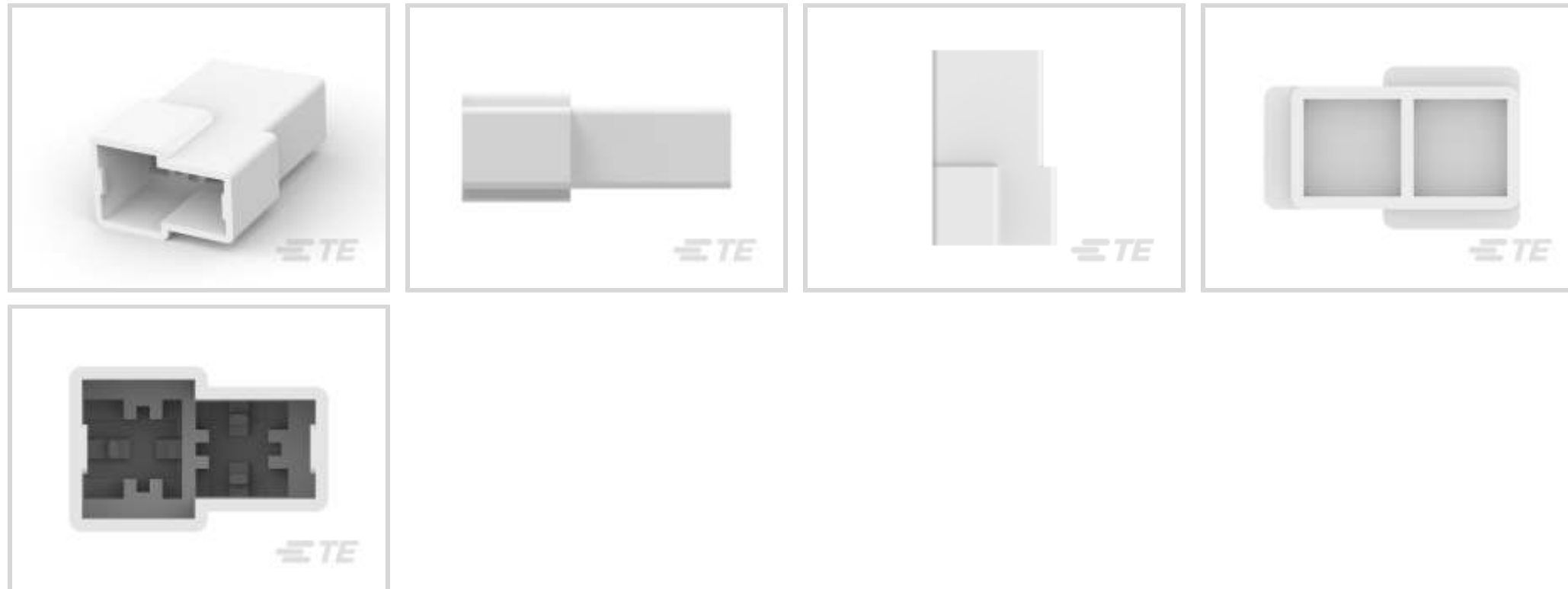

Terminal Type: **Tab**

Connector & Housing Type: **Tab Housing**

Number of Positions: **2**

Terminal Orientation: **Straight**

Primary Product Color: **Natural**

## Features

### Product Type Features

Sealable	No
Connector & Contact Terminates To	Wire & Cable
Connector & Housing Type	Tab Housing

### Configuration Features

Number of Positions	2
---------------------	---

### Body Features

Primary Product Color	Natural
-----------------------	---------

### Contact Features

Terminal Type	Tab
Terminal Orientation	Straight
Contact Mating Retention	With

### Mechanical Attachment

Mating Alignment	With
------------------	------



Connector Mounting Type

Cable Mount (Free-Hanging)

### Housing Features

Housing Material

Polyamide

Centerline (Pitch)

7.4 mm[.291 in]

### Dimensions

Product Length

31.5 mm[1.24 in]

### Usage Conditions

Operating Temperature Range

-40 – 105 °C[-40 – 221 °F]

### Packaging Features

Packaging Quantity

3000

Packaging Method

Carton

## Product Compliance

For compliance documentation, visit the product page on [TE.com](https://www.te.com)>

EU RoHS Directive 2011/65/EU

Compliant

EU ELV Directive 2000/53/EC

Compliant

China RoHS 2 Directive MIIT Order No 32, 2016

No Restricted Materials Above Threshold

EU REACH Regulation (EC) No. 1907/2006

Current ECHA Candidate List: JUNE 2023 (235)  
Candidate List Declared Against: JAN 2023 (233)  
Does not contain REACH SVHC

Halogen Content

Low Halogen - Br, Cl, F, I < 900 ppm per homogenous material. Also BFR/CFR/PVC Free

Solder Process Capability

Not applicable for solder process capability

#### Product Compliance Disclaimer

This information is provided based on reasonable inquiry of our suppliers and represents our current actual knowledge based on the information they provided. This information is subject to change. The part numbers that TE has identified as EU RoHS compliant have a maximum concentration of 0.1% by weight in homogenous materials for lead, hexavalent chromium, mercury, PBB, PBDE, DBP, BBP, DEHP, DIBP, and 0.01% for cadmium, or qualify for an exemption to these limits as defined in the Annexes of Directive 2011/65/EU (RoHS2). Finished electrical and electronic equipment products will be CE marked as required by Directive 2011/65/EU. Components may not be CE marked. Additionally, the part numbers that TE has identified as EU ELV compliant have a maximum concentration of 0.1% by weight in homogenous materials for lead, hexavalent chromium, and mercury, and 0.01% for cadmium, or qualify for an exemption to these limits as defined in the Annexes of Directive 2000/53/EC (ELV). Regarding the REACH Regulation, the information TE provides on SVHC in articles for this part number is based on the latest European Chemicals Agency (ECHA) 'Guidance on requirements for substances in articles' posted at this URL: <https://echa.europa.eu/guidance-documents/guidance-on-reach>



## Compatible Parts



TE Part # 170340-1  
FF 250 TAB 20-14AWG BR WITHOUT LATCH



TE Part # 170341-3  
FF 250 TAB 14-12AWG PTBR WITHOUT LATCH



TE Part # 170349-2  
FF 250 TAB 22-20AWG TPBR WITHOUT LATCH



TE Part # 170340-3  
FF 250 TAB 20-14AWG PTBR WITHOUT LATCH



TE Part # 170341-1  
FF 250 TAB 14-12AWG BR WITHOUT LATCH



TE Part # 1-626065-2  
FF 110 2P HOUSING TAB NATURAL PA6.6 V-0



TE Part # 626065-5  
HOUSING 2P .110 FASTIN-ON TAB



TE Part # 170349-1  
FF 250 TAB 22-20AWG BR WITHOUT LATCH



TE Part # 1-180907-6  
FF 250 REC HSG 2P NYLON NAT



TE Part # 9-144836-5  
DOUBLE LOCKING 5 MM HOUSING TAB PA66

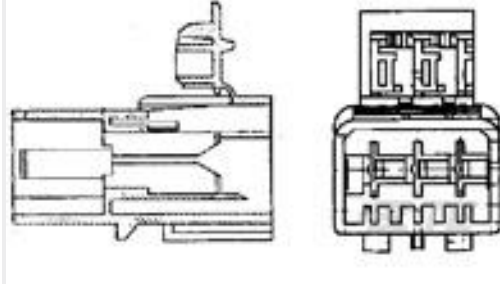

TE Part # 1-144836-5  
HOUSING TAB 5MM 5 P BROWN



TE Part # 180908-3  
FF 250 TAB HSG 2P NYLON BLUE



TE Part # 5-144835-3  
HOUSING TAB 5MM 3 P GREEN



TE Part # 6-316441-6  
FF 187 PLUG 8P ASSY LIGHT GRAY



TE Part # 927357-1  
FF 110 2P HOUSING PA66 NATURAL



TE Part # 927670-1  
FF 203 TAB HSG 16P NYLON NAT

## Also in the Series | FASTIN-FASTON 250

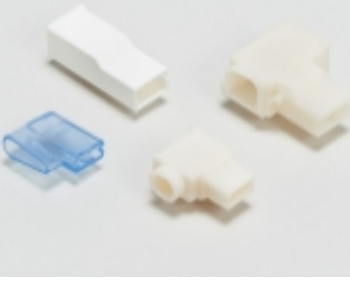

Crimp Terminal Housings(211)



Insertion & Extraction Tools(2)



PCB Terminals(2)

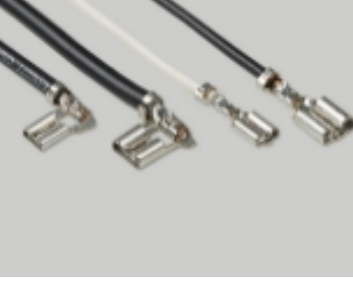

Quick Disconnects(254)

## Customers Also Bought



TE Part #1-962340-1  
4P FLACHSTCK GEH2,8



TE Part #160691-2  
FF 250 TAB 22-18AWG TPBR

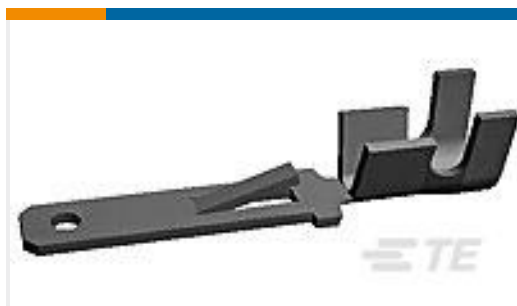

TE Part #42460-2  
FF 250 TAB 18-14AWG TPBR



TE Part #5-160555-2  
110 FASTON REC 20-18 AWG TPBR



TE Part #928931-1  
FF 110 (2.8 X 0.8 MM) TAB SSP  
CUZN30

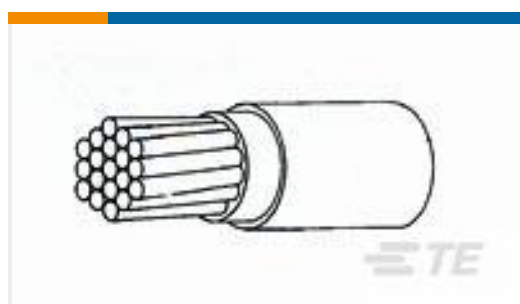

TE Part #2813813003  
44/7031-20-0



TE Part #1740205-2  
AMPMODU II CONTACT PIN, BENT,  
TIN

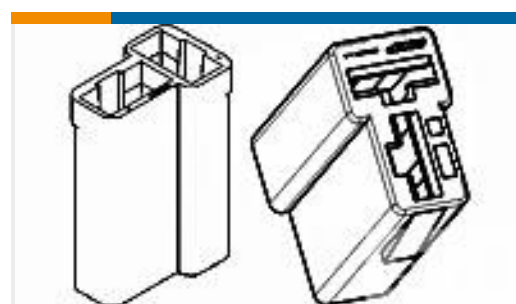

TE Part #1-180907-0  
FF 250 REC HSG 2P NYLON NAT



TE Part #6-568176-3  
CRIMPER, WIRE (.039" 'F')

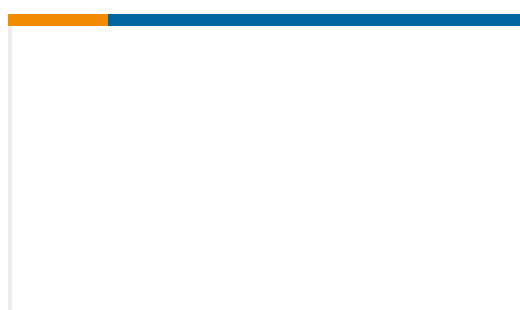

TE Part #7-523649-0  
GRIPPER STANDARD

## Documents

### Product Drawings

[FF 250 TAB HSG 2P NYLON NAT](#)

English

### CAD Files

Customer View Model

[ENG\\_CVM\\_CVM\\_1-180908-0\\_AB.2d\\_dxf.zip](#)

English

### 3D PDF

3D

Customer View Model

[ENG\\_CVM\\_CVM\\_1-180908-0\\_AB.3d\\_igs.zip](#)

English

Customer View Model

[ENG\\_CVM\\_CVM\\_1-180908-0\\_AB.3d\\_stp.zip](#)

English

By downloading the CAD file I accept and agree to the [Terms and Conditions](#) of use.



### Datasheets & Catalog Pages

[White Paper: Nylon Discoloration](#)

English

---

### Product Specifications

[Application Specification](#)

English

---

### Product Environmental Compliance

[MD\\_1-180908-0\\_03032018748\\_dmtec](#)

English

[MD\\_1-180908-0\\_03032018748\\_dmtec](#)

English

---

### Agency Approvals

[UL Report](#)

English