



Is Now Part of



**ON Semiconductor®**

To learn more about ON Semiconductor, please visit our website at  
[www.onsemi.com](http://www.onsemi.com)

Please note: As part of the Fairchild Semiconductor integration, some of the Fairchild orderable part numbers will need to change in order to meet ON Semiconductor's system requirements. Since the ON Semiconductor product management systems do not have the ability to manage part nomenclature that utilizes an underscore (\_), the underscore (\_) in the Fairchild part numbers will be changed to a dash (-). This document may contain device numbers with an underscore (\_). Please check the ON Semiconductor website to verify the updated device numbers. The most current and up-to-date ordering information can be found at [www.onsemi.com](http://www.onsemi.com). Please email any questions regarding the system integration to [Fairchild\\_questions@onsemi.com](mailto:Fairchild_questions@onsemi.com).

ON Semiconductor and the ON Semiconductor logo are trademarks of Semiconductor Components Industries, LLC dba ON Semiconductor or its subsidiaries in the United States and/or other countries. ON Semiconductor owns the rights to a number of patents, trademarks, copyrights, trade secrets, and other intellectual property. A listing of ON Semiconductor's product/patent coverage may be accessed at [www.onsemi.com/site/pdf/Patent-Marking.pdf](http://www.onsemi.com/site/pdf/Patent-Marking.pdf). ON Semiconductor reserves the right to make changes without further notice to any products herein. ON Semiconductor makes no warranty, representation or guarantee regarding the suitability of its products for any particular purpose, nor does ON Semiconductor assume any liability arising out of the application or use of any product or circuit, and specifically disclaims any and all liability, including without limitation special, consequential or incidental damages. Buyer is responsible for its products and applications using ON Semiconductor products, including compliance with all laws, regulations and safety requirements or standards, regardless of any support or applications information provided by ON Semiconductor. "Typical" parameters which may be provided in ON Semiconductor data sheets and/or specifications can and do vary in different applications and actual performance may vary over time. All operating parameters, including "Typicals" must be validated for each customer application by customer's technical experts. ON Semiconductor does not convey any license under its patent rights nor the rights of others. ON Semiconductor products are not designed, intended, or authorized for use as a critical component in life support systems or any FDA Class 3 medical devices or medical devices with a same or similar classification in a foreign jurisdiction or any devices intended for implantation in the human body. Should Buyer purchase or use ON Semiconductor products for any such unintended or unauthorized application, Buyer shall indemnify and hold ON Semiconductor and its officers, employees, subsidiaries, affiliates, and distributors harmless against all claims, costs, damages, and expenses, and reasonable attorney fees arising out of, directly or indirectly, any claim of personal injury or death associated with such unintended or unauthorized use, even if such claim alleges that ON Semiconductor was negligent regarding the design or manufacture of the part. ON Semiconductor is an Equal Opportunity/Affirmative Action Employer. This literature is subject to all applicable copyright laws and is not for resale in any manner.



November 2014

# KA324 / KA324A / KA2902 Quad Operational Amplifier

## Features

- Internally Frequency Compensated for Unity Gain
- Large DC Voltage Gain: 100 dB
- Wide Power Supply Range:  
KA324 / KA324A: 3 V ~ 32 V (or  $\pm 1.5$  V ~ 16 V)  
KA2902: 3 V ~ 26 V (or  $\pm 1.5$  V ~ 13 V)
- Input Common Mode Voltage Range Includes Ground
- Large Output Voltage Swing: 0 V to  $V_{CC} - 1.5$  V
- Power Drain Suitable for Battery Operation

## Description

The KA324 series consist of four independent, high gain, internally frequency compensated operational amplifiers which were designed specifically to operate from a single power supply over a wide voltage range. Operation from split power supplies is also possible so long as the difference between the two supplies is 3 V to 32 V. Application areas include transducer amplifier, DC gain blocks and all the conventional OP Amp circuits which now can be easily implemented in single power supply systems.

14-DIP



14-SOP

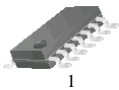

## Ordering Information

Part Number	Operating Temperature Range	Top Mark	Package	Packing Method
KA324	0 to +70°C	KA324	MDIP 14L	Rail
KA324A		KA324A	MDIP 14L	Rail
KA324DTF		KA324D	SOP 14L	Tape and Reel
KA324ADTF		KA324AD	SOP 14L	Tape and Reel
KA2902DTF	-40 to +85°C	KA2902D	SOP 14L	Tape and Reel

### Block Diagram

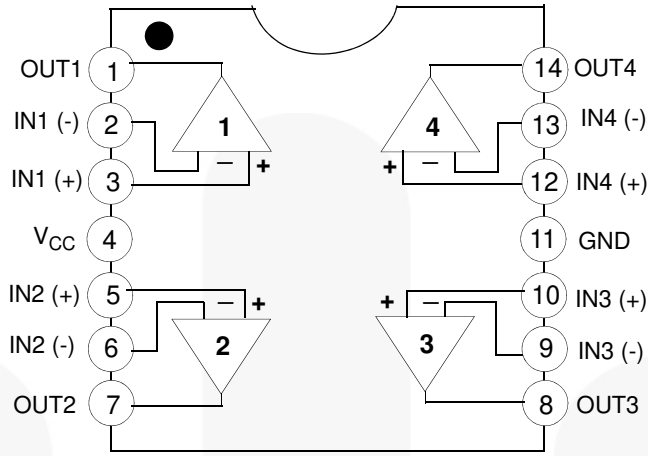

Figure 1. Block Diagram

### Schematic Diagram

(One Section Only)

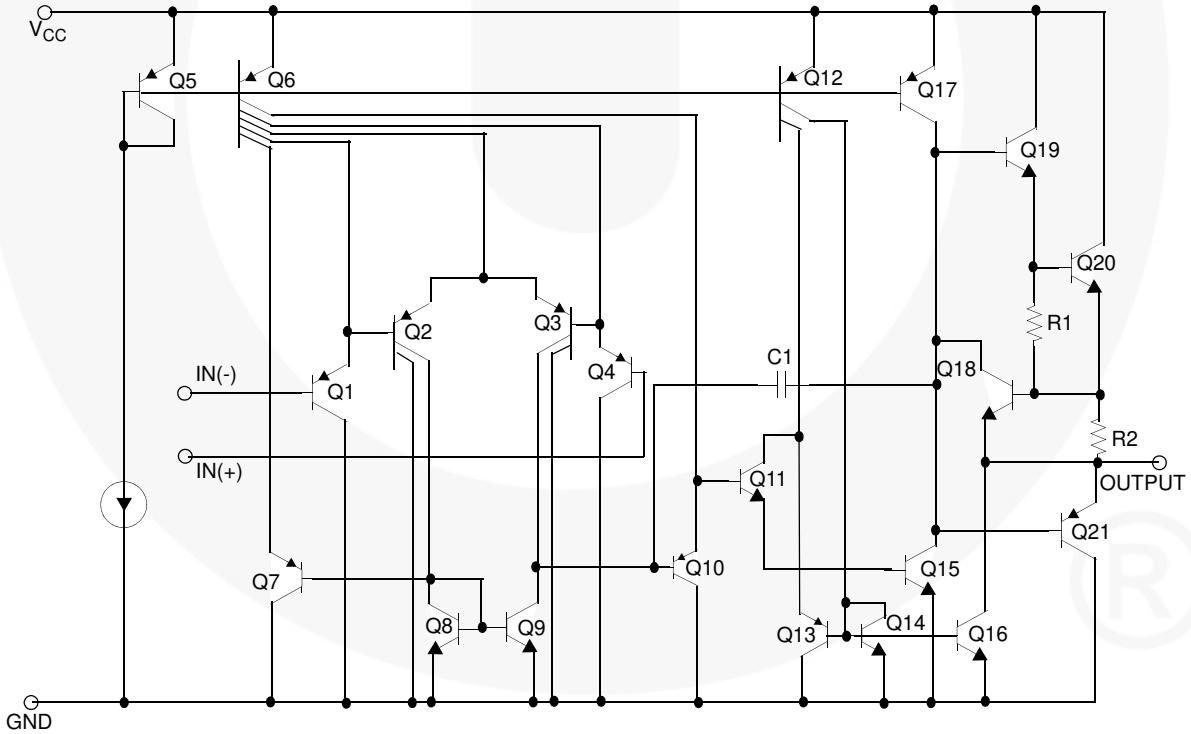

Figure 2. Schematic Diagram

## Absolute Maximum Ratings

Stresses exceeding the absolute maximum ratings may damage the device. The device may not function or be operable above the recommended operating conditions and stressing the parts to these levels is not recommended. In addition, extended exposure to stresses above the recommended operating conditions may affect device reliability. The absolute maximum ratings are stress ratings only. Values are at  $T_A = 25^\circ\text{C}$  unless otherwise noted.

Parameter	Symbol	KA324 / KA324A	KA2902	Unit
Power Supply Voltage	$V_{CC}$	$\pm 16$ or 32	$\pm 13$ or 26	V
Differential Input Voltage	$V_{I(DIFF)}$	32	26	V
Input Voltage	$V_I$	-0.3 to +32	-0.3 to +26	V
Output Short Circuit to GND $V_{CC} \dot{\iota} 15\text{ V}, T_A = 25^\circ\text{C}$ (One Amp)	-	Continuous	Continuous	-
Operating Temperature Range	$T_{OPR}$	0 to +70	-40 to +85	$^\circ\text{C}$
Storage Temperature Range	$T_{STG}$	-65 to +150	-65 to +150	$^\circ\text{C}$

## Thermal Characteristics

Values are at  $T_A = 25^\circ\text{C}$  unless otherwise noted.

Symbol	Parameter		Value	Unit
$P_D$	Power Dissipation, $T_A = 25^\circ\text{C}$	14-DIP	1310	mW
		14-SOP	640	
$R_{\theta JA}$	Thermal Resistance, Junction-to-Ambient, Max.	14-DIP	95	$^\circ\text{C}/\text{W}$
		14-SOP	195	

## Electrical Characteristics

Values are at  $V_{CC} = 5.0\text{ V}$ ,  $V_{EE} = \text{GND}$ ,  $T_A = 25^\circ\text{C}$ , unless otherwise specified.

Symbol	Parameter	Conditions	KA324			KA2902			Unit
			Min.	Typ.	Max.	Min.	Typ.	Max.	
$V_{IO}$	Input Offset Voltage	$V_{CM} = 0\text{ V}$ to $V_{CC} - 1.5\text{ V}$ , $V_{O(P)} = 1.4\text{ V}$ , $R_S = 0\ \Omega^{(1)}$	-	1.5	7.0	-	1.5	7.0	mV
$I_{IO}$	Input Offset Current	$V_{CM} = 0\text{ V}$	-	3	50	-	3	50	nA
$I_{BIAS}$	Input Bias Current	$V_{CM} = 0\text{ V}$	-	40	250	-	40	250	nA
$V_{I(R)}$	Input Common Mode Voltage Range	(1)	0	-	$V_{CC} - 1.5$	0	-	$V_{CC} - 1.5$	V
$I_{CC}$	Supply Current	$R_L = \infty$ , $V_{CC} = 30\text{ V}$ , (KA2902, $V_{CC} = 26\text{ V}$ )	-	1.0	3.0	-	1.0	3.0	mA
		$R_L = \infty$ , $V_{CC} = 5\text{ V}$	-	0.7	1.2	-	0.7	1.2	mA
$G_V$	Large Signal Voltage Gain	$V_{CC} = 15\text{ V}$ , $R_L = 2\text{ k}\Omega$ , $V_{O(P)} = 1\text{ V}$ to $11\text{ V}$	25	100	-	25	100	-	V/mV
$V_{O(H)}$	Output Voltage Swing	(1) $R_L = 2\text{ k}\Omega$	26	-	-	22	-	-	V
		$R_L = 10\text{ k}\Omega$	27	28	-	23	24	-	V
$V_{O(L)}$		$V_{CC} = 5\text{ V}$ , $R_L = 10\text{ k}\Omega$	-	5	20	-	5	100	mV
CMRR	Common-Mode Rejection Ratio	-	65	75	-	50	75	-	dB
PSRR	Power Supply Rejection Ratio	-	65	100	-	50	100	-	dB
CS	Channel Separation	$f = 1\text{ kHz}$ to $20\text{ kHz}^{(2)}$	-	120	-	-	120	-	dB
$I_{SC}$	Short Circuit to GND	$V_{CC} = 15\text{ V}$	-	40	60	-	40	60	mA
$I_{SOURCE}$	Output Current	$V_{I(+)} = 1\text{ V}$ , $V_{I(-)} = 0\text{ V}$ , $V_{CC} = 15\text{ V}$ , $V_{O(P)} = 2\text{ V}$	20	40	-	20	40	-	mA
$I_{SINK}$		$V_{I(+)} = 0\text{ V}$ , $V_{I(-)} = 1\text{ V}$ , $V_{CC} = 15\text{ V}$ , $V_{O(P)} = 2\text{ V}$	10	13	-	10	13	-	mA
		$V_{I(+)} = 0\text{ V}$ , $V_{I(-)} = 1\text{ V}$ , $V_{CC} = 15\text{ V}$ , $V_{O(R)} = 200\text{ mV}$	12	45	-	-	-	-	$\mu\text{A}$
$V_{I(DIFF)}$	Differential Input Voltage	-	-	-	$V_{CC}$	-	-	$V_{CC}$	V

### Notes:

- $V_{CC} = 30\text{ V}$  for KA324,  $V_{CC} = 26\text{ V}$  for KA2902.
- This parameter, although guaranteed is not 100% tested in production.

**Electrical Characteristics** (Continued)

Values are at  $V_{CC} = 5.0\text{ V}$ ,  $V_{EE} = \text{GND}$ , unless otherwise specified.

The following specification apply over the range of  $0^\circ\text{C} \leq T_A \leq +70^\circ\text{C}$  for the KA324, and the  $-40^\circ\text{C} \leq T_A \leq +85^\circ\text{C}$  for the KA2902.

Symbol	Parameter	Conditions	KA324			KA2902			Unit
			Min.	Typ.	Max.	Min.	Typ.	Max.	
$V_{IO}$	Input Offset Voltage	$V_{ICM} = 0\text{ V}$ to $V_{CC} - 1.5\text{ V}$ , $V_{O(P)} = 1.4\text{ V}$ , $R_S = 0\ \Omega$ <sup>(3)</sup>	-	-	9.0	-	-	10.0	mV
$\Delta V_{IO}/\Delta T$	Input Offset Voltage Drift	$R_S = 0\ \Omega$ <sup>(4)</sup>	-	7.0	-	-	7.0	-	$\mu\text{V}/^\circ\text{C}$
$I_{IO}$	Input Offset Current	$V_{CM} = 0\text{ V}$	-	-	150	-	-	200	nA
$\Delta I_{IO}/\Delta T$	Input Offset Current Drift	$R_S = 0\ \Omega$ <sup>(4)</sup>	-	10	-	-	10	-	$\text{pA}/^\circ\text{C}$
$I_{BIAS}$	Input Bias Current	$V_{CM} = 0\text{ V}$	-	-	500	-	-	500	nA
$V_{I(R)}$	Input Common Mode Voltage Range	(3)	0	-	$V_{CC} - 2.0$	0	-	$V_{CC} - 2.0$	V
$G_V$	Large Signal Voltage Gain	$V_{CC} = 15\text{ V}$ , $R_L = 2.0\text{ k}\Omega$ , $V_{O(P)} = 1\text{ V}$ to $11\text{ V}$	15	-	-	15	-	-	V/mV
$V_{O(H)}$	Output Voltage Swing	(3) $R_L = 2\text{ k}\Omega$	26	-	-	22	-	-	V
$V_{O(L)}$		$R_L = 10\text{ k}\Omega$	27	28	-	23	24	-	V
$V_{O(L)}$		$V_{CC} = 5\text{ V}$ , $R_L = 10\text{ k}\Omega$	-	5	20	-	5	100	mV
$I_{SOURCE}$	Output Current	$V_{I(+)} = 1\text{ V}$ , $V_{I(-)} = 0\text{ V}$ , $V_{CC} = 15\text{ V}$ , $V_{O(P)} = 2\text{ V}$	10	20	-	10	20	-	mA
$I_{SINK}$		$V_{I(+)} = 0\text{ V}$ , $V_{I(-)} = 1\text{ V}$ , $V_{CC} = 15\text{ V}$ , $V_{O(P)} = 2\text{ V}$	5	8	-	5	8	-	mA
$V_{I(DIFF)}$	Differential Input Voltage	-	-	-	$V_{CC}$	-	-	$V_{CC}$	V

**Notes:**

- $V_{CC} = 30\text{ V}$  for KA324,  $V_{CC} = 26\text{ V}$  for KA2902.
- These parameters, although guaranteed are not 100% tested in production.

**Electrical Characteristics** (Continued)Values are at  $V_{CC} = 5.0\text{ V}$ ,  $V_{EE} = \text{GND}$ ,  $T_A = 25^\circ\text{C}$ , unless otherwise specified.

Symbol	Parameter	Conditions	KA324A			Unit
			Min.	Typ.	Max.	
$V_{IO}$	Input Offset Voltage	$V_{CM} = 0\text{ V}$ to $V_{CC} - 1.5\text{ V}$ , $V_{O(P)} = 1.4\text{ V}$ , $R_S = 0\ \Omega$ <sup>(5)</sup>	-	1.5	3.0	mV
$I_{IO}$	Input Offset Current	$V_{CM} = 0\text{ V}$	-	3	30	nA
$I_{BIAS}$	Input Bias Current	$V_{CM} = 0\text{ V}$	-	40	100	nA
$V_{I(R)}$	Input Common-Mode Voltage Range	<sup>(5)</sup>	0	-	$V_{CC} - 1.5$	V
$I_{CC}$	Supply Current	$V_{CC} = 30\text{ V}$ , $R_L = \infty$	-	1.5	3.0	mA
		$V_{CC} = 5\text{ V}$ , $R_L = \infty$	-	0.7	1.2	mA
$G_V$	Large Signal Voltage Gain	$V_{CC} = 15\text{ V}$ , $R_L = 2\text{ k}\Omega$ , $V_{O(P)} = 1\text{ V}$ to $11\text{ V}$	25	100	-	V/mV
$V_{O(H)}$	Output Voltage Swing	<sup>(5)</sup> $R_L = 2\text{ k}\Omega$	26	-	-	V
		$R_L = 10\text{ k}\Omega$	27	28	-	V
$V_{O(L)}$		$V_{CC} = 5\text{ V}$ , $R_L = 10\text{ k}\Omega$	-	5	20	mV
CMRR	Common-Mode Rejection Ratio	-	65	85	-	dB
PSRR	Power Supply Rejection Ratio	-	65	100	-	dB
CS	Channel Separation	$f = 1\text{ kHz}$ to $20\text{ kHz}$ <sup>(6)</sup>	-	120	-	dB
$I_{SC}$	Short Circuit to GND	$V_{CC} = 15\text{ V}$	-	40	60	mA
$I_{SOURCE}$	Output Current	$V_{I(+)} = 1\text{ V}$ , $V_{I(-)} = 0\text{ V}$ , $V_{CC} = 15\text{ V}$ , $V_{O(P)} = 2\text{ V}$	20	40	-	mA
$I_{SINK}$		$V_{I(+)} = 0\text{ V}$ , $V_{I(-)} = 1\text{ V}$ , $V_{CC} = 15\text{ V}$ , $V_{O(P)} = 2\text{ V}$	10	20	-	mA
		$V_{I(+)} = 0\text{ V}$ , $V_{I(-)} = 1\text{ V}$ , $V_{CC} = 15\text{ V}$ , $V_{O(P)} = 200\text{ mV}$	12	50	-	$\mu\text{A}$
$V_{I(DIFF)}$	Differential Input Voltage	-	-	-	$V_{CC}$	V

**Notes:**5.  $V_{CC} = 30\text{ V}$  for KA324A.

6. This parameter, although guaranteed is not 100% tested in production.

**Electrical Characteristics** (Continued)

Values are at  $V_{CC} = 5.0\text{ V}$ ,  $V_{EE} = \text{GND}$ , unless otherwise specified.

The following specification apply over the range of  $0^\circ\text{C} \leq T_A \leq +70^\circ\text{C}$  for the KA324A.

Symbol	Parameter	Conditions	KA324A			Unit
			Min.	Typ.	Max.	
$V_{IO}$	Input Offset Voltage	$V_{CM} = 0\text{ V}$ to $V_{CC} - 1.5\text{ V}$ , $V_{O(P)} = 1.4\text{ V}$ , $R_S = 0\Omega$ <sup>(7)</sup>	-	-	5.0	mV
$\Delta V_{IO}/\Delta T$	Input Offset Voltage Drift	$R_S = 0\Omega$ <sup>(8)</sup>	-	7	30	$\mu\text{V}/^\circ\text{C}$
$I_{IO}$	Input Offset Current	$V_{CM} = 0\text{ V}$	-	-	75	nA
$\Delta I_{IO}/\Delta T$	Input Offset Current Drift	$R_S = 0\Omega$ <sup>(8)</sup>	-	10	300	$\text{pA}/^\circ\text{C}$
$I_{BIAS}$	Input Bias Current	$V_{CM} = 0\text{ V}$	-	40	200	nA
$V_{I(R)}$	Input Common-Mode Voltage Range	<sup>(7)</sup>	0	-	$V_{CC} - 2.0$	V
$G_V$	Large Signal Voltage Gain	$V_{CC} = 15\text{ V}$ , $R_L = 2.0\text{ k}\Omega$	15	-	-	V/mV
$V_{O(H)}$	Output Voltage Swing	<sup>(7)</sup> $R_L = 2\text{ k}\Omega$	26	-	-	V
$V_{O(L)}$			$R_L = 10\text{ k}\Omega$	27	28	-
$V_{O(L)}$		$V_{CC} = 5\text{ V}$ , $R_L = 10\text{ k}\Omega$	-	5	20	mV
$I_{SOURCE}$	Output Current	$V_{I(+)} = 1\text{ V}$ , $V_{I(-)} = 0\text{ V}$ , $V_{CC} = 15\text{ V}$ , $V_{O(P)} = 2\text{ V}$	10	20	-	mV
$I_{SINK}$		$V_{I(+)} = 0\text{ V}$ , $V_{I(-)} = 1\text{ V}$ , $V_{CC} = 15\text{ V}$ , $V_{O(P)} = 2\text{ V}$	5	8	-	mA
$V_{I(DIFF)}$	Differential Input Voltage	-	-	-	$V_{CC}$	V

**Notes:**

7.  $V_{CC} = 30\text{ V}$  for KA324A.

8. This parameter, although guaranteed is not 100% tested in production.



Typical Performance Characteristics

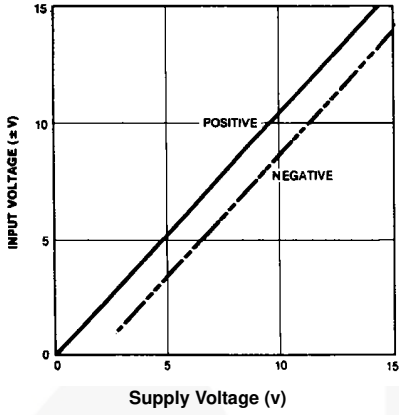

Figure 3. Input Voltage Range vs. Supply Voltage

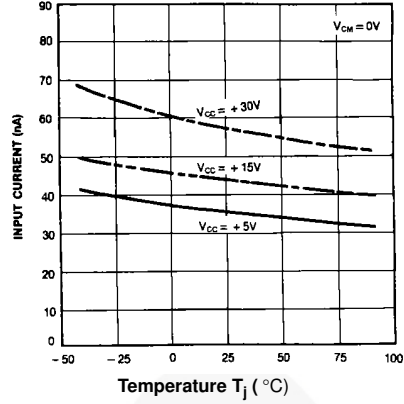

Figure 4. Input Current vs. Temperature

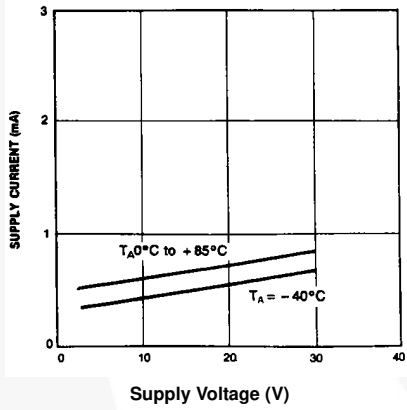

Figure 5. Supply Current vs. Supply Voltage

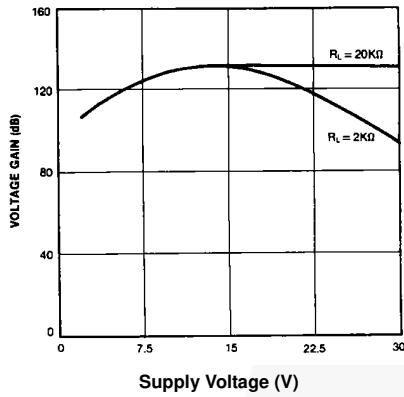

Figure 6. Voltage Gain vs. Supply Voltage

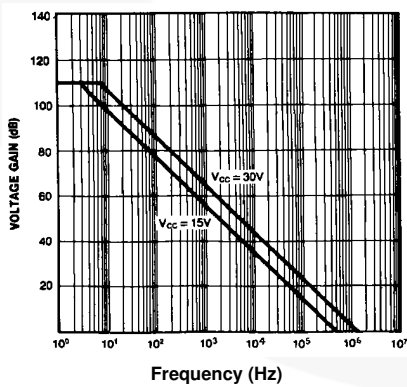

Figure 7. Open Loop Frequency Response

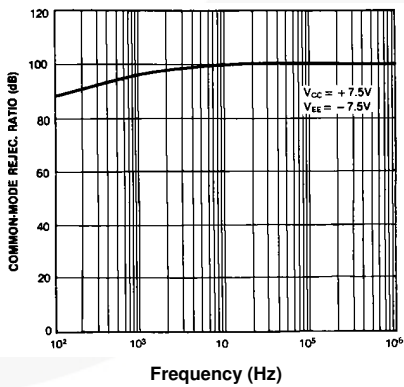

Figure 8. Common Mode Rejection Ratio

Typical Performance Characteristics (Continued)

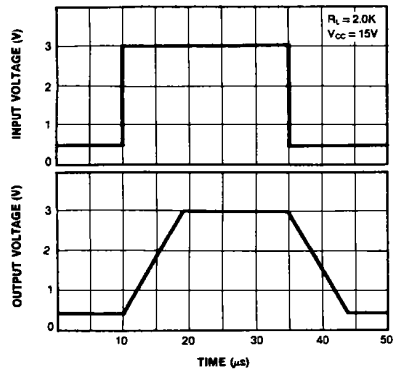

Figure 9. Voltage Follower Pulse Response

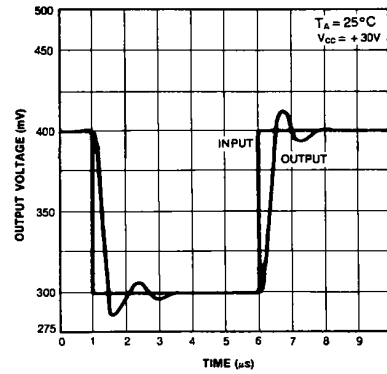

Figure 10. Voltage Follower Pulse Response (Small Signal)

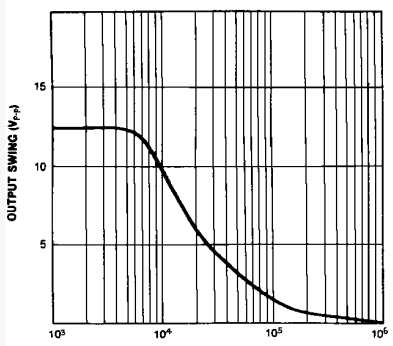

Figure 11. Large Signal Frequency Response

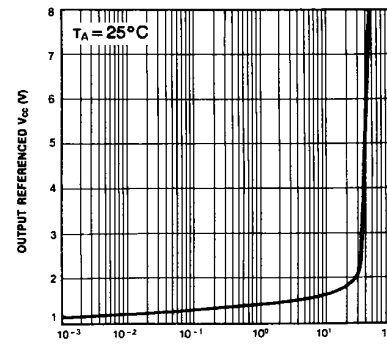

Figure 12. Output Characteristics vs. Current Sourcing

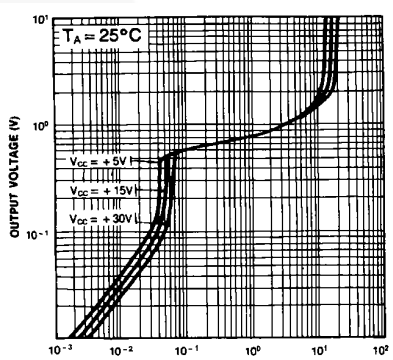

Figure 13. Output Characteristics vs. Current Sinking

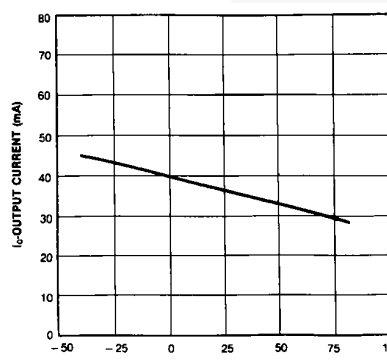
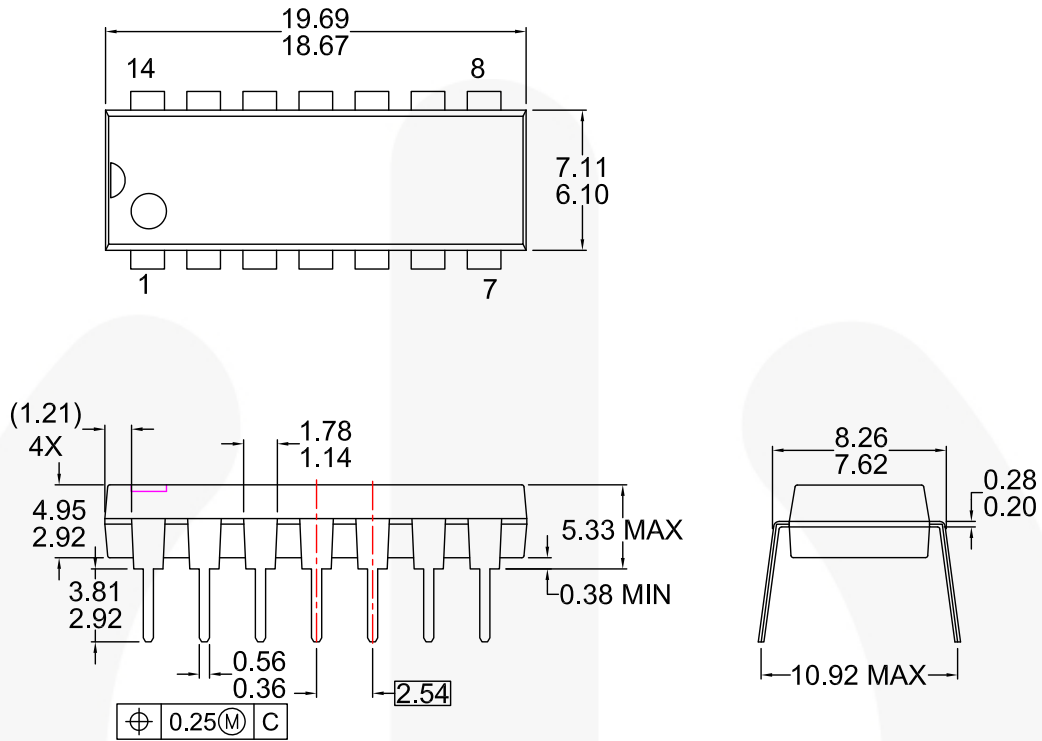

Figure 14. Current Limiting vs. Temperature

**Physical Dimensions**



- NOTES: UNLESS OTHERWISE SPECIFIED  
 THIS PACKAGE CONFORMS TO  
 A) JEDEC MS-001 VARIATION AA  
 B) ALL DIMENSIONS ARE IN MILLIMETERS.  
 DIMENSIONS ARE EXCLUSIVE OF BURRS,  
 C) MOLD FLASH, AND TIE BAR EXTRUSIONS.  
 D) DIMENSIONS AND TOLERANCES PER  
 ASME Y14.5-1994  
 E) DRAWING FILE NAME: MKT-N14AREV8

**Figure 15. 14-LEAD, MDIP, JEDEC MS-001, .300 INCH WIDE**



Physical Dimensions

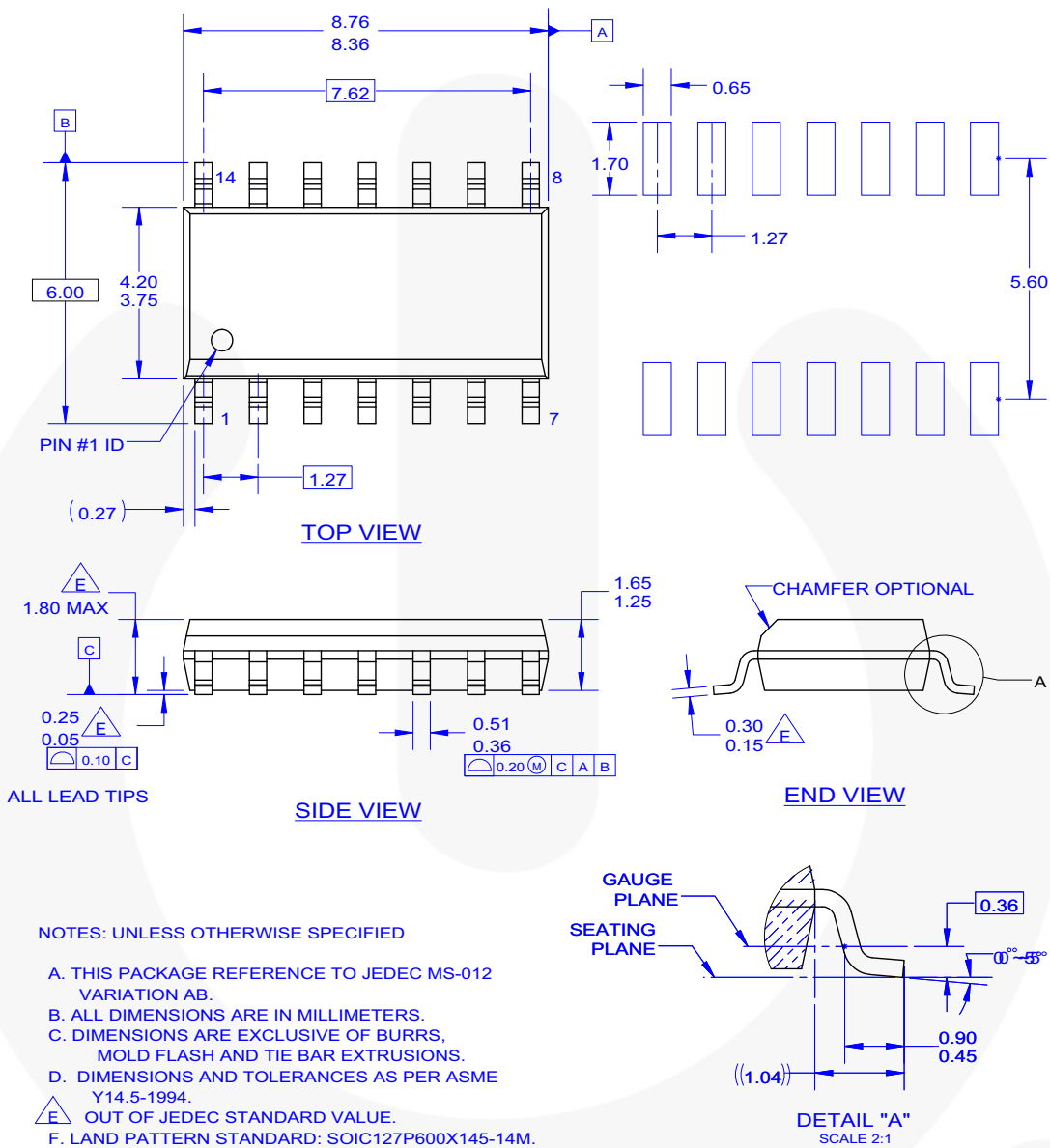







Figure 16. 14-Lead, SOIC, NON-JEDEC, .150 INCH NARROW BODY, 225SOP



### TRADEMARKS

The following includes registered and unregistered trademarks and service marks, owned by Fairchild Semiconductor and/or its global subsidiaries, and is not intended to be an exhaustive list of all such trademarks.

AccuPower™	F-PFS™	OPTOPLANAR®	 SYSTEM GENERAL®
Awinda®	FRFET®	 ®	TinyBoost®
AX-CAP®*	Global Power Resource™	PowerTrench®	TinyBuck®
BitSiC™	GreenBridge™	PowerXS™	TinyCalc™
Build it Now™	Green FPS™	Programmable Active Droop™	TinyLogic®
CorePLUS™	Green FPS™ e-Series™	QFET®	TINYOPTO™
CorePOWER™	Gmax™	QS™	TinyPower™
CROSSVOLT™	GTO™	Quiet Series™	TinyPWM™
CTL™	IntelliMAX™	RapidConfigure™	TinyWire™
Current Transfer Logic™	ISOPLANAR™	 ™	TranSiC™
DEUXPEED®	Making Small Speakers Sound Louder and Better™	Saving our world, 1mW/W/kW at a time™	TriFault Detect™
Dual Cool™	MegaBuck™	SignalWise™	TRUECURRENT®*
EcoSPARK®	MICROCOUPLER™	SmartMax™	μSerDes™
EfficientMax™	MicroFET™	SMART START™	 SerDes™
ESBC™	MicroPak™	Solutions for Your Success™	UHC®
 Fairchild®	MicroPak2™	SPM®	Ultra FRFET™
Fairchild Semiconductor®	MillerDrive™	STEALTH™	UniFET™
FACT Quiet Series™	MotionMax™	SuperFET®	VCX™
FACT®	MotionGrid®	SuperSOT™-3	VisualMax™
FAST®	MTi®	SuperSOT™-6	VoltagePlus™
FastvCore™	MTx®	SuperSOT™-8	XS™
FETBench™	MVN®	SupreMOS®	Xsens™
FPS™	mWSaver®	SyncFET™	仙童™
	OptoHiT™	Sync-Lock™	
	OPTOLOGIC®		

\* Trademarks of System General Corporation, used under license by Fairchild Semiconductor.

### DISCLAIMER

FAIRCHILD SEMICONDUCTOR RESERVES THE RIGHT TO MAKE CHANGES WITHOUT FURTHER NOTICE TO ANY PRODUCTS HEREIN TO IMPROVE RELIABILITY, FUNCTION, OR DESIGN. TO OBTAIN THE LATEST, MOST UP-TO-DATE DATASHEET AND PRODUCT INFORMATION, VISIT OUR WEBSITE AT [HTTP://WWW.FAIRCHILDSEMI.COM](http://www.fairchildsemi.com). FAIRCHILD DOES NOT ASSUME ANY LIABILITY ARISING OUT OF THE APPLICATION OR USE OF ANY PRODUCT OR CIRCUIT DESCRIBED HEREIN; NEITHER DOES IT CONVEY ANY LICENSE UNDER ITS PATENT RIGHTS, NOR THE RIGHTS OF OTHERS. THESE SPECIFICATIONS DO NOT EXPAND THE TERMS OF FAIRCHILD'S WORLDWIDE TERMS AND CONDITIONS, SPECIFICALLY THE WARRANTY THEREIN, WHICH COVERS THESE PRODUCTS.

### LIFE SUPPORT POLICY

FAIRCHILD'S PRODUCTS ARE NOT AUTHORIZED FOR USE AS CRITICAL COMPONENTS IN LIFE SUPPORT DEVICES OR SYSTEMS WITHOUT THE EXPRESS WRITTEN APPROVAL OF FAIRCHILD SEMICONDUCTOR CORPORATION.

As used herein:

1. Life support devices or systems are devices or systems which, (a) are intended for surgical implant into the body or (b) support or sustain life, and (c) whose failure to perform when properly used in accordance with instructions for use provided in the labeling, can be reasonably expected to result in a significant injury of the user.
2. A critical component in any component of a life support, device, or system whose failure to perform can be reasonably expected to cause the failure of the life support device or system, or to affect its safety or effectiveness.

### ANTI-COUNTERFEITING POLICY

Fairchild Semiconductor Corporation's Anti-Counterfeiting Policy. Fairchild's Anti-Counterfeiting Policy is also stated on our external website, [www.fairchildsemi.com](http://www.fairchildsemi.com), under Sales Support.

Counterfeiting of semiconductor parts is a growing problem in the industry. All manufacturers of semiconductor products are experiencing counterfeiting of their parts. Customers who inadvertently purchase counterfeit parts experience many problems such as loss of brand reputation, substandard performance, failed applications, and increased cost of production and manufacturing delays. Fairchild is taking strong measures to protect ourselves and our customers from the proliferation of counterfeit parts. Fairchild strongly encourages customers to purchase Fairchild parts either directly from Fairchild or from Authorized Fairchild Distributors who are listed by country on our web page cited above. Products customers buy either from Fairchild directly or from Authorized Fairchild Distributors are genuine parts, have full traceability, meet Fairchild's quality standards for handling and storage and provide access to Fairchild's full range of up-to-date technical and product information. Fairchild and our Authorized Distributors will stand behind all warranties and will appropriately address any warranty issues that may arise. Fairchild will not provide any warranty coverage or other assistance for parts bought from Unauthorized Sources. Fairchild is committed to combat this global problem and encourage our customers to do their part in stopping this practice by buying direct or from authorized distributors.

### PRODUCT STATUS DEFINITIONS

#### Definition of Terms

Datasheet Identification	Product Status	Definition
Advance Information	Formative / In Design	Datasheet contains the design specifications for product development. Specifications may change in any manner without notice.
Preliminary	First Production	Datasheet contains preliminary data; supplementary data will be published at a later date. Fairchild Semiconductor reserves the right to make changes at any time without notice to improve design.
No Identification Needed	Full Production	Datasheet contains final specifications. Fairchild Semiconductor reserves the right to make changes at any time without notice to improve the design.
Obsolete	Not In Production	Datasheet contains specifications on a product that is discontinued by Fairchild Semiconductor. The datasheet is for reference information only.

Rev. I72

ON Semiconductor and  are trademarks of Semiconductor Components Industries, LLC dba ON Semiconductor or its subsidiaries in the United States and/or other countries. ON Semiconductor owns the rights to a number of patents, trademarks, copyrights, trade secrets, and other intellectual property. A listing of ON Semiconductor's product/patent coverage may be accessed at [www.onsemi.com/site/pdf/Patent-Marking.pdf](http://www.onsemi.com/site/pdf/Patent-Marking.pdf). ON Semiconductor reserves the right to make changes without further notice to any products herein. ON Semiconductor makes no warranty, representation or guarantee regarding the suitability of its products for any particular purpose, nor does ON Semiconductor assume any liability arising out of the application or use of any product or circuit, and specifically disclaims any and all liability, including without limitation special, consequential or incidental damages. Buyer is responsible for its products and applications using ON Semiconductor products, including compliance with all laws, regulations and safety requirements or standards, regardless of any support or applications information provided by ON Semiconductor. "Typical" parameters which may be provided in ON Semiconductor data sheets and/or specifications can and do vary in different applications and actual performance may vary over time. All operating parameters, including "Typicals" must be validated for each customer application by customer's technical experts. ON Semiconductor does not convey any license under its patent rights nor the rights of others. ON Semiconductor products are not designed, intended, or authorized for use as a critical component in life support systems or any FDA Class 3 medical devices or medical devices with a same or similar classification in a foreign jurisdiction or any devices intended for implantation in the human body. Should Buyer purchase or use ON Semiconductor products for any such unintended or unauthorized application, Buyer shall indemnify and hold ON Semiconductor and its officers, employees, subsidiaries, affiliates, and distributors harmless against all claims, costs, damages, and expenses, and reasonable attorney fees arising out of, directly or indirectly, any claim of personal injury or death associated with such unintended or unauthorized use, even if such claim alleges that ON Semiconductor was negligent regarding the design or manufacture of the part. ON Semiconductor is an Equal Opportunity/Affirmative Action Employer. This literature is subject to all applicable copyright laws and is not for resale in any manner.

## PUBLICATION ORDERING INFORMATION

### LITERATURE FULFILLMENT:

Literature Distribution Center for ON Semiconductor  
19521 E. 32nd Pkwy, Aurora, Colorado 80011 USA  
**Phone:** 303-675-2175 or 800-344-3860 Toll Free USA/Canada  
**Fax:** 303-675-2176 or 800-344-3867 Toll Free USA/Canada  
**Email:** [orderlit@onsemi.com](mailto:orderlit@onsemi.com)

**N. American Technical Support:** 800-282-9855 Toll Free  
USA/Canada  
**Europe, Middle East and Africa Technical Support:**  
Phone: 421 33 790 2910  
**Japan Customer Focus Center**  
Phone: 81-3-5817-1050

**ON Semiconductor Website:** [www.onsemi.com](http://www.onsemi.com)  
**Order Literature:** <http://www.onsemi.com/orderlit>  
For additional information, please contact your local  
Sales Representative