



ISM14585-L35 BLE 5.0 SiP
B24P-W w.fl External Antenna

Preliminary Data Sheet



Table of Contents

1	PART NUMBER DETAIL DESCRIPTION	3
1.1	Ordering Information	3
2	OVERVIEW	3
3	FEATURES	3
3.1	Feature Highlights:.....	3
3.2	Application Examples	3
4	DESCRIPTION.....	4
5	ISM14585-L35 SoC & SiP BLOCK DIAGRAMS	4
5.1	DIALOG DA14585 Radio w/Audio I/F SoC	4
5.2	INVENTEK ISM14585-L35 SiP Module & B24P-W w.fl Antenna	5
6	Electrical Specification	7
6.1	Return Loss & Smith Chart.....	7
7	Antenna Dimensions (unit: mm).....	8
8	Radiation Pattern.....	8
8.1	3D Gain Pattern (Radiation Pattern at 2442 MHz).....	8
8.2	Efficiency Table.....	9
8.3	Efficiency vs. Frequency	10
9	PCB Antenna Installation Guide.....	10
9.1	Location	10
9.2	Placement.....	11
9.3	Case Study – PCBA Positioned Underneath	12
10	REVISION CONTROL	13
11	CONTACT INFORMATION.....	13

1 PART NUMBER DETAIL DESCRIPTION

1.1 Ordering Information

Device	Description	Standard Ordering Number
B24P-W w.fl External Antenna	100mm w.fl External Antenna for the Inventek ISM14585 BLE Module	B24P-W

2 OVERVIEW

The Inventek **B24P-W** w.fl External Antenna enables customers to use the Inventek ISM14585 BLE 5.0 Module with an external antenna configuration. The B24P-W w.fl antenna is a polymer substrate antenna. The **B24P-W** w.fl External Antenna supports 2400MHz – 2500MHz frequencies.

3 FEATURES

- **B24P-W** w.fl Dimensions: 30 x 5.0 x 0.5 (mm)
- **B24P-W** w.fl Length: 102 mm (from middle of PCB to the connector, includes connector's length)
- **B24P-W** w.fl coaxial cable: 0.81 mm OD

3.1 Feature Highlights:

- Frequency Band: 2400MHz – 2500MHz frequencies
- Stable and reliable in performances
- Compact size
- RoHS compliance

3.2 Application Examples

- Industrial, Consumer, Medical, etc.
- Voice-controlled remote controls
- Beacons
- (Multi-sensor) Wearable devices

- Fitness trackers
- Consumer health
- Smartwatches
- Human interface devices
 - Keyboard
 - Mouse

4 DESCRIPTION

- The Inventek **B24P-W** w.fl External Antenna is specially designed for 2.4GHz applications. Based on Inventek's proprietary design and processes, this PCB antenna has excellent stability and sensitivity to consistently provide high signal reception efficiency.
- The Inventek **B24P-W** w.fl External Antenna is utilized for the Inventek **ISM14585-L35** BLE 5.0 Module and the Inventek **ISM14585-L35-EVB** Evaluation Board. Please reference the Inventek **ISM14585-L35** BLE 5.0 Module Data Sheet and the Inventek **ISM14585-L35-EVB** Evaluation Board User's Manual for additional information.
- Required Antenna Placement for the Inventek **B24P-W** w.fl External Antenna is tuned on a **1.6mm thick FR-PC material plastic**.

5 ISM14585-L35 SoC & SiP BLOCK DIAGRAMS

5.1 DIALOG DA14585 Radio w/Audio I/F SoC

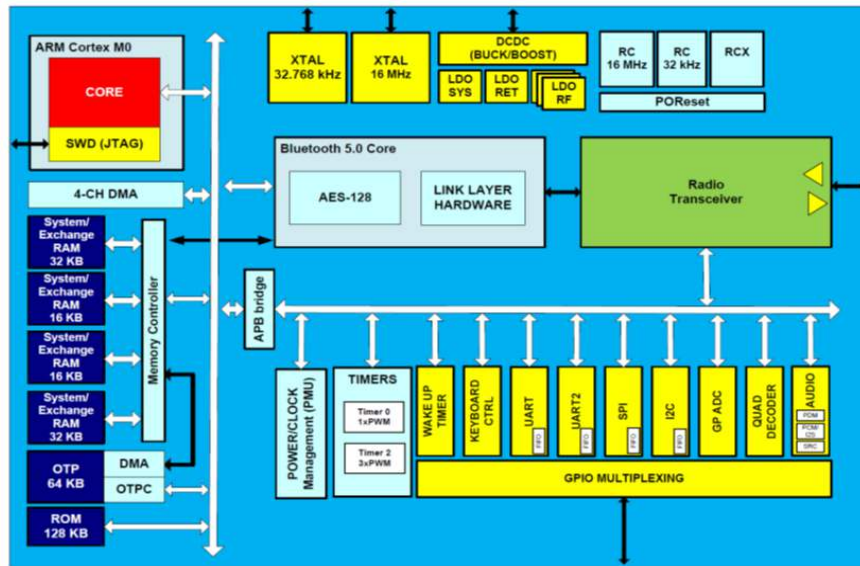

Figure 1 Dialog DA14585 SoC Block Diagram

5.2 INVENTEK ISM14585-L35 SiP Module & B24P-W w.fl Antenna

External Antenna Configuration

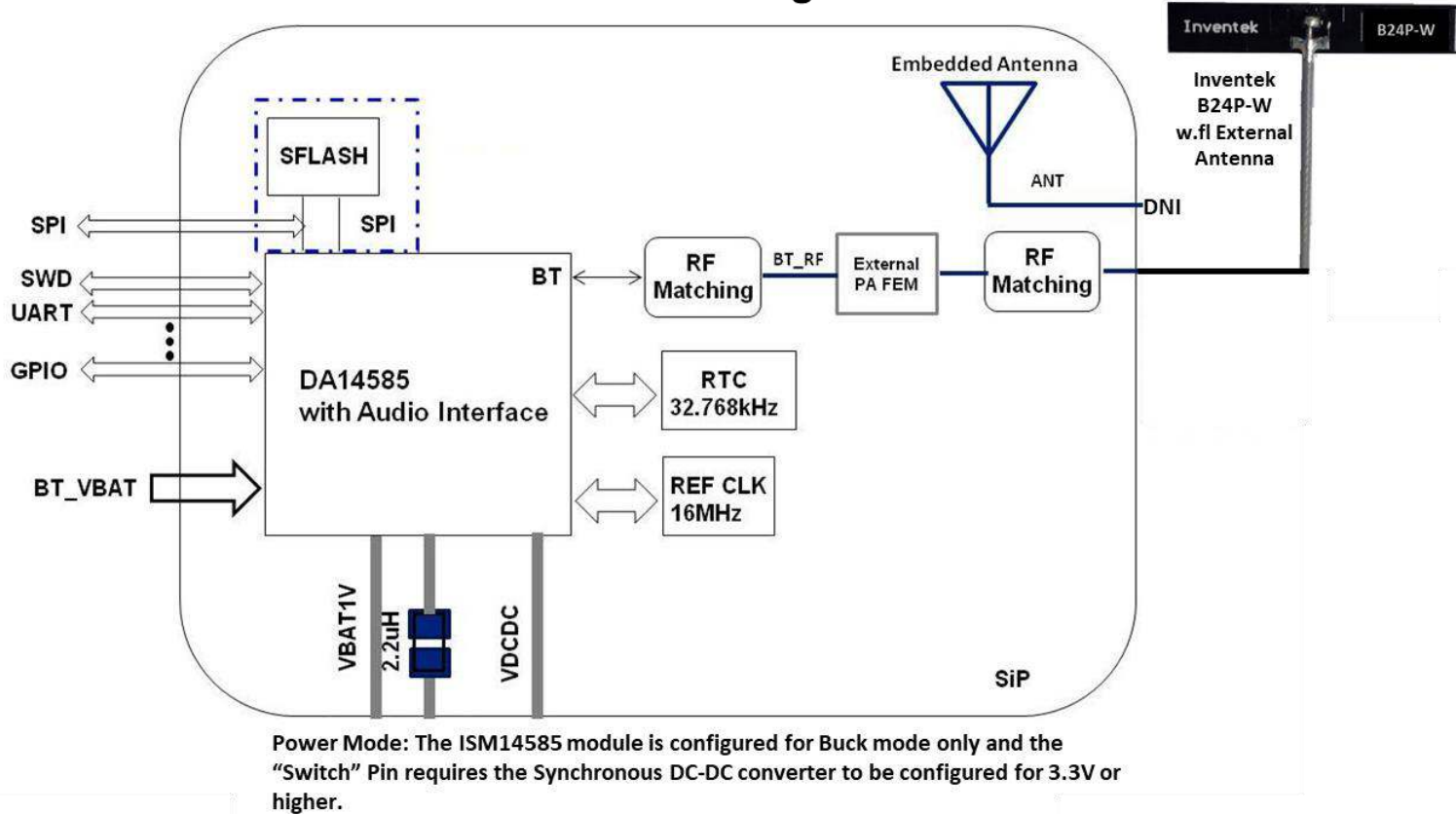

Figure 2 Inventek ISM14585-L35 SiP Block Diagram

- UART Universal synchronous/asynchronous receiver transmitters
- SPI Serial Peripheral Interface
- I2C Inter-Integrated Circuit
- GPIO General-purpose input/output
- SWD Serial Wire Debug

6 Electrical Specification

Characteristics		Specifications	Unit
Outline Dimensions		30 x 5.0 x 0.5	mm
Center Frequency		2442	MHz
Bandwidth		100 Min	MHz
VSWR		2max	
Impedance		50	Ω
Polarization		Linear Polarization	
Gain	Peak Gain	3.2 (typical)	dBi
	Efficiency	79 (typical)	%

6.1 Return Loss & Smith Chart

Return Loss (S11)

Smith Chart(S11)

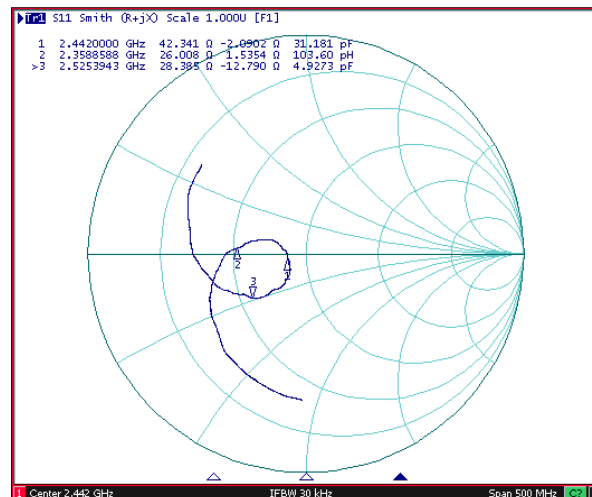
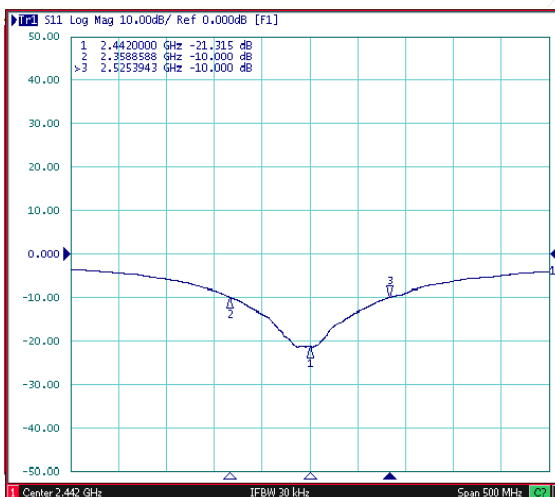

7 Antenna Dimensions (unit: mm)

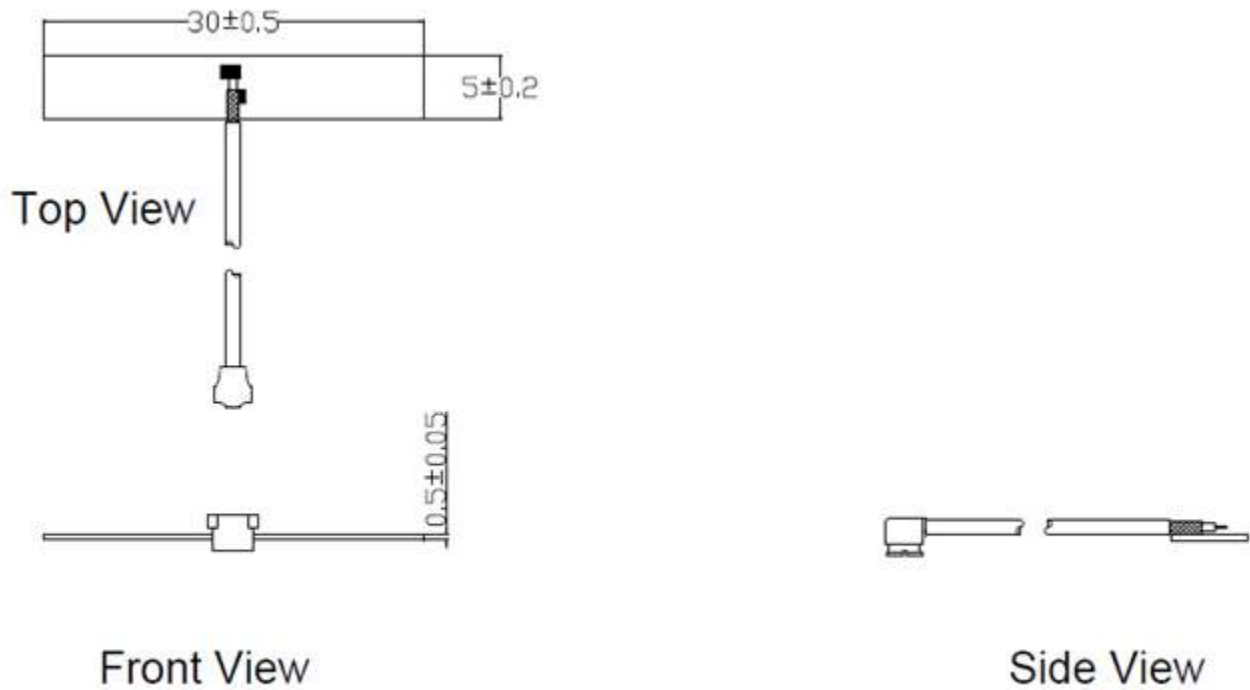

Unit:mm

8 Radiation Pattern

8.1 3D Gain Pattern (Radiation Pattern at 2442 MHz)

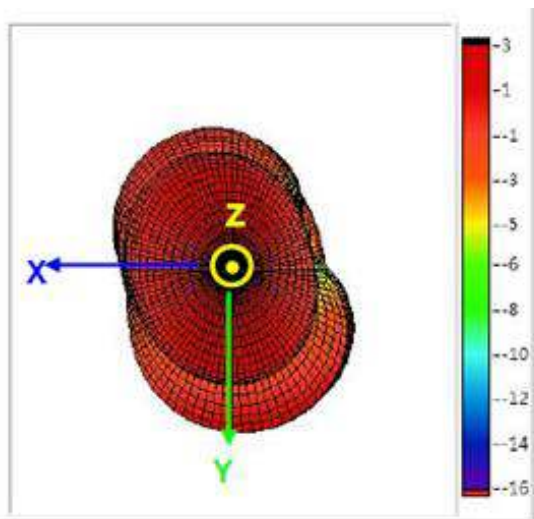

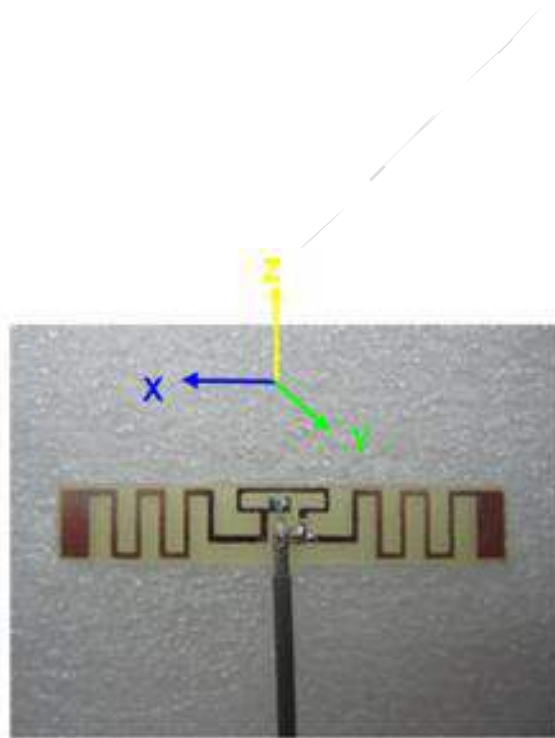
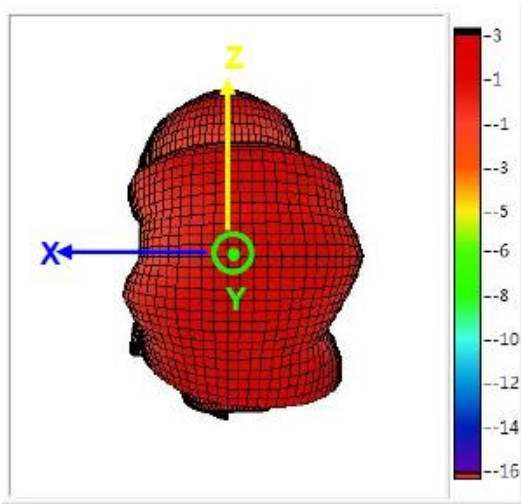
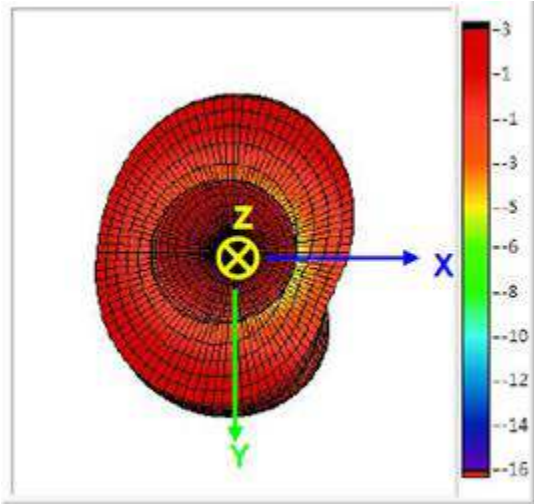

8.2 Efficiency Table

Frequency (MHz)	2.400	2.412	2.417	2.422	2.427	2.432	2.437	2.442	2.447	2.452	2.457	2.462	2.467	2.472	2.484
Efficiency (dB)	-1.51	-1.26	-1.21	-1.13	-1.09	-0.99	-0.90	-1.01	-1.06	-1.04	-0.87	-0.79	-0.82	-0.86	-0.98
Efficiency (%)	70.63	74.82	75.68	77.09	77.80	79.62	81.28	79.25	78.34	78.70	81.85	83.37	82.79	82.04	79.80
Gain (dBi)	2.76	2.96	3.02	3.05	3.15	3.24	3.32	3.26	3.23	3.26	3.42	3.55	3.56	3.58	3.48

8.3 Efficiency vs. Frequency

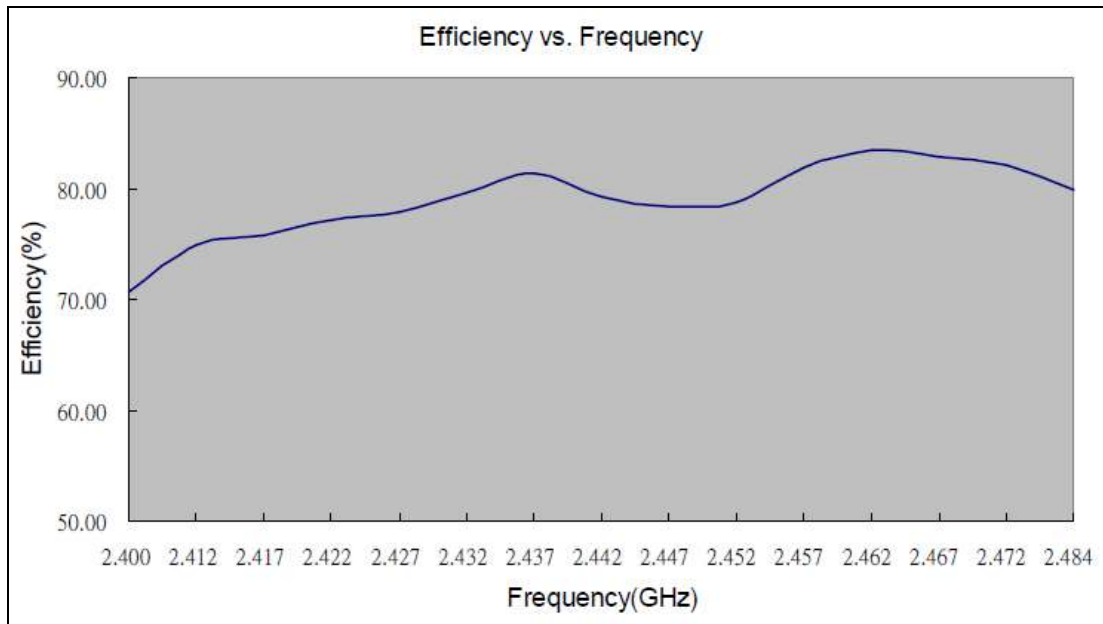

9 PCB Antenna Installation Guide

9.1 Location

- Always stay away from any metallic objects to avoid de-tuning
- Avoid overlapping the PCB directly on any metal substrate and/or LCD monitor
- For example, in location (A), (B), and (C) as illustrated with the Liquid Crystal Module (LCM), display:

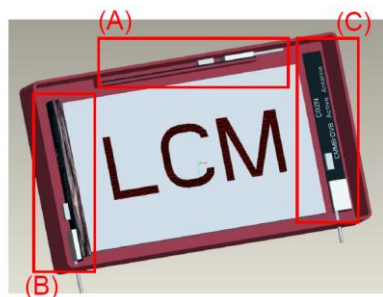

9.2 Placement

- Antennas should be placed >3mm away from any metal and/or LCD/LCM
- For the ease of installation, a >3mm thick tape or foam can be used to separate the antenna from the metal and/or LCD/LCM:

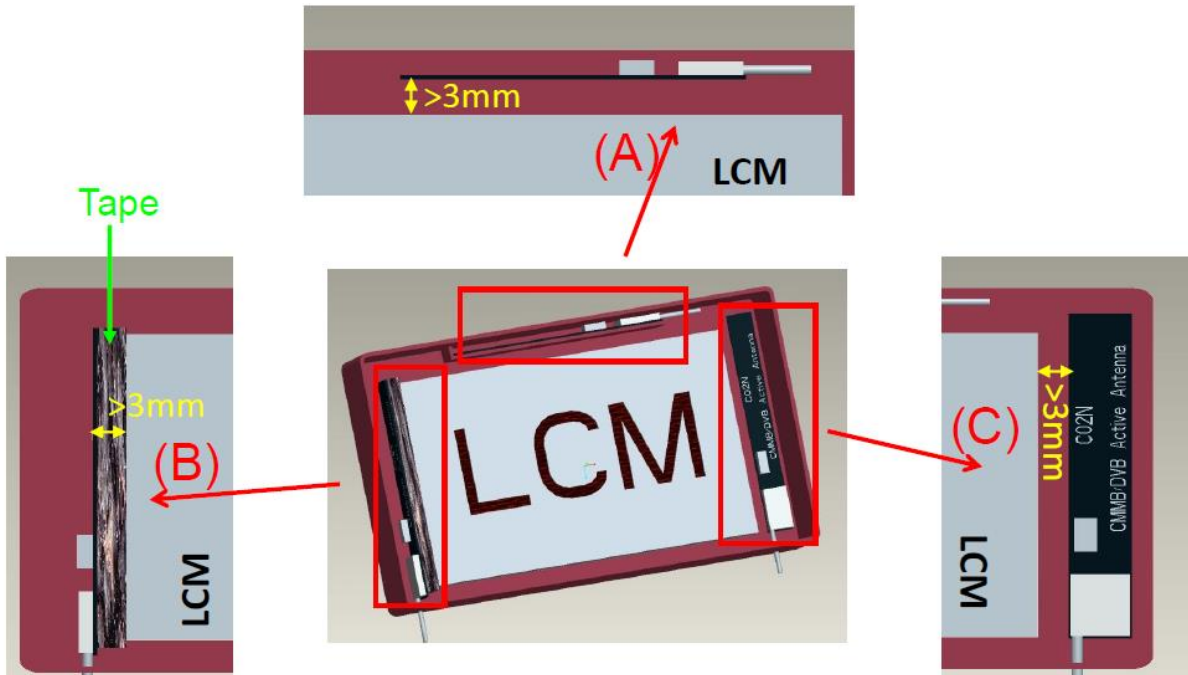

- When there are metal objects on the sides of the PCB antenna, make sure to keep a distance of 3mm from one end and 5mm from another end:

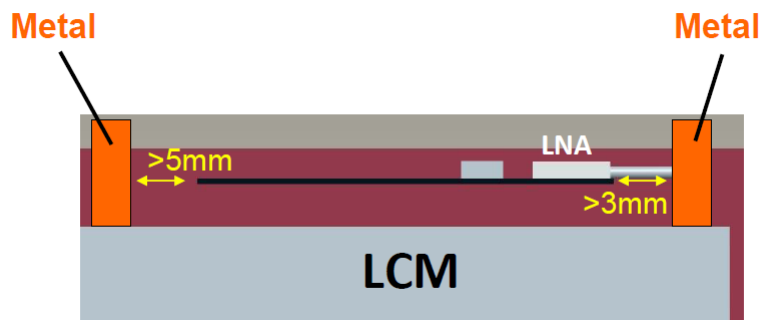

9.3 Case Study – PCBA Positioned Underneath

- For Orientation(A), the PCB antenna should be $>3\text{mm}$ away from the LCM/LCD and PCBA
- For Orientation(B), the PCB antenna should be $>3\text{mm}$ away from the LCM/LCD and PCBA, and adding ground clearance on the PCBA

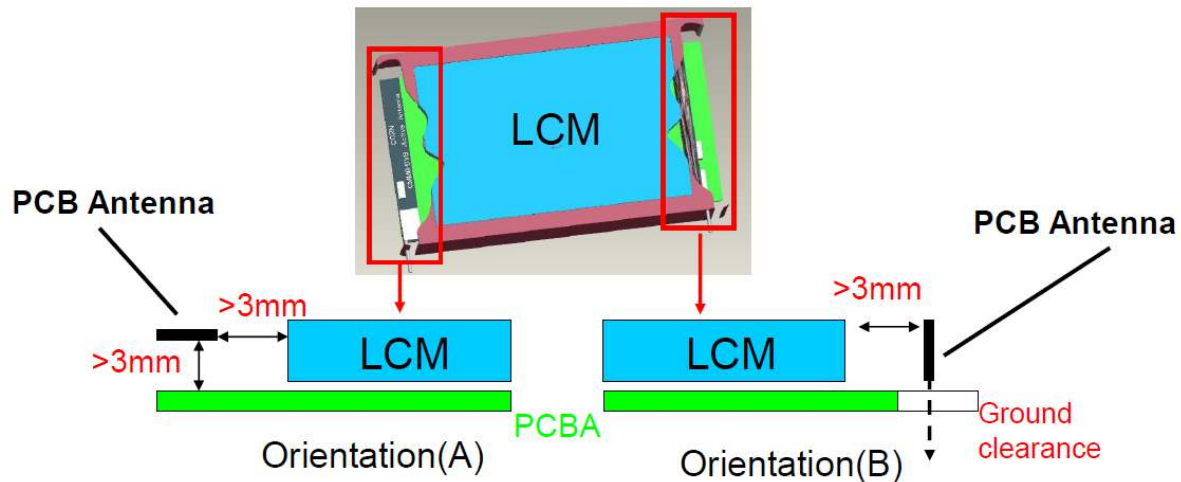

- Another option is to make a rib or fixture to locate the PCB antenna on the side of the unit, to simplify production:

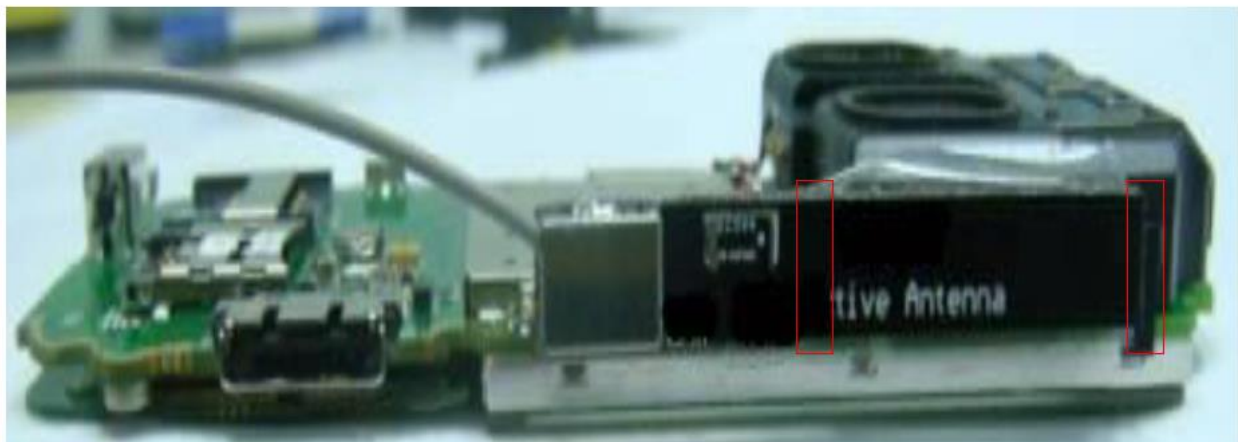

10 REVISION CONTROL

Document: B24P-W	w.fl External Antenna for the ISM14585-L35 BLE 5.0 Module
External Release	DOC-DS-B24P-W-2.5

Date	Author	Revision	Comment
8/10/2018	AS	1.0	Preliminary
3/24/20	AS	2.0	Antenna Placement & Location, Section 9
6/18/20	AS	2.5	Added cable definition of Length in Section 3: 102 mm (from middle of PCB to the connector, includes connector's length)

11 CONTACT INFORMATION

Inventek Systems
2 Republic Road
Billerica Ma, 01862
Tel: 978-667-1962
Sales@inventeksys.com
www.inventeksys.com

Copyright 2017, Inventek Systems. All Rights Reserved. This software, associated documentation and materials ("Software"), referenced and provided with this documentation is owned by Inventek Systems and is protected by and subject to worldwide patent protection (United States and foreign), United States copyright laws and international treaty provisions. Therefore, you may use this Software only as provided in the license agreement accompanying the software package from which you obtained this Software

("EULA"). If no EULA applies, Inventek Systems hereby grants you a personal, non-exclusive, non-transferable license to copy, modify, and compile the Software source code solely for use in connection with Inventek's integrated circuit products.

Any reproduction, modification, translation, compilation, or representation of this Software except as specified above is prohibited without the express written permission of Inventek. Disclaimer: THIS SOFTWARE IS PROVIDED AS-IS, WITH NO WARRANTY OF ANY KIND, EXPRESS OR IMPLIED, INCLUDING, BUT NOT LIMITED TO, NONINFRINGEMENT, IMPLIED WARRANTIES OF MERCHANTABILITY AND FITNESS FOR A PARTICULAR PURPOSE.

Inventek reserves the right to make changes to the Software without notice. Inventek does not assume any liability arising out of the application or use of the Software or any product or circuit described in the Software. Inventek does not authorize its products for use in any products where a malfunction or failure of the Inventek product may reasonably be expected to result in significant property damage, injury, or death ("High Risk Product"). By including Inventek's product in a High Risk product, the manufacturer of such system or application assumes all risk of such use and in doing so agrees to indemnify Inventek against all liability. Inventek Systems reserves the right to make changes without further notice to any products or data herein to improve reliability, function, or design. The information contained within is believed to be accurate and reliable. However, Inventek does not assume any liability arising out of the application or use of this information, nor the application or use of any product or circuit described herein, neither does it convey any license under its patent rights nor the rights of others.

DOC-DS-B24P-W w.fl External Antenna 2.5

