

ITEM NO.	PART NUMBER	DESCRIPTION	QTY.	COMPONENT NOTES
1	TLY-13	NEMA 5-15P	1	white overmold
2	TLY-18L	C13 female, 90°	1	white overmold
3	30-00245	Wire, 3C, 18 AWG, UL SVT, 300V, 105C, 6.3 mm, VW-1, PVC, white	1	
4	Label	Adhesive flag, 15x100mm	1	white with black font

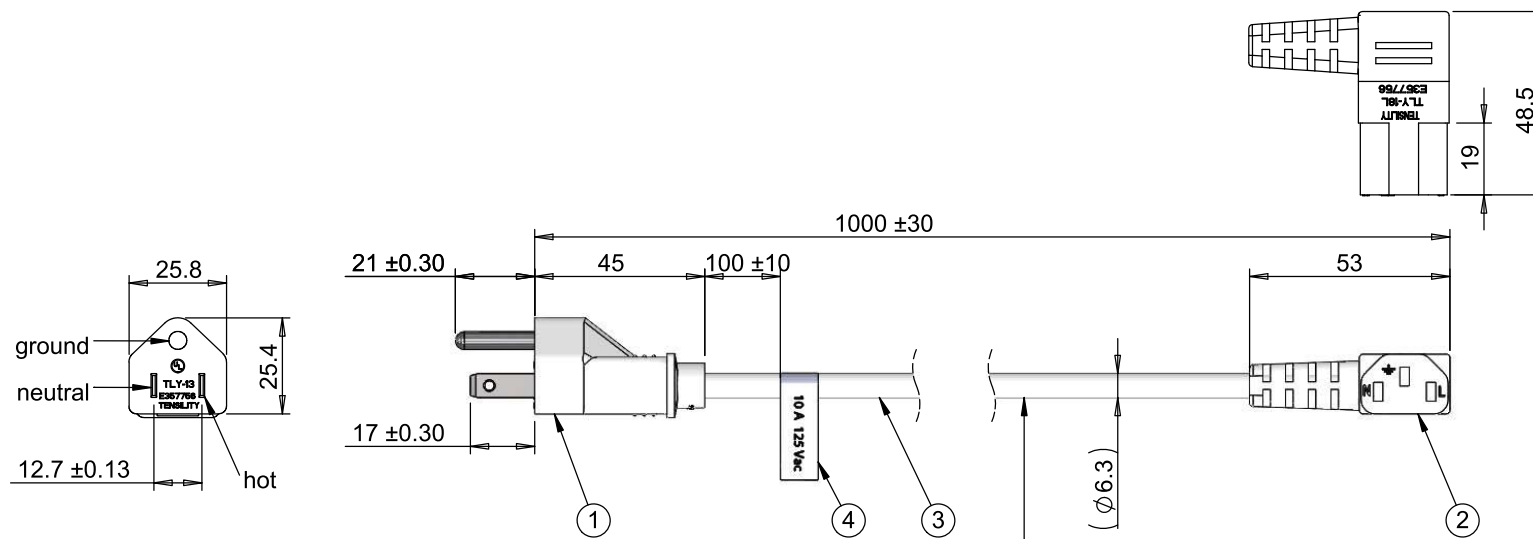

Wire marking: (UL) E339575 SVT 3X0.824mm²
 (18AWG) 105C 300V VW-1 C(UL) SVT 3X0.824mm²
 (18AWG) 105C 300V VW-1 TENSILITY HLE

Wiring Diagram		
TLY-13	wire color	TLY-18L
hot	black	line
neutral	white	neutral
ground	green	ground

Notes:
 Electrical requirements: 10 A at 125 Vac

Revision:	Date:	Description:	Prepared:	Notes:	<h1>TENSILITY</h1> <p>tel 1.541.323.3228 800 877.670.7118 fax 1.541.323.4202 web tensility.com</p>
A	12/20/2012	Initial release	DN <small>Digitally signed by DN Date: 2017.01.26 13:50:34 -08'00'</small>	RoHS compliant	
			Verified: PS <small>Digitally signed by PS Date: 2017.01.26 16:16:41 -08'00'</small>	Function test: no open, no short circuit, no intermittent	
			Dimensions are in millimeters. Tolerances: X: ± 0.5 mm X.X: ± 0.3 mm X.XX: ± 0.05 mm	Description: Ac cord, 1000 mm, U.S, NEMA 5-15P plug, TLY-13 to 90° C13, TLY-18L, 18 AWG, SVT, 30-00245, white	
				Size: A Part number: 11-00036	
				Scale: 1:2	Sheet 1 of 1