

Recommended P.C. Board Layout
SCALE 8:1

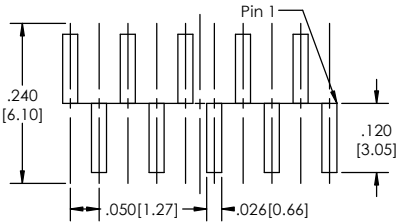

(SVS)

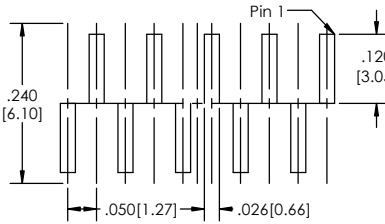

(SMS)

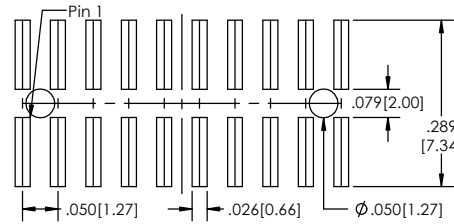

(DV)

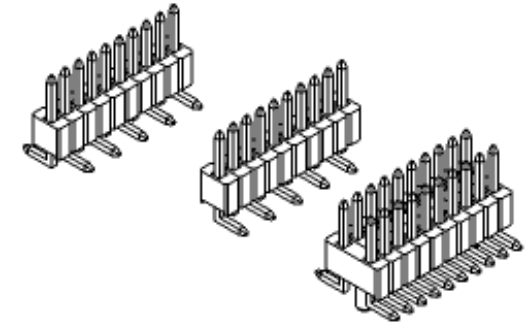

TSHSM-6 [XX] - [X] - [XX] - [XX] - [V] - [XXX] - [X] - [XX] - [X] - [XX] - [LF]
(A) (B) (C) (D) (E) (F) (G) (H) (I) (J) (K)

APPLICATION

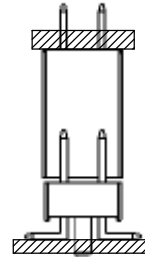

- A. Pins Per Row
 - 1 through 40
- B. Row Specification
 - S= Single Row
 - D= Double Row
- C. Pin Options
 - See Pin Options below
- D. Plating Options
 - See Plating Options below
- E. Vertical
- F. Polarized Position
 - Leave blank if not needed
 - If required, specify empty pin position
 - e.g. 012 for Pin 12
- G. Footprint (Option only available for Single Row)
 - S= pin 1 left
 - M= pin 1 right
- H. Packing Information
 - TR= Tape and Reel
 - TB= Tube
- I. Pad
 - P= Plastic
 - O= No Pad
 - If left blank packaging at MLE's discretion
 - Pad may be metal, mylar or plastic
- J. Alignment Pin Option
 - Leave blank if not needed
 - AP= With
- K. Lead Free

Mates with:
LSSH
SMSS
SSHS

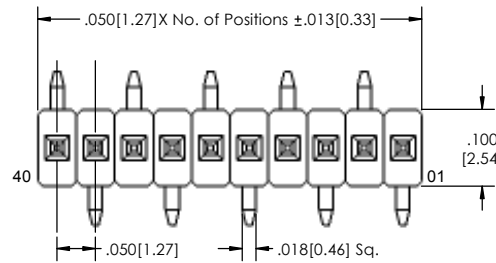

SINGLE (S) ROW

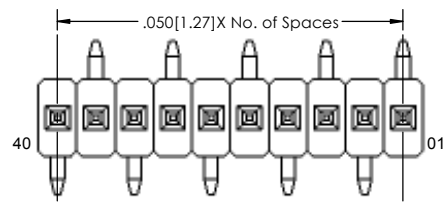

SINGLE (M) ROW

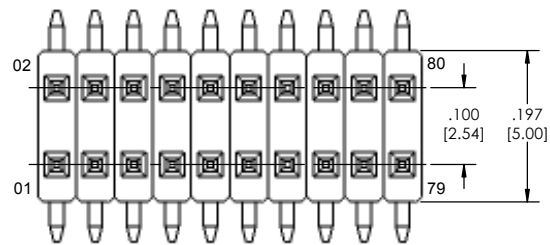

DOUBLE ROW

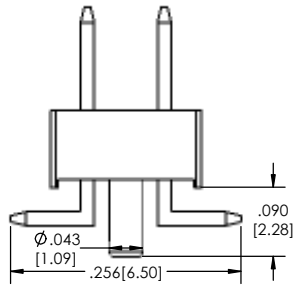
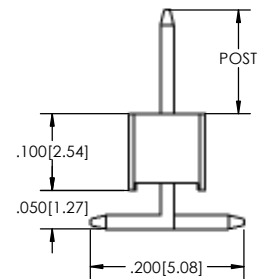

Plating options	
G	-10µ Gold on Contact Area/ Flash on Tail
T	-Matte Tin all Over
GT	-10µ Gold on Contact Area/ Matte Tin on Tail
H	-30µ Gold on Contact Area/ Matte Tin on Tail
F	-Gold Flash over Entire Pin
FT	-Gold Flash on Contact Area/ Matte Tin on Tail

Pin Options		
Post Length		
.100	2.54mm	04
.125	3.18mm	06
.190	4.83mm	08
.205	5.13mm	10
.230	5.84mm	12
.285	7.24mm	14
.335	8.51mm	16
.390	9.91mm	18
.405	10.29mm	20
.430	10.92mm	22
.485	12.32mm	24
.535	13.59mm	26
.605	15.37mm	28
.655	16.64mm	30

Specifications:
Current Rating: 1.0 Ampere
Insulation Resistance: 1000M Ohms Min.
Dielectric Withstanding: 300V AC
Contact Resistance: 20M Ohms Max.
Operation Temperature: -40°C to +105°C
Max. Process Temperature
Peak: 260°C up to 10 secs.
Process: 230°C up to 60 secs.
Wave: 260°C up to 6 secs.
Reflow: 260°C up to 10 secs.
Manual Solder: 350°C up to 5 secs.

Materials:
Contact Material: Phosphor Bronze
Insulator Material: Nylon 6T
Plating: Au or Sn over 50µ" (1.27) Ni

Tails may be clipped to achieve specific dimensions.
Products cut to specific sizes are uncancelable/ nonreturnable.
Parts are subject to change without notice.



PROPRIETARY AND CONFIDENTIAL
THE INFORMATION CONTAINED IN THIS DRAWING IS THE SOLE PROPERTY OF Major League Electronics. ANY REPRODUCTION IN PART OR AS A WHOLE WITHOUT THE WRITTEN PERMISSION OF Major League Electronics IS PROHIBITED.

UNLESS OTHERWISE SPECIFIED:		NAME		DATE	
DIMENSIONS ARE IN INCHES		DRAWN		EOW	
TOLERANCES:		CHECKED		GWE	
ONE DECIMALS ±.100		ENG APPR.			
TWO DECIMAL ±.010		MFG APPR.			
THREE DECIMAL ±.005		ADDRESS:		2533 Centennial Blvd.	
FOUR DECIMAL ±.002		MATERIAL:		Jeffersonville, IN 47130	
NEXT ASSY		FINISH:		Phone: 812-670-4174	
USED ON:		DO NOT SCALE DRAWING		Fax: 812-670-4175	
APPLICATION		E-Mail: mle@mlelectronics.com		TITLE: TSHSM-6-V SERIES	
				SIZE DWG. NO.	
				C	
				REV B	
				SCALE 8:1	
				SHEET 1 OF 1	