

General Description

The DSC613RE1A-0135 is a three-output low power MEMS clock generator.

The MEMS based clock generator eliminates the need of external crystal or reference clock.

Refer to [DSC613 master data sheet](#) to read full descriptions.

Features

- Three LVC MOS clock outputs: 50MHz, 100MHz, 100MHz
- Ultra-small package size: 2.5mm x 2.0mm 6L LGA
- High stability: ± 50 ppm
- Temperature range: -20°C to $+70^{\circ}\text{C}$
- Low power consumption: $\sim 5.2\text{mA}$ (all outputs active)
- Wide supply voltage range: 1.71V -3.63V VDD
- Excellent shock and vibration immunity
- High reliability
- Lead free and RoHS compliant
- AEC-Q100 automotive grade available

Pin Configuration and Description

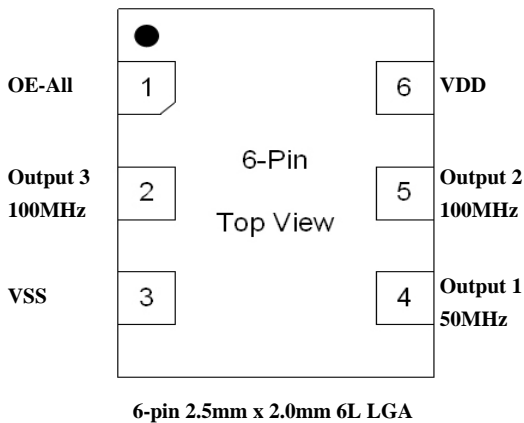

Pin Number	Pin Name	Pin Type	Pin Description
1	OE-All	I	Output Enable H = Output Active L = Output Disabled (High Impedance)
2	Output 3	O	100MHz LVC MOS Clock Output Controlled by Pin 1 (OE-All)
3	VSS	Power	Power Supply Ground
4	Output 1	O	50MHz LVC MOS Clock Output Controlled by Pin 1 (OE-All)
5	Output 2	O	100MHz LVC MOS Clock Output Controlled by Pin 1 (OE-All)
6	VDD	Power	Power Supply

ClockWorks is a registered trademark of Microchip Technology Inc.

Ordering Information

Ordering Part Number	Temperature Range	High Stability	Shipping	Package
DSC613RE1A-0135	-20°C to +70°C	±50ppm	Tube	2.5mm x 2.0mm 6L LGA
DSC613RE1A-0135T	-20°C to +70°C	±50ppm	Tape and Reel	2.5mm x 2.0mm 6L LGA

Devices are Green and RoHS compliant. Sample material may have only a partial top mark.

Microchip makes no representations or warranties with respect to the accuracy or completeness of the information furnished in this data sheet. This information is not intended as a warranty and Microchip does not assume responsibility for its use. Microchip reserves the right to change circuitry, specifications and descriptions at any time without notice. No license, whether express, implied, arising by estoppel or otherwise, to any intellectual property rights is granted by this document. Except as provided in Microchip's terms and conditions of sale for such products, Microchip assumes no liability whatsoever, and Microchip disclaims any express or implied warranty relating to the sale and/or use of Microchip products including liability or warranties relating to fitness for a particular purpose, merchantability, or infringement of any patent, copyright or other intellectual property right.

Microchip products are not designed or authorized for use as components in life support appliances, devices or systems where malfunction of a product can reasonably be expected to result in personal injury. Life support devices or systems are devices or systems that (a) are intended for surgical implant into the body or (b) support or sustain life, and whose failure to perform can be reasonably expected to result in a significant injury to the user. A Purchaser's use or sale of Microchip Products for use in life support appliances, devices or systems is a Purchaser's own risk and Purchaser agrees to fully indemnify Microchip for any damages resulting from such use or sale.

© 2018 Microchip Technology Inc.

6-Lead 2.5 mm x 2.0 mm VFLGA Package Outline and Recommended Land Pattern

6-Lead Very Thin Fine Pitch Land Grid Array (AWA) - 2.5x2.0 mm Body [VFLGA]

Note: For the most current package drawings, please see the Microchip Packaging Specification located at <http://www.microchip.com/packaging>

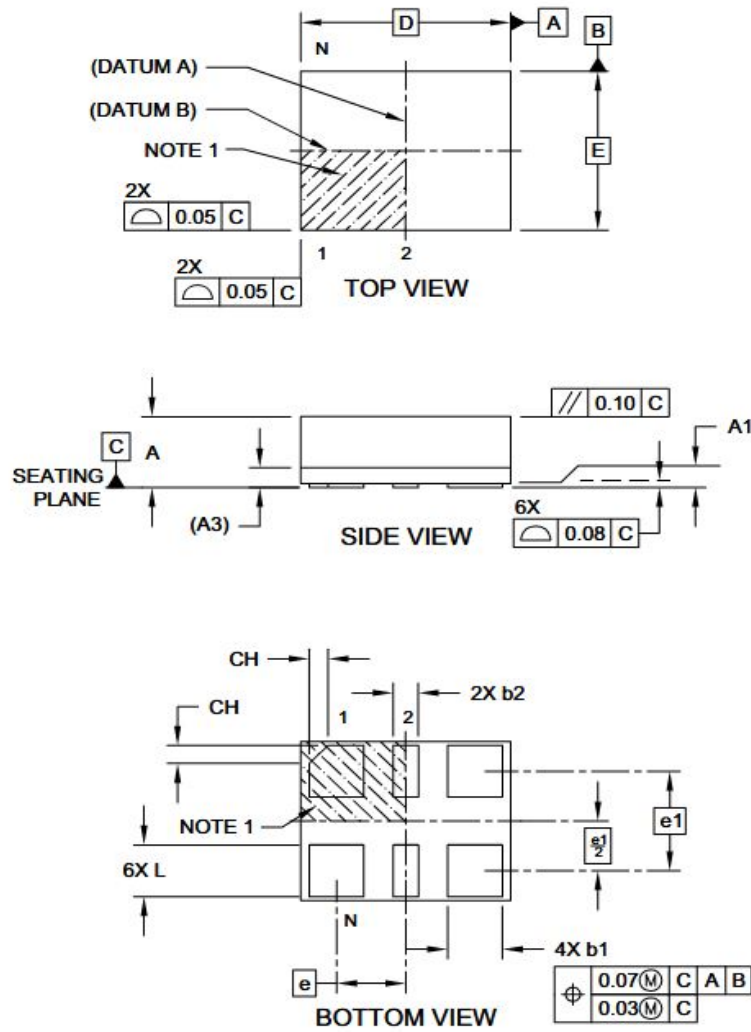

Microchip Technology Drawing C04-1204A Sheet 1 of 2

6-Lead Very Thin Fine Pitch Land Grid Array (AWA) - 2.5x2.0 mm Body [VFLGA]

Note: For the most current package drawings, please see the Microchip Packaging Specification located at <http://www.microchip.com/packaging>

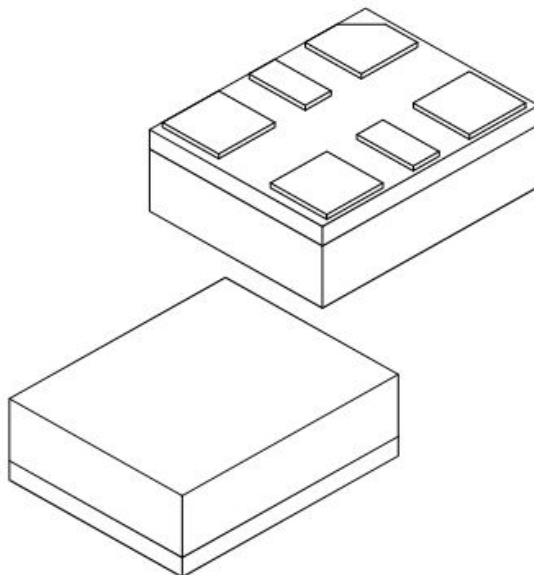

Dimension Limits	Units	MILLIMETERS		
		MIN	NOM	MAX
Number of Terminals	N	6		
Terminal Pitch	e	0.825 BSC		
Terminal Pitch	e1	1.25 BSC		
Overall Height	A	0.79	0.84	0.89
Standoff	A1	0.00	0.02	0.05
Substrate Thickness (with Terminals)	A3	0.20 REF		
Overall Length	D	2.50 BSC		
Overall Width	E	2.00 BSC		
Terminal Width	b1	0.60	0.65	0.70
Terminal Width	b2	0.25	0.30	0.35
Terminal Length	L	0.60	0.65	0.70
Terminal 1 Index Chamfer	CH	-	0.225	-

Notes:

- Pin 1 visual index feature may vary, but must be located within the hatched area.
- Package is saw singulated
- Dimensioning and tolerancing per ASME Y14.5M
BSC: Basic Dimension. Theoretically exact value shown without tolerances.
REF: Reference Dimension, usually without tolerance, for information purposes only.

Microchip Technology Drawing C04-1204A Sheet 2 of 2

6-Lead Very Thin Fine Pitch Land Grid Array (AWA) - 2.5x2.0 mm Body [VFLGA]

Note: For the most current package drawings, please see the Microchip Packaging Specification located at <http://www.microchip.com/packaging>

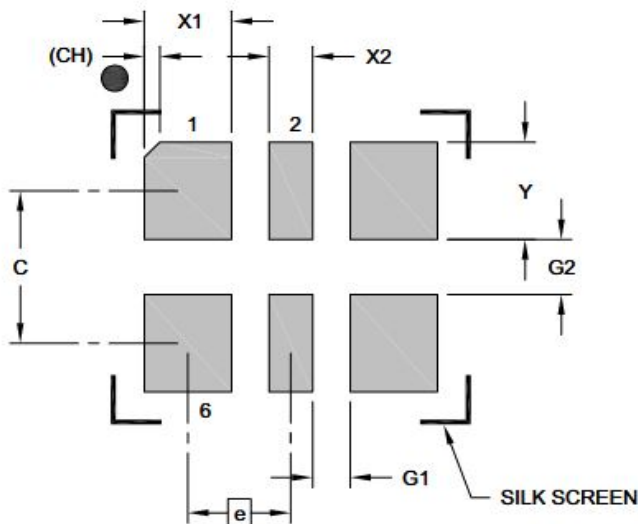

RECOMMENDED LAND PATTERN

Dimension Limits	Units	MILLIMETERS		
		MIN	NOM	MAX
Contact Pitch	E	0.825 BSC		
Contact Spacing	C	1.25 BSC		
Contact Width (X4)	X1			0.70
Contact Width (X2)	X2			0.35
Contact Pad Length (X6)	Y			0.80
Space Between Contacts (X4)	G1	0.30		
Space Between Contacts (X3)	G2	0.45		
Contact 1 Index Chamfer	CH	0.13 X 45° REF		

Notes:

1. Dimensioning and tolerancing per ASME Y14.5M
BSC: Basic Dimension. Theoretically exact value shown without tolerances.

Microchip Technology Drawing C04-3204A