

Press-Fit Card Edge Connectors 0.156" (3.96mm) Pitch

Features:

- 0.156" (3.96mm) contact spacing x 0.200" (5.08mm) row spacing
- Accepts 0.062" (1.57mm) nominal thickness P.C. board
- Low profile insulator body, 0.550" (13.97mm)
- Contact termination options include P.C. tail, and 0.025" (0.64mm) square wire wrap
- Press-fit compliant section for gas tight reliable connection in plated through holes eliminates soldering operations
- Single or dual row configurations
- Accepts between contact and in-contact polarizing keys (special features if requested)
- Tools available for insulator and contact removal. Simple "flat rock" tooling is used for connector installation
- RoHS Compliant & UL Certified



Specifications:

Insulator Material	UL 94V-0 Thermoplastic Polyester, Black
Contact Material	Copper Alloy
Contact Plating	30µ" Gold Plating on mating area and Tin Plating on tails with Nickel underplating all over
Current Rating	3 amps
Contact Resistance	10 milliohms maximum
Dielectric Withstanding Voltage	1200 V AC rms at sea level between adjacent contacts
Insulation Resistance	5000 megaohms minimum
Operating Temperature	-40°C to +105°C
Insertion Force	16 oz (4.45 N) maximum per contact pair when tested with .070" (1.78mm) thick gauge
Withdrawal Force	1 oz (0.28 N) minimum per contact pair when tested with .054" (1.37mm) thick gauge
Contact insertion into Hole	20 lbs (89 N) maximum
Contact Retention in Hole	10 lbs (44 N) minimum
Re-Insertability in same Hole	3 Times minimum

Example Part Number: **717-044-520-201**

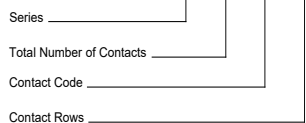

Series: 717
Insulator Color: Thermoplastic Polyester, Green

Total Number of Contacts: 005, 006, 043
Contact Rows: Single Row
010, 012, 086
Dual Row

Contact Code:	Description:	Contact Point:	Tail Length "G":
520	P.C. Tail	Regular Point	.190 (4.83)
522	P.C. Tail	Regular Point	.375 (9.53)
525	P.C. Tail	High Point	.190 (4.83)
540	Wire Wrap	Regular Point	.560 (14.22)
541	Wire Wrap	Regular Point	.750 (19.05)
545	Wire Wrap	High Point	.560 (14.22)
560	Make Before Break (MBB) Contacts		.190 (4.83)

Contact Rows: 101
Description: Single Row
201
Dual Row

**BETWEEN CONTACT
POLARIZING KEY
P/N 306-240-318**

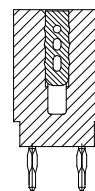

**PROPOSED
IN-CONTACT
POLARIZING KEY
P/N 725-240-328**



Ordering Code Notes:

- 1) All connector sizes up to 43 contacts single row / 86 contacts dual row are available upon request.
- 2) Make-Before-Break switching contacts, assembled in specific contact positions, are available upon request.

Press-Fit Card Edge Connectors 0.156" (3.96mm) Pitch

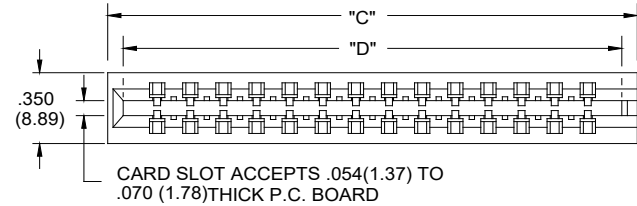

SECTIONS "Y" — "Y" CONTACT ROWS & INSULATOR OPTIONS

Single Row Versions May Require Backup Springs Depending upon the Application.

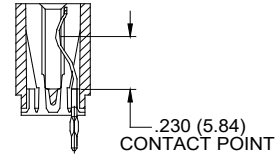

CODE 101
Single Row Versions May Require Backup Springs Depending upon the Application.

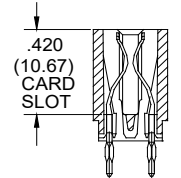

CODE 201

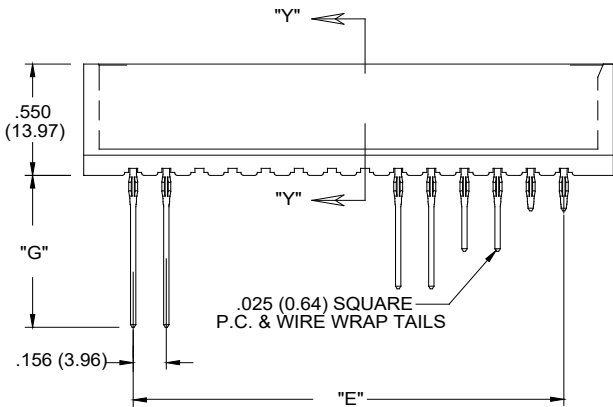

MAKE BEFORE BREAK (M.B.B) POINT CONTACTS

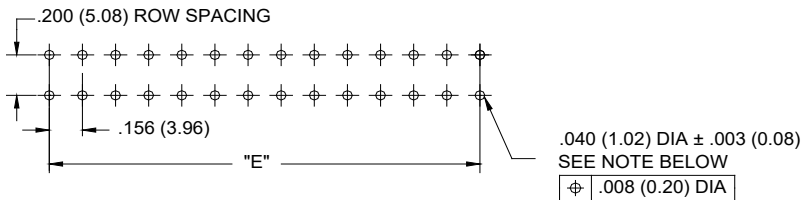

TO OBTAIN OPTIMUM COMPLIANT SECTION PERFORMANCE,
DRILL HOLES .0453 ± .001 (1.15 ± 0.03) DIAMETER
COPPER PLATE, .001 (25.4 MICRONS) MINIMUM THICKNESS,
FOLLOWED BY TIN PLATE TO PROVIDE FINISHED
HOLES .040 ± .003 (1.02 ± 0.08) DIAMETER

