



FocusLCDs.com
LCDs MADE SIMPLE®

Ph. 480-503-4295 | NOPP@FocusLCD.com

TFT | CHARACTER | UWVD | FSC | SEGMENT | CUSTOM | REPLACEMENT

TFT Display Module

Part Number

E35RF-I-RS920-N

Overview:

- 3.5-inch TFT (76.9x63.9 I I)
- 320x240 pixels
- 3SPI + 24 EQ WD. LIT LIT
- Special Temperature Range
- All View
- IPS
- No Touch Panel
- 920 nits
- TFT IC: ST7272A
- RoHS Compliant

Description

This is a color active matrix TFT (Thin Film Transistor) LCD (Liquid Crystal Display) that uses amorphous silicon TFT as a switching device. This model is composed of a transmissive type TFT LCD Panel, driver circuit, capacitive touch panel, and a backlight unit. The resolution of this 3.5" TFT LCD contains 320(RGB)x240 pixels and can display up to 16.7M colors.

TFT Features

Low Input Voltage: 3.3V

Display Colors: 16.7M

TFT Interface: 3SPI+24-bit RGB

General Information Items	Specification	Unit	Note
	Main Panel		
TFT Active area (AA)	70.08(H) x 52.56(V) (3.5 inch)	mm	-
Driver Element	TFT active matrix	-	-
Display Colors	16.7M	colors	-
Number of pixels	320(RGB)x240	dots	-
TFT Pixel arrangement	RGB vertical stripe	-	-
Pixel Pitch	0.219(H) x 0.219 (V)	mm	-
Viewing angle	All	o'clock	-
TFT Controller IC	ST7272A	-	-
TFT Interface	24-bit RGB	-	-
Display mode	Transmissive/ Normally Black	-	-
Operating temperature	-30-+85	°C	-
Storage temperature	-40-+85	°C	-

Mechanical Information

Item		Min	Typ.	Max	Unit	Note
Module Size	Horizontal (H)		76.90		mm	-
	Vertical (V)		63.90		mm	-
	Depth (D)		3.17		mm	-
	Weight		27		g	

1. Outline Dimensions

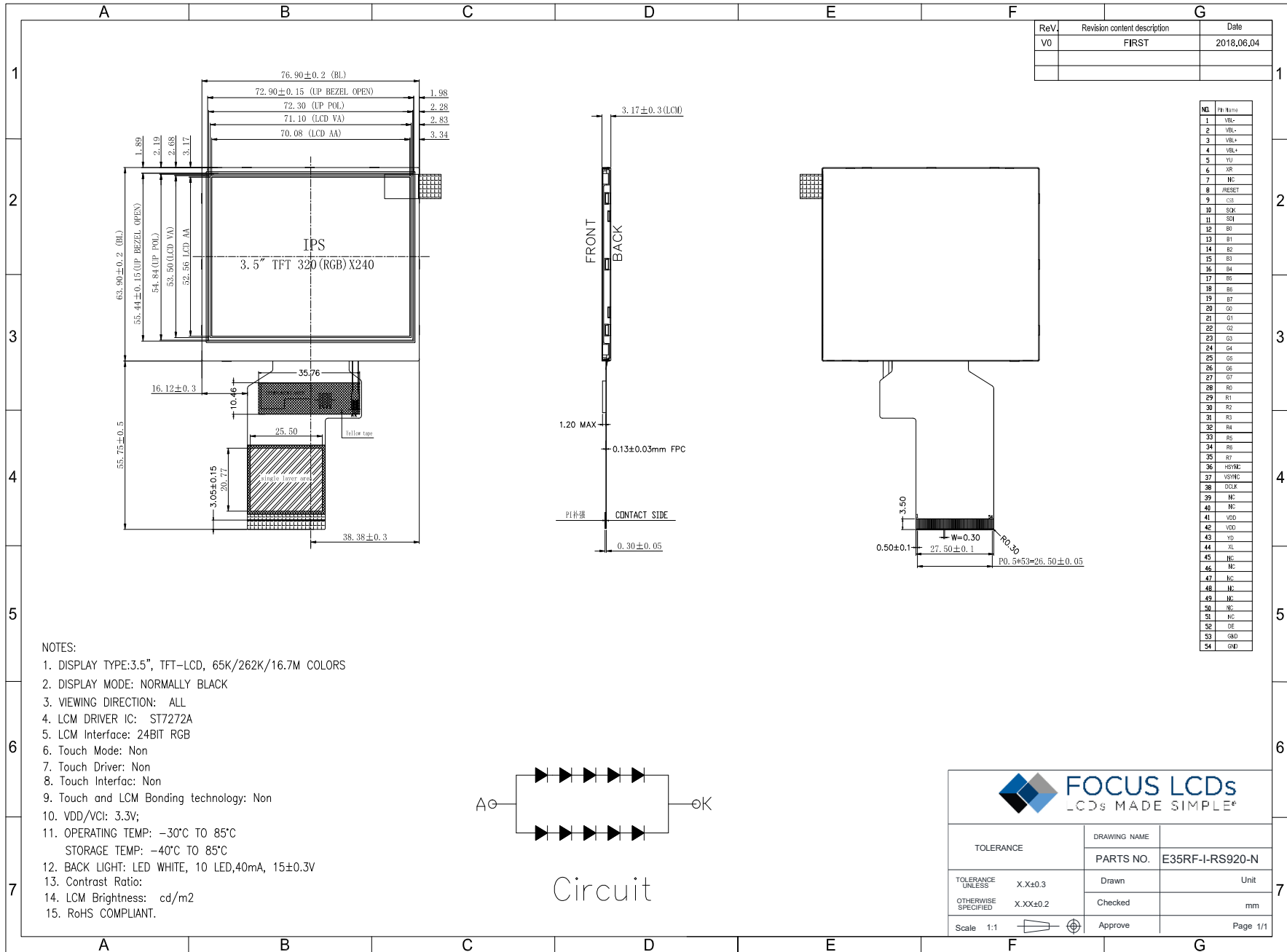

Rev.	Revision content description	Date
V0	FIRST	2018.06.04

NO.	Pin Name
1	VBL+
2	VBL-
3	VBL+
4	VBL+
5	YU
6	XR
7	NO
8	RESET
9	CS
10	SDA
11	SCL
12	SS
13	B1
14	B2
15	B3
16	B4
17	B5
18	B6
19	B7
20	B8
21	B9
22	B10
23	B11
24	B12
25	B13
26	B14
27	B15
28	B16
29	B17
30	B18
31	B19
32	B20
33	B21
34	B22
35	B23
36	HSYNC
37	VSYNC
38	CLK
39	NC
40	NC
41	VDD
42	VDD
43	VO
44	XL
45	NC
46	NC
47	NC
48	NC
49	NC
50	NC
51	NC
52	DE
53	GND
54	GND

FOCUS LCDs
LCDs MADE SIMPLE®

TOLERANCE	DRAWING NAME	PARTS NO.	E35RF-I-RS920-N
TOLERANCE UNLESS OTHERWISE SPECIFIED	X.X±0.3	Drawn	Unit
	X.XX±0.2	Checked	mm
Scale 1:1	⊕	Approve	Page 1/1

2. Block Diagram

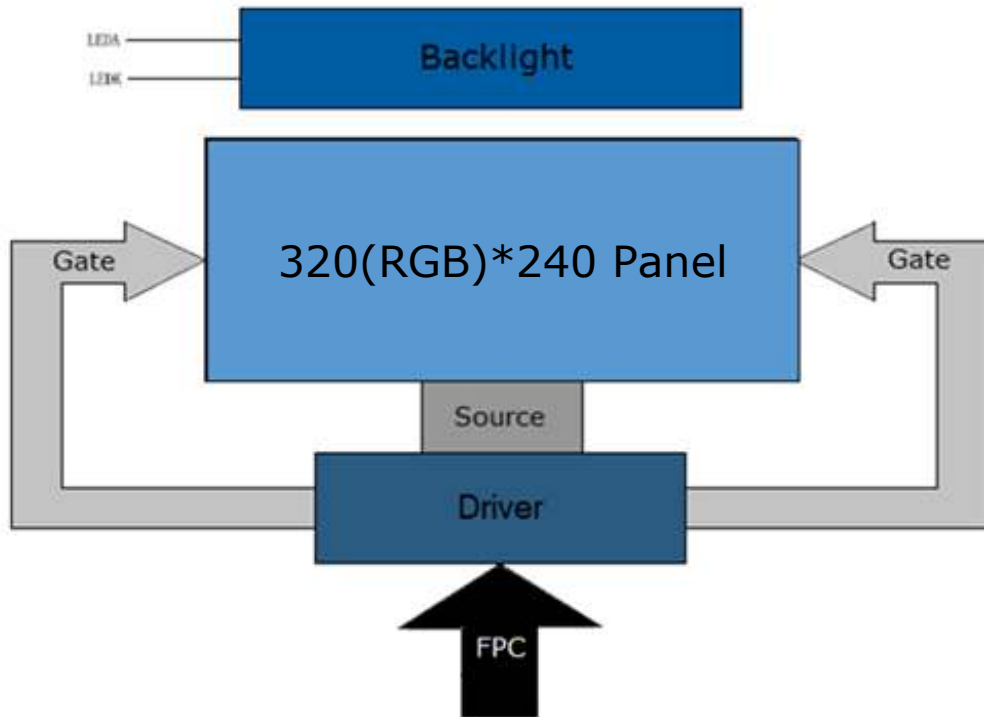

3. Input TFT Terminal Pin Assignment

Recommended Connector: F32Q-1A7H1-11054

NO.	Symbol	Description	I/O
1	LEDK	Cathode pin of the backlight	P
2	LEDK	Cathode pin of the backlight	P
3	LEDA	Anode pin of the backlight	P
4	LEDA	Anode pin of the backlight	P
5	YU(NC)	Touch panel top film terminal. Not connected.	
6	XR(NC)	Touch panel right glass terminal. Not connected.	
7	NC	Not connected	
8	RESET	Reset signal of the device. When low, the internal initialization procedure is executed.	I
9	CSB	Chip select signal for the SPI interface.	I
10	SCK	Clock signal for the SPI interface.	I
11	SDI	Serial data input and output pin for the SPI interface.	I/O
12-19	B0-B7	8-bit blue data bus for the RGB interface. For the 8-bit RGB interface, these pins are not used and can be connected to GND.	I/O
20-27	G0-G7	8-bit green data bus for the RGB interface. These pins are used in the 8-bit RGB interface.	I/O
28-35	R0-R7	8-bit red data bus for the RGB interface. These pins are not used in the 8-bit RGB interface and can be connected to GND.	I/O
36	HSYNC	Horizontal sync signal for the RGB interface. Negative polarity is the default.	I
37	VSYNC	Vertical sync signal for the RGB interface. Negative polarity is the default.	I
38	DCLK	Dot clock signal for the RGB interface.	I
39	NC	Not connected	
40	NC	Not connected	
41	VDD	Supply voltage (3.3V)	P
42	VDD	Supply voltage (3.3V)	P
43	YD(NC)	Touch panel bottom film terminal. Not connected.	
44	XL(NC)	Touch panel left glass terminal. Not connected.	
45	NC	Not connected	
46	NC	Not connected	
47	NC	Not connected	
48	NC	Not connected	
49	NC	Not connected	
50	NC	Not connected	
51	NC	Not connected	
52	DE	Data enable signal for the RGB interface. Data enabled when DE is high.	I
53	GND	Ground	P
54	GND	Ground	P

I: Input, O: Output, P: Power

4. LCD Optical Characteristics

4.1 Optical Specifications

Item	Symbol	Condition	Min	Typ.	Max	Unit	Note	
Color Gamut	S%	θ=0 Normal viewing angle	55	60	--	%	(3)	
Contrast Ratio	CR		640	800	--	%	(2)	
Response Time	Rising		Tr	--	30	40	ms	(4)
	Falling		TF					
Color Filter Chromaticity	White		W _X	0.287	0.327	0.367		(5)(6)
			W _Y	0.330	0.370	0.410		
	Red		R _X	0.580	0.620	0.660		
			R _Y	0.314	0.354	0.394		
	Green		G _X	0.317	0.357	0.397		
			G _Y	0.563	0.603	0.643		
	Blue	B _X	0.110	0.150	0.190			
		B _Y	0.041	0.081	0.121			
Viewing Angle	Hor.	ΘL	70	80	--	degrees	(1)(6)	
		ΘR	70	80	--			
	Ver.	ΘT	70	80	--			
		ΘB	70	80	--			
Option View Direction	All						(1)	

Optical Specification Reference Notes:

(1) Definition of Viewing Angle: The viewing angle is the angle at which the contrast ratio is greater than 10. The viewing angles are determined for the horizontal or 3,9 o'clock direction and the vertical or 6,12 o'clock direction with respect to the optical axis which is normal to the LCD surface.

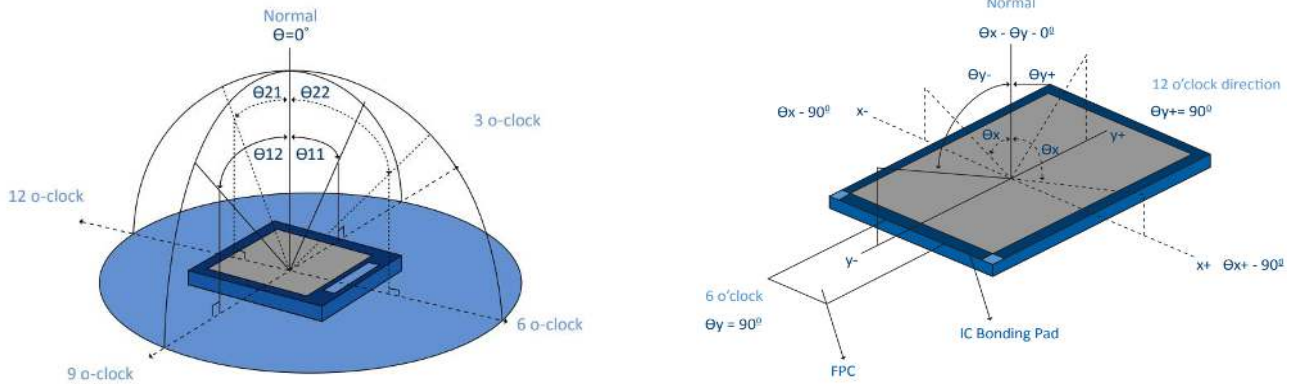

(2) Definition of Contrast Ratio (Cr): measured at the center point of panel. The contrast ratio (Cr) measured on a module, is the ratio between the luminance (Lw) in a full white area (R=G=B=1) and the luminance (Ld) in a dark area (R=G=B=0).

$$Cr = \frac{Lw}{Ld}$$

(3) Definition of transmittance (T%): The transmittance of the panel including the polarizers is measured with electrical driving. The equation for transmittance Tr is:

$$Tr = \frac{I_t}{I_o} \times 100\%$$

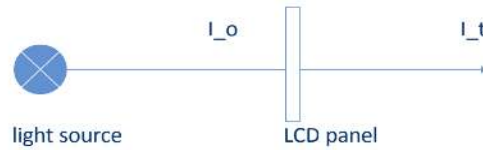

I_o = the brightness of the light source.

I_t = the brightness after panel transmission

(4) Definition of Response Time (Tr, Tf): The rise time 'Tr' is defined as the time for luminance to change from 90% to 10% as a result of a change of the electrical condition. The fall time 'Tf' is defined as the time for luminance to change from 10% to 90% as a result of a change of the electrical condition.

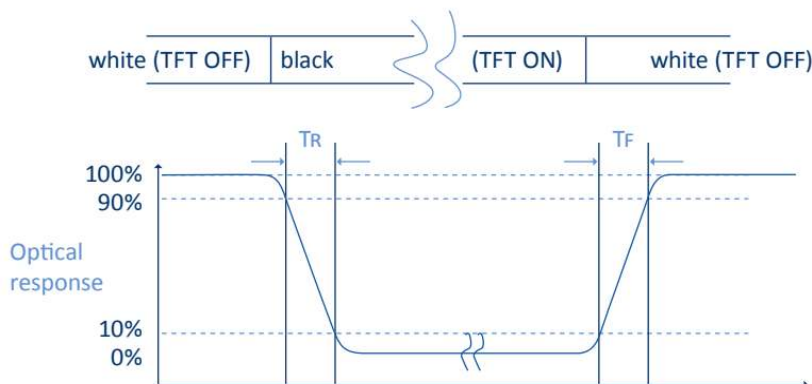

(5) Definition of Color Gamut:

Measuring machine CFT-01. NTSC's Primaries: $R(x,y,Y), G(x,y,Y), B(x,y,Y)$. FPM520 of Westar Display Technologies, INC., which utilized SR-3 for Chromaticity and BM-5A for other optical characteristics. The color chromaticity shall be calculated from the spectral data measured with all pixels first in red, green, blue and white. Measurements shall be made at the center of the panel.

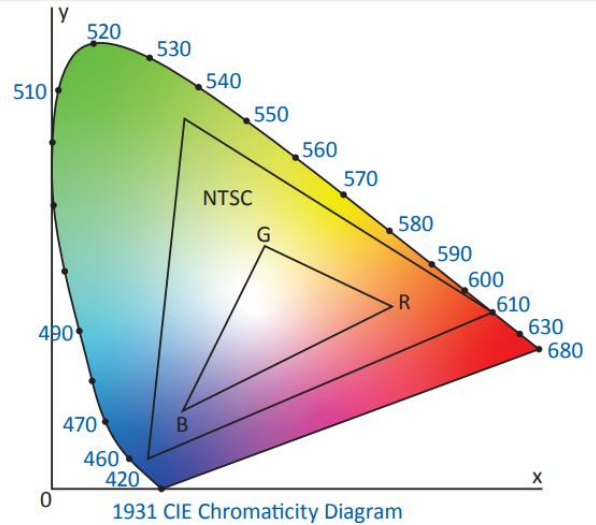
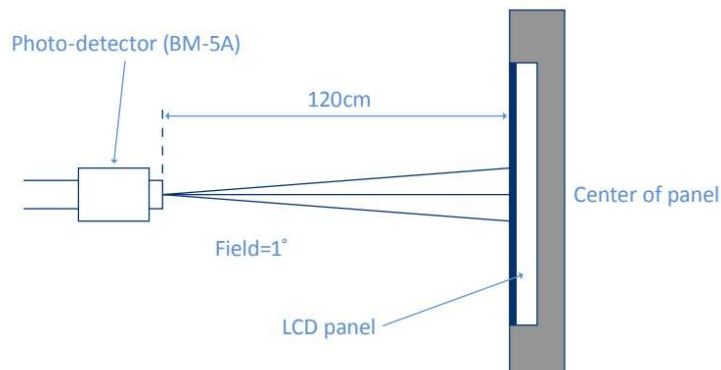
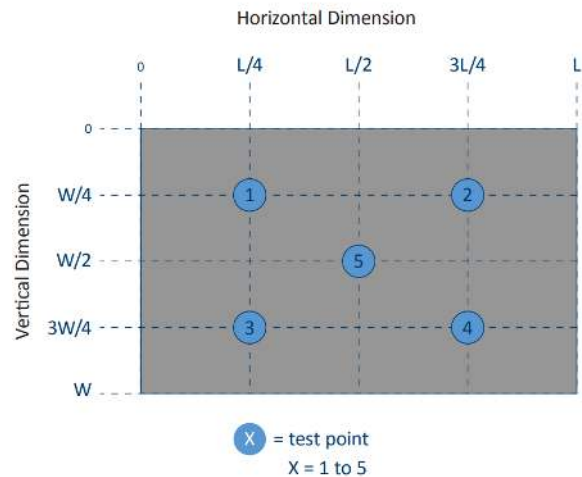
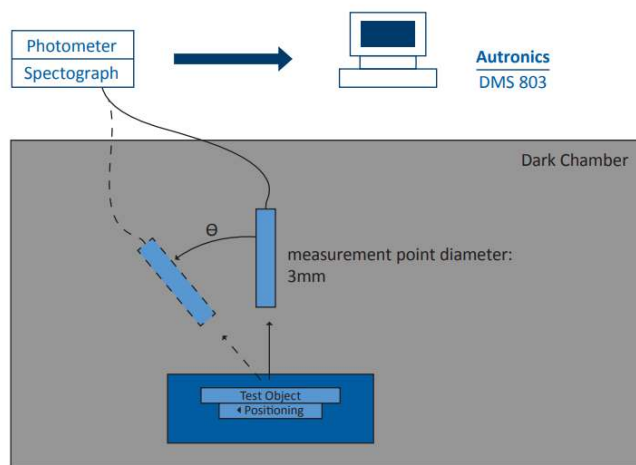

Fig. 1931 CIE chromacity diagram

$$\text{Color gamut: } S = \frac{\text{Area of RGB triangle}}{\text{Area of NTSC triangle}} \times 100\%$$

(6) Definition of Optical Measurement Setup:

The LCD module should be stabilized at a given temperature for 20 minutes to avoid abrupt temperature change during measuring. In order to stabilize the luminance, the measurement should be executed after lighting backlight for 20 minutes.



5. TFT Electrical Characteristics

5.1 Absolute Maximum Rating (Ta=25 °C, VSS=0V)

Characteristics	Symbol	Min	Max	Unit
Digital Supply Voltage	VDD	-0.3	4.0	V
Operating Temperature	TOP	-30	+85	°C
Storage Temperature	TST	-40	+85	°C

NOTE: If the absolute maximum rating of the above parameters is exceeded, even momentarily, the quality of the product may be degraded. Absolute maximum ratings specify the values which the product may be physically damaged if exceeded. Be sure to use the product within the range of the absolute maximum ratings.

5.2 DC Electrical Characteristics

Characteristics	Symbol	Min	Typ.	Max	Unit	Note
Digital Supply Voltage	VDD	3.0	3.3	3.6	V	
Normal Mode Current	IDD	--	31	--	mA	
Level Input Voltage	VIH	0.7VDD	--	VDD	V	
	VIL	GND	--	0.3VDD	V	
Level Output Voltage	VOH	VDD-0.4	--	VDD	V	
	VOL	GND	--	GND+0.4	V	

5.3 LED Backlight Characteristics

Item	Symbol	Min	Typ.	Max	Unit	Note
Forward Current	IF	--	40	--	mA	
Forward Voltage	VF	--	15	--	V	
LCM Luminance	LV	880	920	--	cd/m ²	Note 3
LED lifetime	Hr	--	50000	--	hour	Note1 & 2
Uniformity	AVg	80	--	--	%	Note 3

The back-light system is edge-lighting type with 10 white LEDs.

Note 1: LED lifetime (Hr) can be defined as the time in which it continues to operate under the condition: $T_a=25\pm 3\text{ }^\circ\text{C}$, typical IL value indicated in the above table until the brightness becomes less than 50%.

Note 2: The “LED lifetime” is defined as the module brightness decrease to 50% original brightness at $T_a=25^\circ\text{C}$ and $I_L=8\text{--}40\text{mA}$. The LED lifetime could be decreased if operating I_L is larger than 40mA. The constant current driving method is suggested.

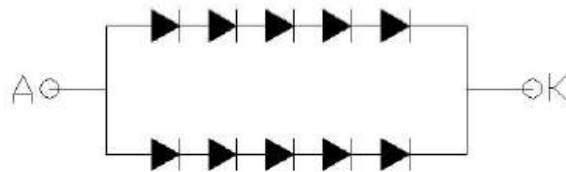

Backlight LED Circuit

Note 3: Luminance Uniformity of these 9 points is defined as below:

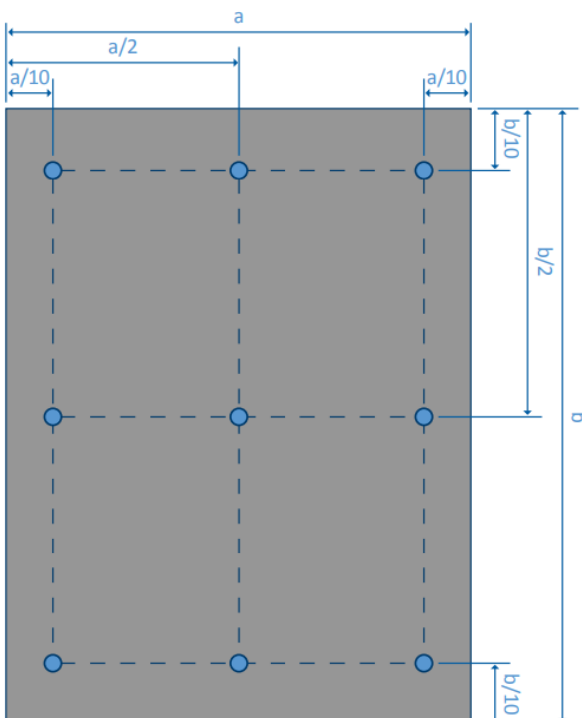

$$\text{Luminance} = \frac{\text{Total Luminance of 9 points}}{9}$$

$$\text{Uniformity} = \frac{\text{minimum luminance in 9 points(1-9)}}{\text{maximum luminance in 9 points(1-9)}}$$

6. AC Characteristics

6.1. 3-wire Serial Interface (3SPI)

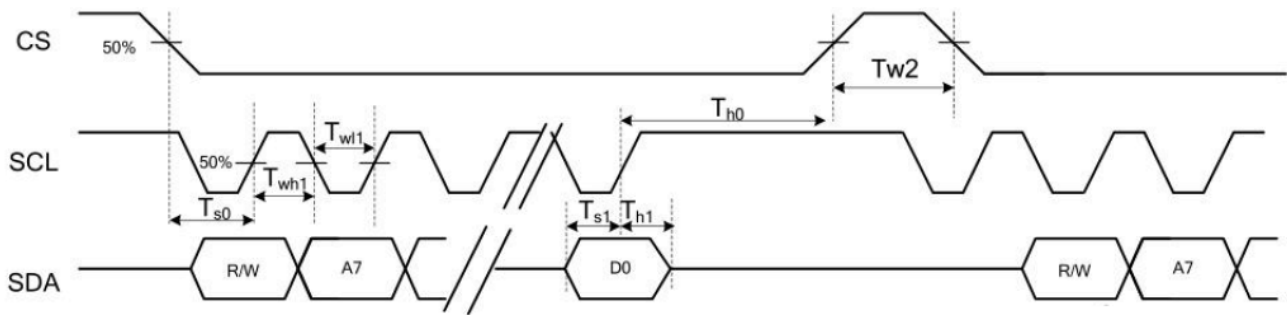

Item	Symbol	Min.	Typ.	Max.	Unit	Conditions
CS Input Setup Time	T_{s0}	50			ns	
Serial Data Input Setup Time	T_{s1}	50			ns	
CS Input Hold Time	T_{h0}	50			ns	
Serial Data Input Hold Time	T_{h1}	50			ns	
SCL Write Pulse High Width	T_{wh1}	50			ns	
SCL Write Pulse Low Width	T_{wl1}	50			ns	
SCL Read Pulse High Width	T_{rh1}	50			ns	
SCL Read Pulse Low Width	T_{rl1}	50			ns	
CS Pulse High Width	T_{w2}	50			ns	

6.2. RGB Data Bus Timing Signals

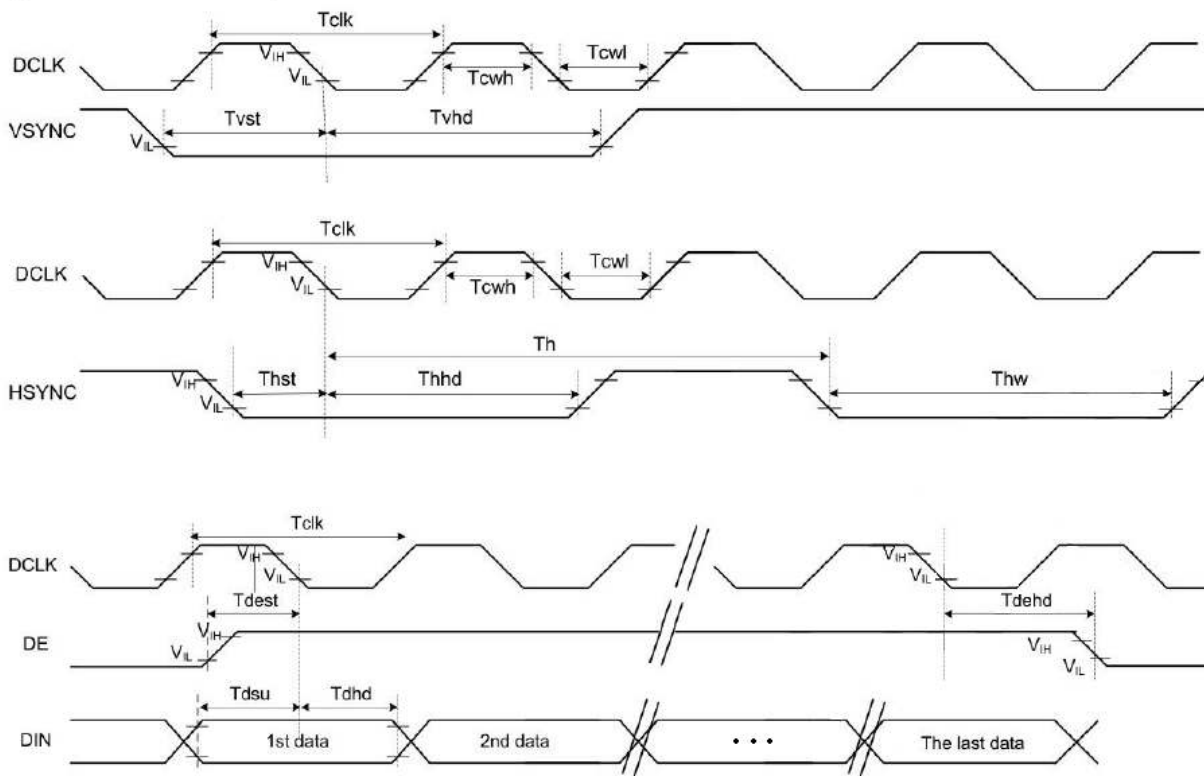

Item	Symbol	Min.	Typ.	Max.	Unit	Conditions
CLK Pulse Duty	T_{clk}	40	50	60	%	
HSYNC Width	T_{hw}	2	-	-	DCLK	
HSYNC Period	T_h	55	60	65	us	
VSYNC Setup Time	T_{vst}	12	-	-	ns	
VSYNC Hold Time	T_{vhd}	12	-	-	ns	
HSYNC Setup Time	T_{hst}	12	-	-	ns	
HSYNC Hold Time	T_{hhd}	12	-	-	ns	
Data Setup Time	T_{dsu}	12	-	-	ns	
Data Hold Time	T_{dhd}	12	-	-	ns	
DE Setup Time	T_{dest}	12	-	-	ns	
DE Hold Time	T_{dehd}	12	-	-	ns	

6.3. RGB SYNC Mode

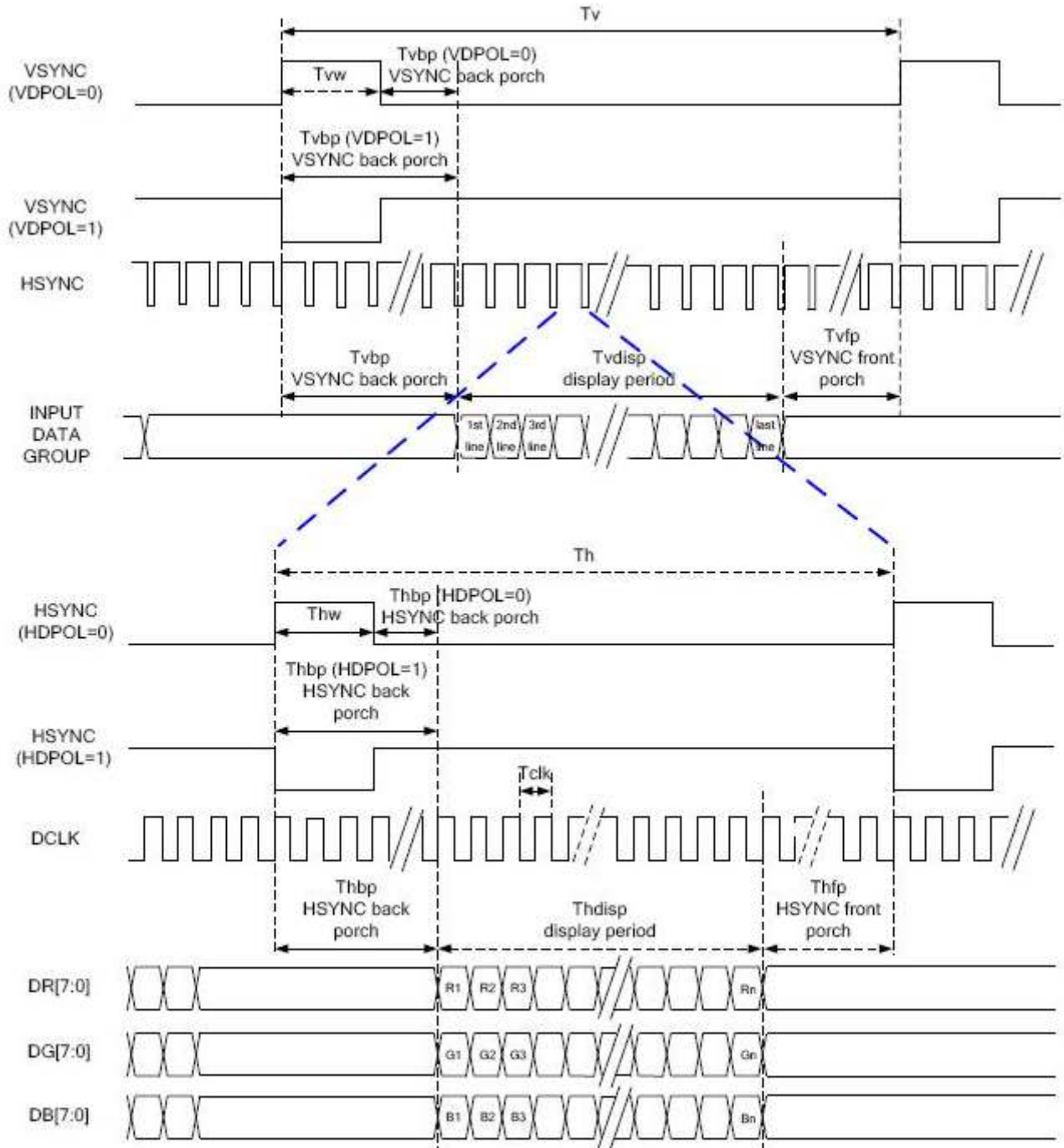

6.4. RGB SYNC-DE Mode

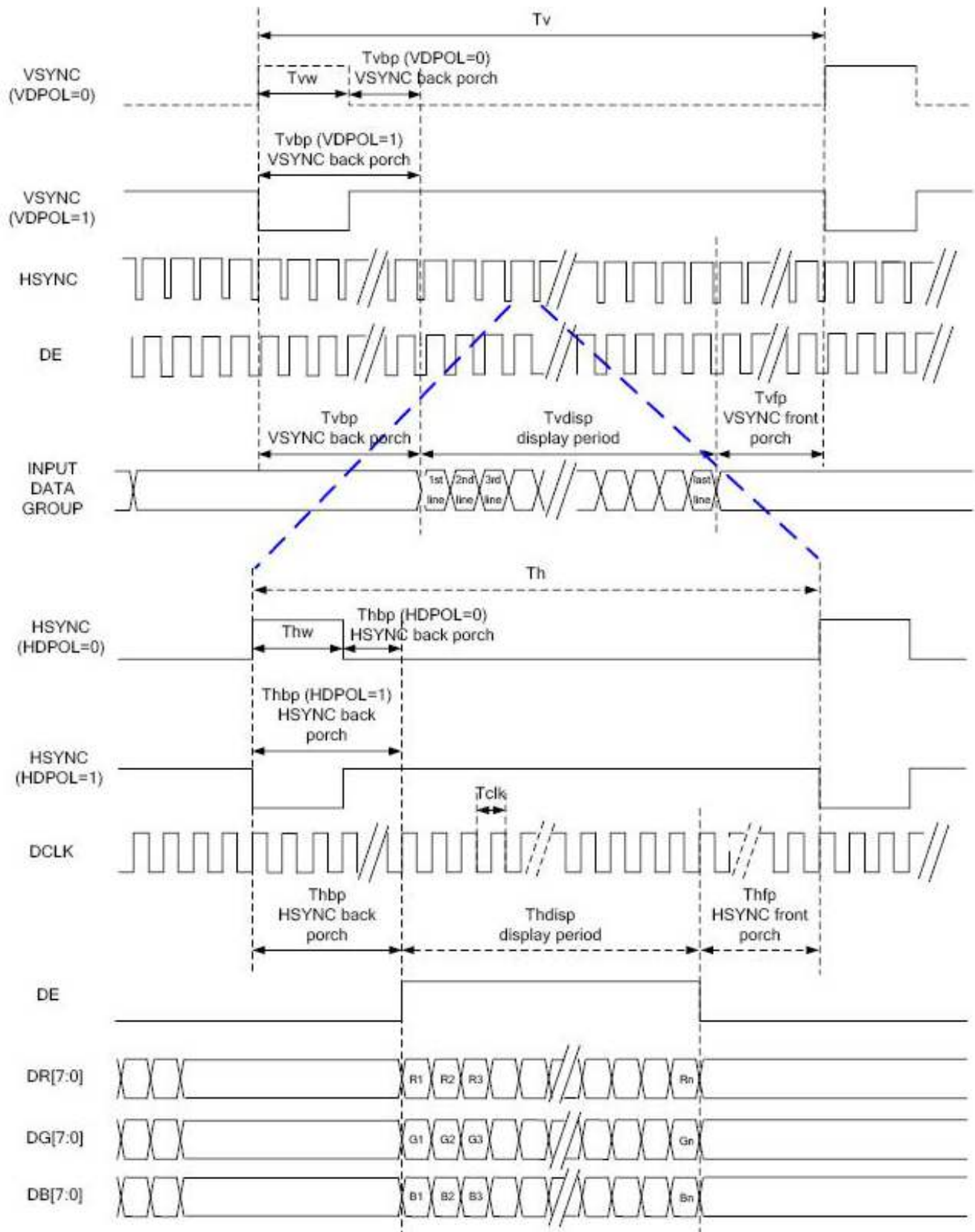

6.5. DE Mode

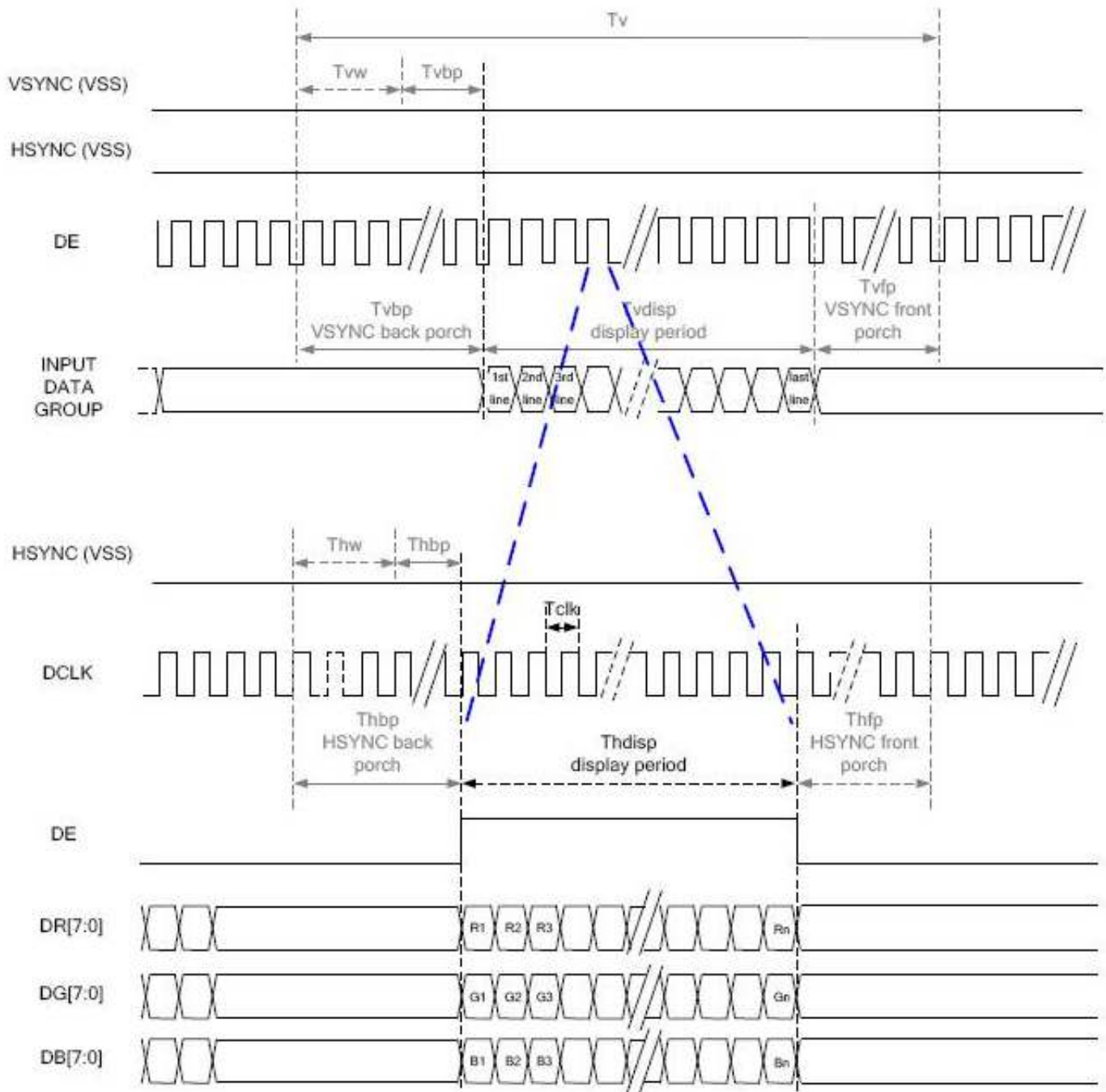

RGB Mode Selection	DCLK	HSYNC	VSYNC	DE
SYNC-DE Mode	Input	Input	Input	Input
SYNC Mode	Input	Input	Input	GND
DE Mode	Input	GND	GND	Input

6.6. 24-bit RGB Timing Table

Item	Symbol	Min.	Typ.	Max.	Unit	Conditions	
DCLK Frequency	Fclk	5	6	8	MHz		
DCLK Period	Tclk	125	167	200	ns		
HSYNC	Period Time	Th	325	371	438	DCLK	
	Display Period	Thdisp	-	320	-	DCLK	
	Back Porch	Thbp	3	43	43	DCLK	H blanking setting
	Front Porch	Thfp	2	8	75	DCLK	
	Pulse Width	Thw	2	4	43	DCLK	
VSYNC	Period Time	Tv	244	260	289	HSYNC	
	Display Period	Tvdisp	-	240	-	HSYNC	
	Back Porch	Tvbp	2	12	12	HSYNC	V blanking setting
	Front Porch	Tvfp	2	8	37	HSYNC	
	Pulse Width	Tvw	2	4	12	HSYNC	

7. Cautions and Handling Precautions

7.1 Handling and Operating the Module

1. When the module is assembled, it should be attached to the system firmly. Do not warp or twist the module during assembly work.
2. Protect the module from physical shock or any force. In addition to damage, this may cause improper operation or damage to the module and back-light unit.
3. Note that polarizer is very fragile and could be easily damaged. Do not press or scratch the surface.
4. Do not allow drops of water or chemicals to remain on the display surface. If you have the droplets for a long time, staining and discoloration may occur.
5. If the surface of the polarizer is dirty, clean it using some absorbent cotton or soft cloth.
6. The desirable cleaners are water, IPA (Isopropyl Alcohol) or Hexane. Do not use ketene type materials (ex. Acetone), Ethyl alcohol, Toluene, Ethyl acid or Methyl chloride. It might permanent damage to the polarizer due to chemical reaction.
7. If the liquid crystal material leaks from the panel, it should be kept away from the eyes or mouth. In case of contact with hands, legs, or clothes, it must be washed away thoroughly with soap.
8. Protect the module from static; it may cause damage to the CMOS ICs.
9. Use fingerstalls with soft gloves in order to keep display clean during the incoming inspection and assembly process.
10. Do not disassemble the module.
11. Protection film for polarizer on the module shall be slowly peeled off just before use so that the electrostatic charge can be minimized.
12. Pins of I/F connector shall not be touched directly with bare hands.
13. Do not connect, disconnect the module in the “Power ON” condition.
14. Power supply should always be turned on/off by the item Power On Sequence & Power Off Sequence.

7.2 Storage and Transportation

1. Do not leave the panel in high temperature, and high humidity for a long time. It is highly recommended to store the module with temperature from 0 to 35 °C and relative humidity of less than 70%
2. Do not store the TFT-LCD module in direct sunlight.
3. The module shall be stored in a dark place. When storing the modules for a long time, be sure to adopt effective measures for protecting the modules from strong ultraviolet radiation, sunlight, or fluorescent light.
4. It is recommended that the modules should be stored under a condition where no condensation is allowed. Formation of dewdrops may cause an abnormal operation or a failure of the module. In particular, the greatest possible care should be taken to prevent any module from being operated where condensation has occurred inside.
5. This panel has its circuitry FPC on the bottom side and should be handled carefully in order not to be stressed.