

0RQB-50Y05x

Isolated DC-DC Converter

The 0RQB-50Y05x is an isolated DC/DC converter providing 50 W of output power from a wide input range (24 / 48 / 72 / 96 / 110 V typical). Standard features include remote on/off, input under-voltage protection, output over-voltage protection, over current and short circuit protection.

This converter can also provide a 5 V/5 mA auxiliary supply. When a large hold-up capacitor is added, the converter can still work up to 12 ms when the input supply is interrupted.

Conformal coated PCB is used for environmental ruggedness.

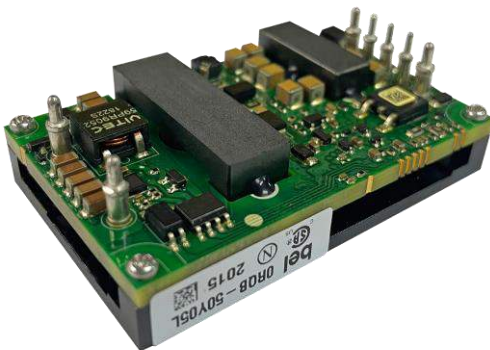

Key Features & Benefits

- 24/48/72/96/110 VDC Input
- 5 VDC @ 10 A Output
- Reinforced Isolation
- High Efficiency
- Hold-Up Function
- Remote On/Off
- Conformal Coated
- Input Over-Voltage Lockout
- Input Under-Voltage Protection
- Output Over-Voltage Protection
- Over Current and Short Circuit Protection
- 5 V Auxiliary Supply at Primary Side
- Wide Input Range (24 V, 48 V, 72 V, 96 V, 110 V typical)
- Approved to IEC/EN 62368-1
- Approved to CSA/UL 62368-1
- Class II, Category 2, Isolated DC/DC Converter (refer to IPC-9592B)

Applications

- Industrial
- Railway

1. MODEL SELECTION

MODEL NUMBER	OUTPUT VOLTAGE	INPUT VOLTAGE	MAX. OUTPUT CURRENT	MAX. OUTPUT POWER	TYPICAL EFFICIENCY
ORQB-50Y05x	5 VDC	24/48/72/96/110 VDC	10 A	50 W	88 % @ 110 V

NOTE: Add "G" suffix at the end of the model number to indicate packaging.

PART NUMBER EXPLANATION

0	R	QB	-	50	Y	05	x	G
Mounting Type	RoHS Status	Series Name		Output Power	Input Range	Output Voltage	Active Logic	Package Type
Through hole mount	RoHS	1/4th Brick		50 W	14.4-154 V	5 V	L- Active low, with baseplate 0- Active high, with baseplate F- Active low, with flange E- Active high, with flange	G – Tray package

2. ABSOLUTE MAXIMUM RATINGS

PARAMETER	DESCRIPTION	MIN	TYP	MAX	UNITS
Continuous non-operating Input Voltage		-0.5	-	200	V
Remote On/Off		-0.3	-	15	V
Operating Temperature	Hot spot temperature, see Thermal Derating Curves section	-40	-	105	°C
Storage Temperature		-55	-	125	°C
Altitude		-	-	5000	m

NOTE: Ratings used beyond the maximum ratings may cause a reliability degradation of the converter or may permanently damage the device.

3. INPUT SPECIFICATIONS

All specifications are typical at 25°C unless otherwise stated.

PARAMETER	DESCRIPTION	MIN	TYP	MAX	UNIT
Operating Input Voltage 1	Fully functioning for long term operation.	14.4	24	154	V
			48		
			72		
			96		
Operating Input Voltage 2	Fully functioning for 0.1s operation. Full function is not guaranteed but undamaged for 1s operation.	12.9	-	14.4	V
			154	-	200
Input Voltage Rising Slope		-	-	2	V/ms
Input Current (full load)		-	-	4.5	A
Input Current (no load)	V _{in} =48V	-	60	90	mA
	V _{in} =110V	-	35	50	mA
Remote Off Input Current		-	-	40	mA
Input Reflected Ripple Current (rms)	With simulated source impedance of 12uH, 5Hz to 20MHz. Use a 100uF/250V electrolytic capacitor with ESR=0.5ohm max, at 200kHz@20°C.	-	-	150	mA
Input Reflected Ripple Current (pk-pk)		-	-	500	mA
Turn-on Voltage Threshold		12.5	13.5	14.4	V
Turn-off Voltage Threshold		11	12	12.9	V
Over-voltage Recovery Threshold		156	160	164	V
Over-voltage Shutdown Threshold		162	165	168	V
Input L/C	Inner inductance	-	3.3	-	uH
	Inner capacitance, C _{total}	-	3.2	-	uF
Input Capacitance	Outside capacitance, typically electrolytic capacitors.	100	-	-	uF
Recommended input fast-acting fuse on system board	CAUTION: This converter is not internally fused. An input line fuse must be used in application.	-	15	-	A

4. OUTPUT SPECIFICATIONS

All specifications are typical at nominal input, full load at 25°C unless otherwise stated.

PARAMETER	DESCRIPTION	MIN	TYP	MAX	UNIT
Output Voltage Set Point		4.9	5	5.1	V
Load Regulation		-	-	20	mV
Line Regulation		-	-	10	mV
Regulation Over Temperature		-	-	±100	mV
Output Ripple and Noise (Pk-Pk)	With a 100 uF ceramic and a 100 uF electrolytic capacitors at output.	-	50	80	mV
Output Ripple and Noise (RMS)		-	10	15	mV
Output Current Range		0	-	10	A
Output DC Current Limit	Enter a hiccup mode, non-latching.	11	-	14	A
Rise Time		-	-	70	ms
Output pre-bias Voltage		0	-	3	V
Start-up Time	Start up from Vin	-	-	1500	ms
	Start up from remote on/off	-	-	150	ms
Overshoot at Turn on		-	0	3	%
Output Capacitance	Typically, 50% ceramic and 50% electrolytic capacitors.	200	-	1000	uF
5V Auxiliary Supply Source Current		-	-	5	mA
Transient Response					
ΔV 50%~75% of Max Load		-	250	350	mV
Settling Time	di/dt=0.1 A/us, with a 100 uF ceramic and a 100 uF electrolytic capacitors near the brick output.	-	0.5	1	ms
ΔV 75%~50% of Max Load		-	250	350	mV
Settling Time		-	0.5	1	ms

5. GENERAL SPECIFICATIONS

PARAMETER	DESCRIPTION	MIN	TYP	MAX	UNIT
Efficiency	Vin = 24 V, Iout = 10 A at 25°C	-	86	-	%
	Vin = 48 V, Iout = 10 A at 25°C	-	87	-	%
	Vin = 110 V, Iout = 10 A at 25°C	-	88	-	%
Switching Frequency	1st stage	-	150	-	kHz
	2nd stage	-	250	-	kHz
Over Temperature Protection	Temperature measured at semiconductor component	-	125	-	°C
Over Voltage Protection (Static)	Enter a latching, non-hiccup mode	-	6	-	V
FIT	Calculated Per Bell Core SR-332	-	193.7	-	-
MTBF	(Vin = 48 V, Vo = 5 V, Io = 10 A Ta=40°C, FIT=10 ⁹ /MTBF)	-	5.162	-	Mhrs
Weight	Baseplate version	-	63	-	g
	Flange version	-	71	-	g
Dimensions (L x W x H)	Baseplate version	2.30 x 1.45x 0.59			inch
		58.42 x 36.83 x 15.00			mm
	Flange version	2.386 x 2.20 x 0.59			inch
		60.60 x 55.88 x 15.00			mm
Isolation Characteristics					
Input to Output		-	-	3000	Vdc
Input to Heatsink		-	-	3000	Vdc
Output to Heatsink		-	-	3000	Vdc
Isolation Resistance	Test with 500 VDC	100M	-	-	Ohm
Isolation Capacitance		-	-	2200	pF

6. EFFICIENCY DATA

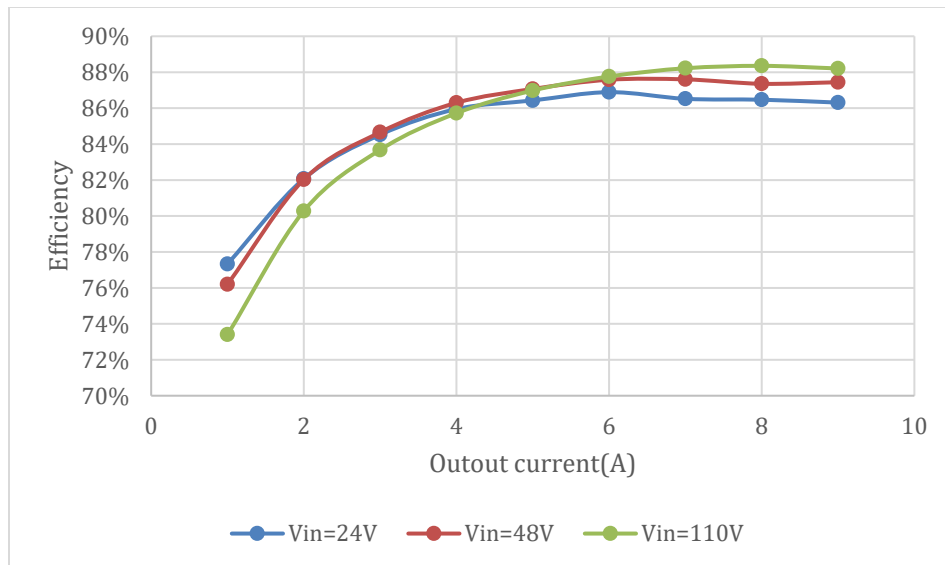

Figure 1. Efficiency data



Asia-Pacific
+86 755 298 85888

Europe, Middle East
+353 61 225 977

North America
+1 408 785 5200

7. REMOTE ON/OFF

PARAMETER		DESCRIPTION	MIN	TYP	MAX	UNIT
Signal Low (Unit On)	Active Low	Remote On/Off pin is open, the module is off	-0.3	-	0.8	V
Signal High (Unit Off)			2.4	-	15	V
Signal Low (Unit Off)	Active High	Remote On/Off pin is open, the module is on.	-0.3	-	0.8	V
Signal High (Unit On)			2.4	-	15	V
Current Sink			0	-	1	mA

Recommended remote on/off circuit for active low

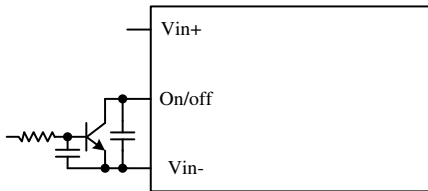

Figure 2. Control with open collector/drain circuit

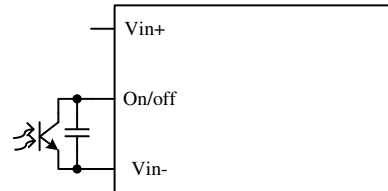

Figure 3. Control with photocoupler circuit

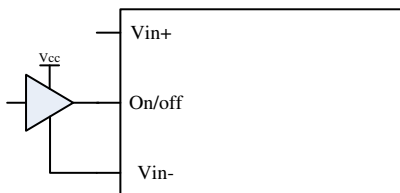

Figure 4. Control with logic circuit

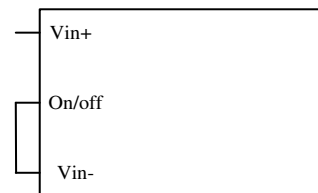

Figure 5. Permanently on

Recommended remote on/off circuit for active high

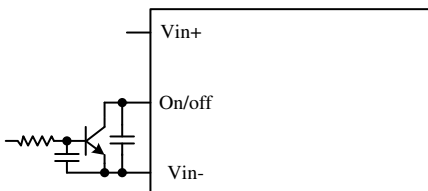

Figure 6. Control with open collector/drain circuit

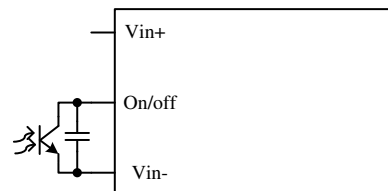

Figure 7. Control with photocoupler circuit

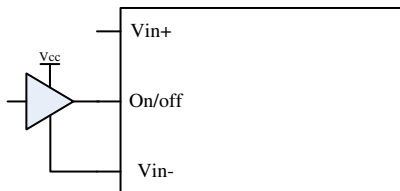

Figure 8. Control with logic circuit

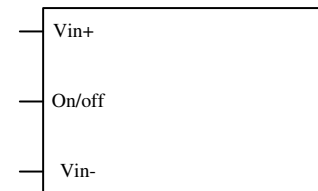

Figure 9. Permanently on

8. INPUT NOISE

Input reflected ripple current.

Testing setup:

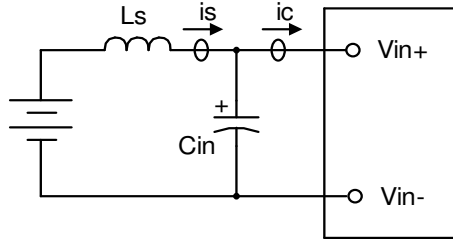

Figure 10. Test setup

Notes and values in testing:

is: Input Reflected Ripple Current

ic: Input Terminal Ripple Current

Ls: Simulated Source Impedance (12μH)

Cin: Electrolytic capacitor, should be as closed as possible to the power module to damped ic ripple current and enhance stability.

Recommendation: 100μF, ESR<0.5R @ 100 kHz, 20°C

Below measured waveforms are based on above simulated and recommended inductance and capacitance.

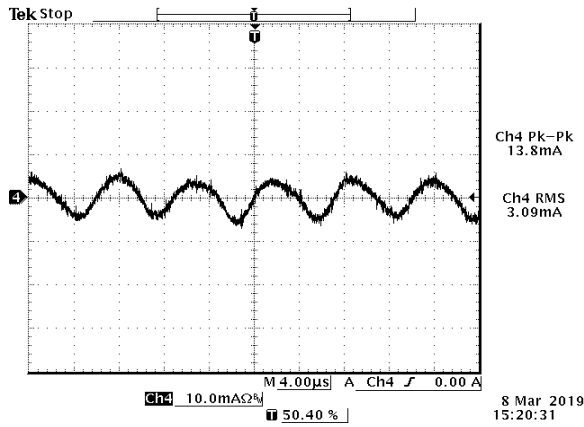

Figure 11. is (input reflected ripple current), AC component

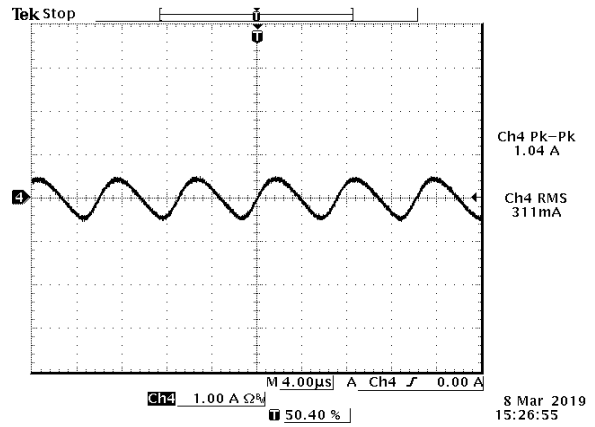

Figure 12. ic (input terminal ripple current), AC component

Test condition: 48Vdc input, 5Vdc/10A output and Ta=25 deg C, with 200μF capacitor at output

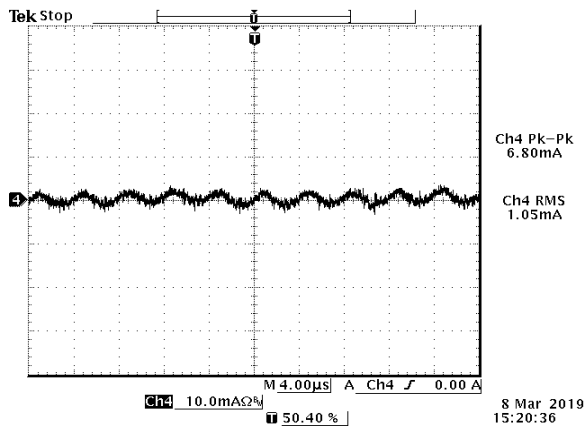

Figure 13. is (input reflected ripple current), AC component

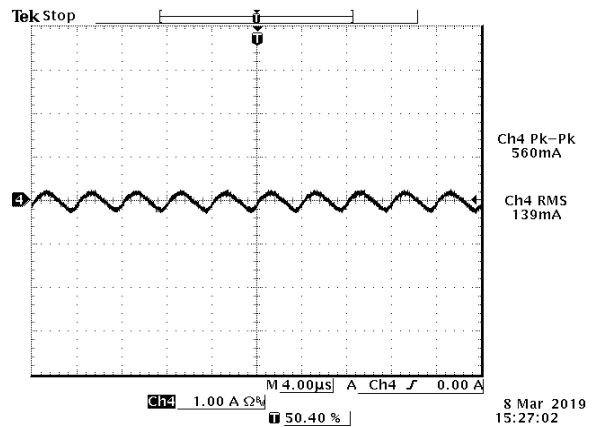

Figure 14. ic (input terminal ripple current), AC component

Test condition: 110Vdc input, 5Vdc/10A output and Ta=25 deg C, with 200μF capacitor at output

9. RIPPLE AND NOISE WAVEFORMS

TESTING SETUP

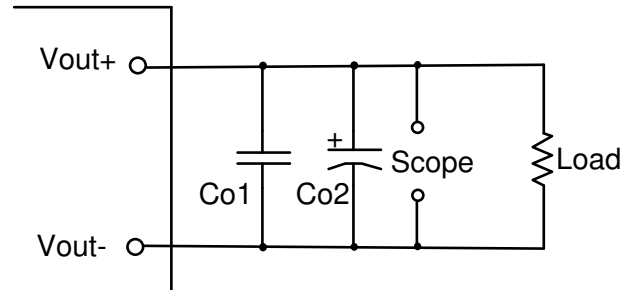

Figure 15.

Notes and values in testing:

Co1: 100 uF ceramic capacitor

Co2: 100 uF POSCAP capacitor

The capacitor should be as closed as possible to the power module to swallow ripple current and help with stability.

Below measured waveforms are based on above capacitance.

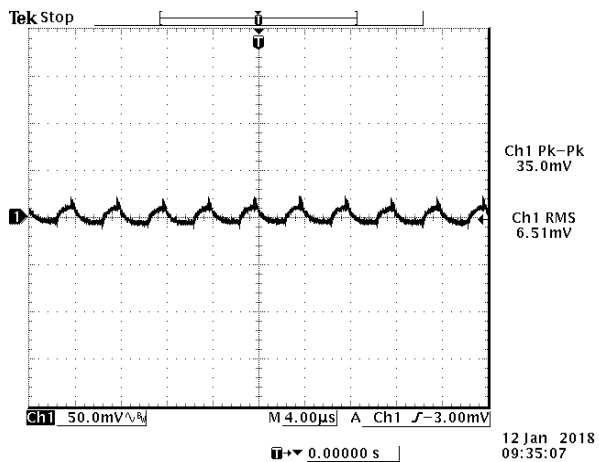

Figure 16. Ripple and noise at $V_{in} = 48\text{ V}$
5 Vdc/10 A output @ $T_a = 25^\circ\text{C}$ with $C_{ext} = 200\text{ }\mu\text{F}$

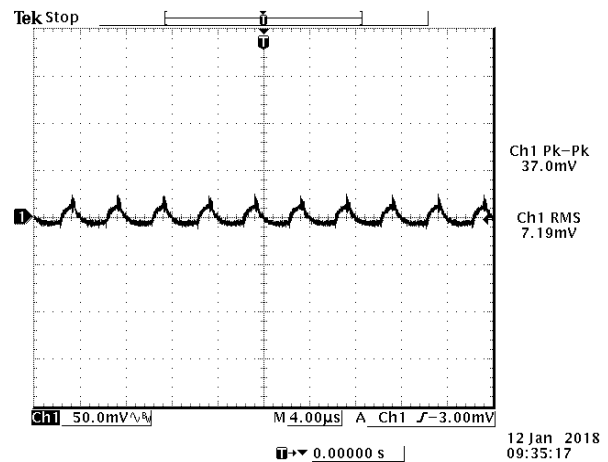

Figure 17. Ripple and noise at $V_{in} = 110\text{ V}$
5 Vdc/10 A output @ $T_a = 25^\circ\text{C}$ with $C_{ext} = 200\text{ }\mu\text{F}$

10. TRANSIENT RESPONSE WAVEFORMS

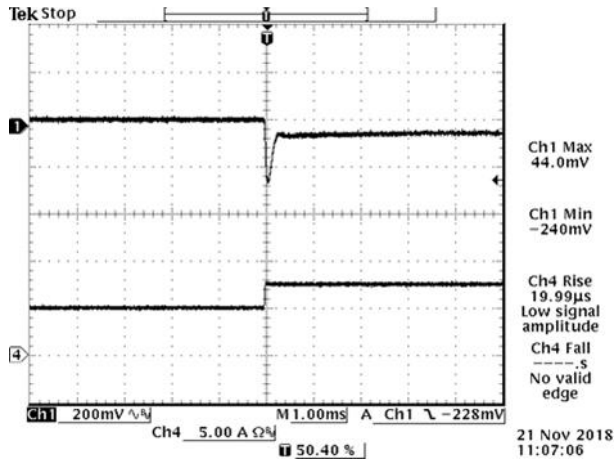

Figure 18. 50%-75% Load Transients at $V_{in} = 48\text{ V}$ @ $T_a = 25^\circ\text{C}$ with $C_{ext} = 200\ \mu\text{F}$

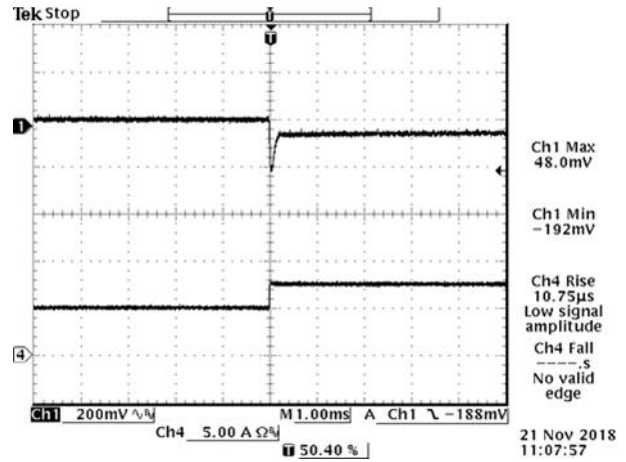

Figure 19. 50%-75% Load Transients at $V_{in} = 110\text{ V}$ @ $T_a = 25^\circ\text{C}$ with $C_{ext} = 200\ \mu\text{F}$

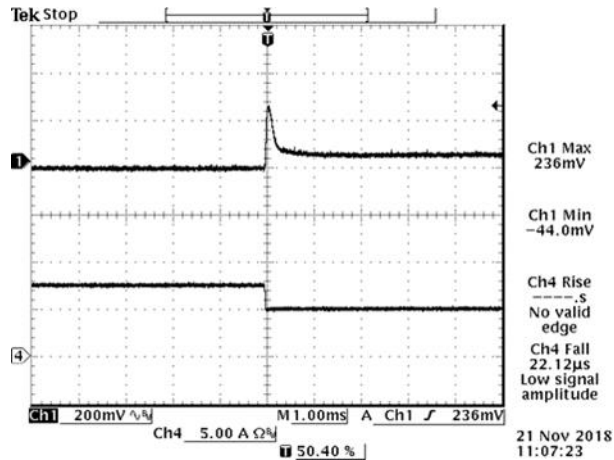

Figure 20. 75%-50% Load Transients at $V_{in} = 48\text{ V}$ @ $T_a = 25^\circ\text{C}$ with $C_{ext} = 200\ \mu\text{F}$

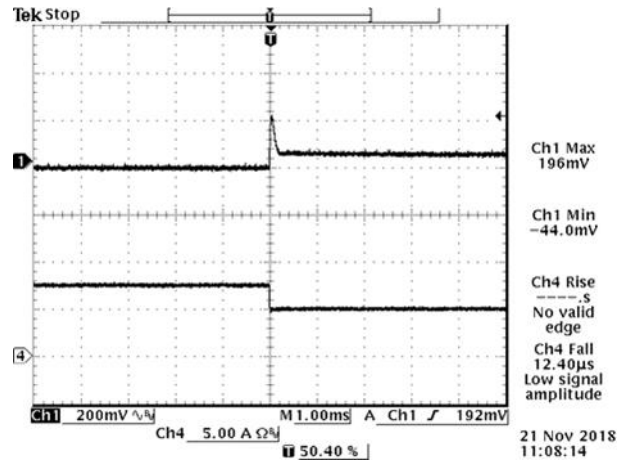

Figure 21. 75%-50% Load Transients at $V_{in} = 110\text{ V}$ @ $T_a = 25^\circ\text{C}$ with $C_{ext} = 200\ \mu\text{F}$

11. STARTUP & SHUTDOWN

Turn on rise time

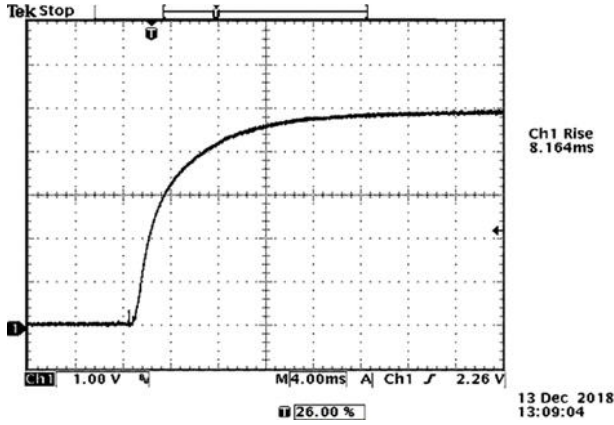

Figure 22. $V_{in}=48V$, $I_o=10A$, $V_o=5V$ with $C_{ext}=200\mu F$

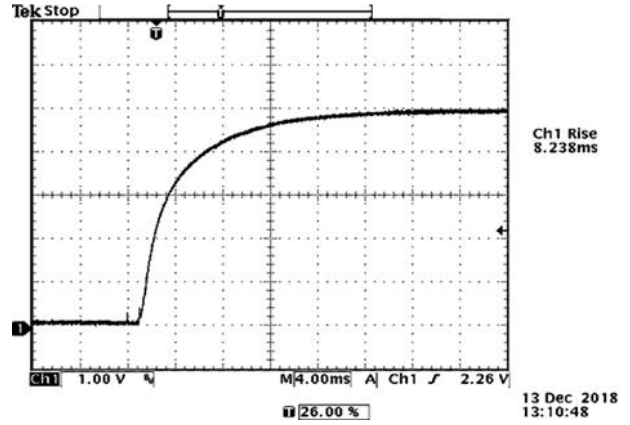

Figure 23. $V_{in}=110V$, $I_o=10A$, $V_o=5V$ with $C_{ext}=200\mu F$

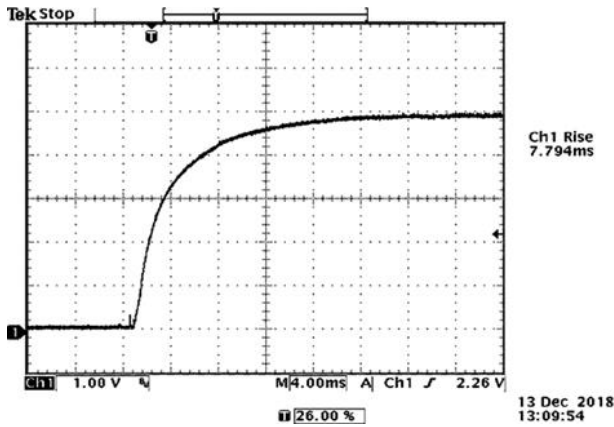

Figure 24. $V_{in}=48V$, $I_o=10A$, $V_o=5V$ with $C_{ext}=1200\mu F$

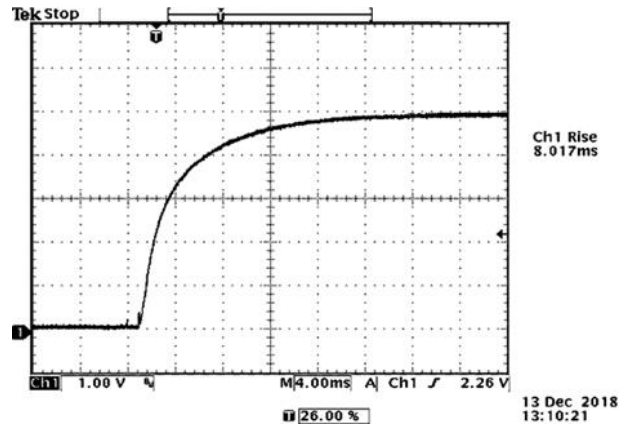

Figure 25. $V_{in}=110V$, $I_o=10A$, $V_o=5V$ with $C_{ext}=1200\mu F$

Turn on delay time

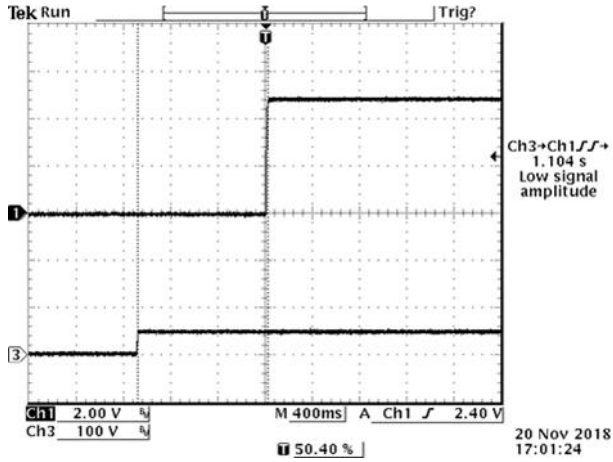

Figure 26. Startup from Vin

Ch1: Vo
Ch3: Vin

Test Condition: Vin=48V, Io=10A, Vo=5V with Cext=200uF

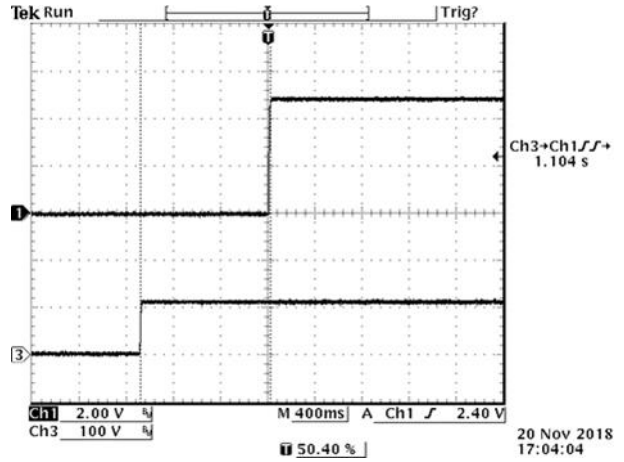

Figure 27. Startup from Vin

Ch1: Vo
Ch3: Vin

Test Condition: Vin=110V, Io=10A, Vo=5V with Cext=200uF

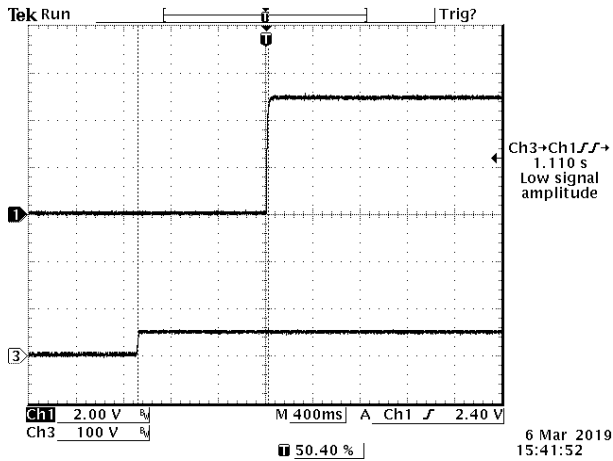

Figure 28. Startup from Vin

Ch1: Vo
Ch3: Vin

Test Condition: Vin=48V, Io=10A, Vo=5V with Cext=1200uF

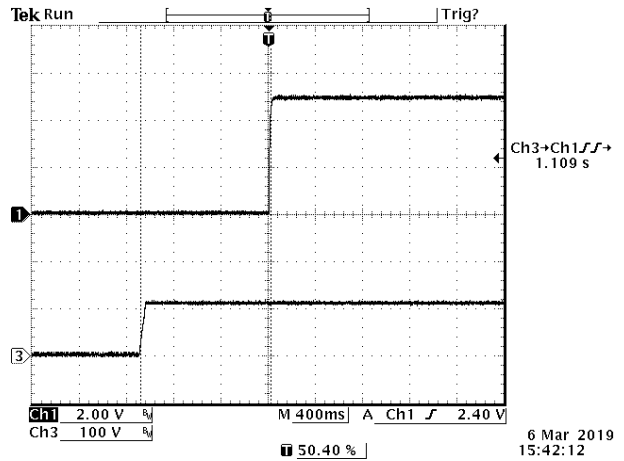

Figure 29. Startup from Vin

Ch1: Vo
Ch3: Vin

Test Condition: Vin=110V, Io=10A, Vo=5V with Cext=1200uF

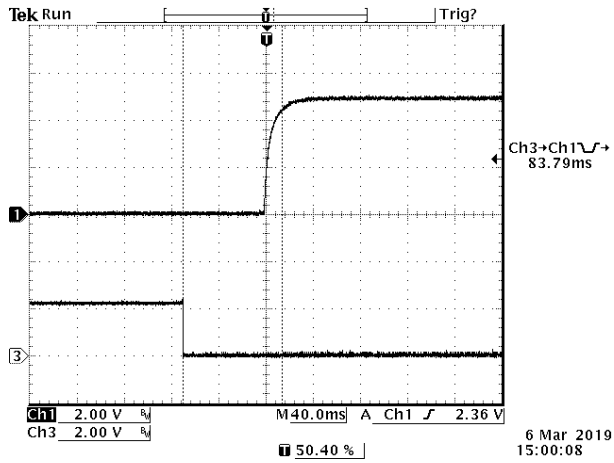

Figure 30. Startup from on/off
 Ch1: Vo
 Ch3: on/off
 Test Condition: Vin=48V, Io=10A, Vo=5V with Cext=200uF

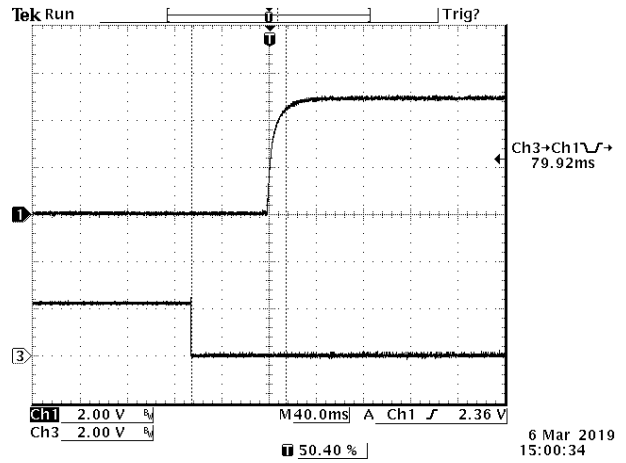

Figure 31. Startup from on/off
 Ch1: Vo
 Ch3: on/off
 Test Condition: Vin=110V, Io=10A, Vo=5V with Cext=200uF

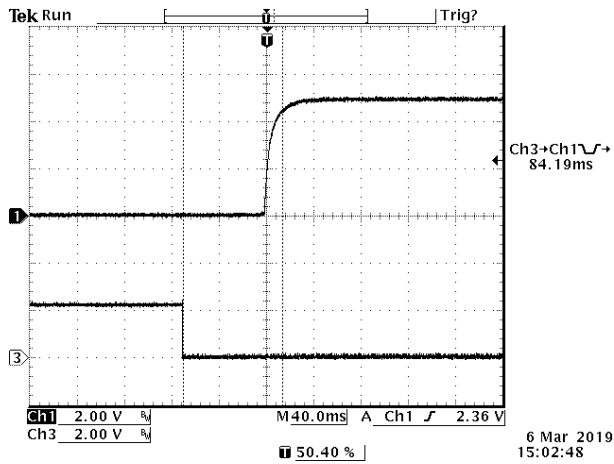

Figure 32. Startup from on/off
 Ch1: Vo
 Ch3: on/off
 Test Condition: Vin=48V, Io=10A, Vo=5V with Cext=1200uF

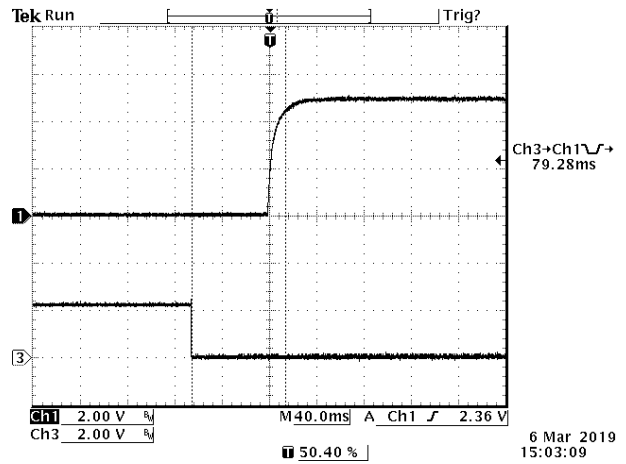

Figure 33. Startup from on/off
 Ch1: Vo
 Ch3: on/off
 Test Condition: Vin=110V, Io=10A, Vo=5V with Cext=1200uF

Shut down time

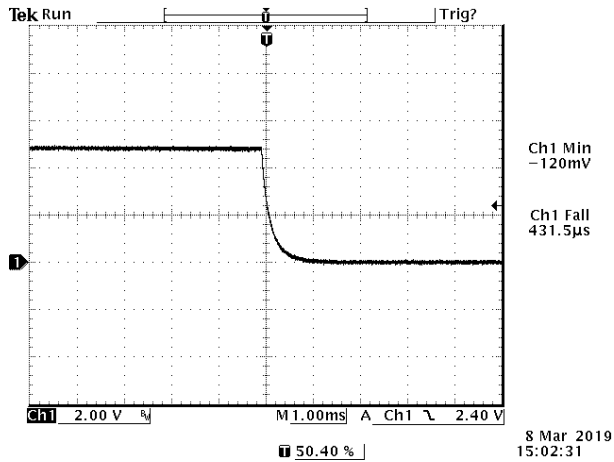

Figure 34. Typical Shut down From Vin

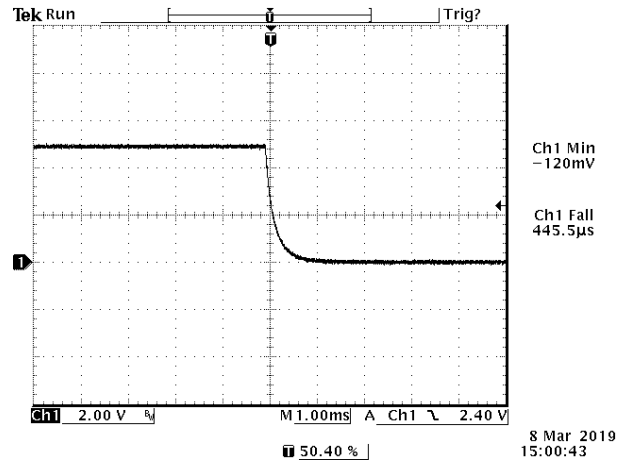

Figure 35. Typical Shut down From Venable

Test Condition: 48Vdc input, 5Vdc/10A output and Ta=25 deg C, with 200µF capacitor at output

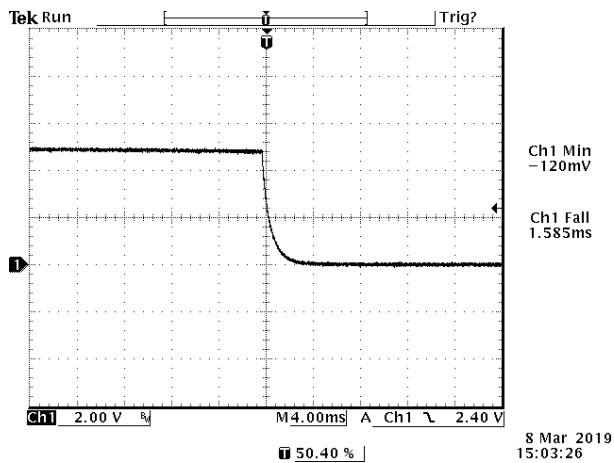

Figure 36. Typical Shut down From Vin

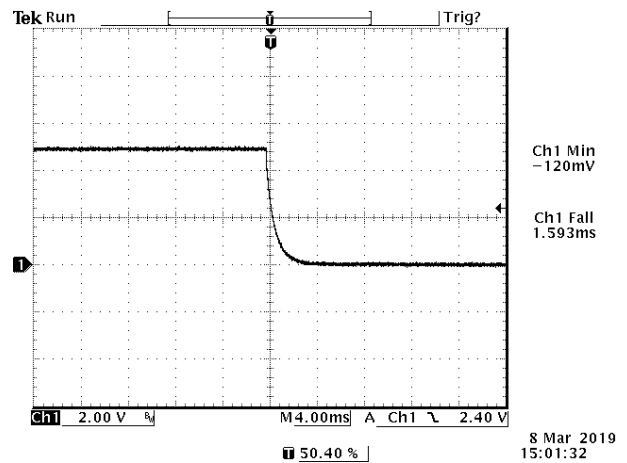

Figure 37. Typical Shut down From Venable

Test Condition: 48Vdc input, 5Vdc/10A output and Ta=25 deg C, with 1200µF capacitor at output

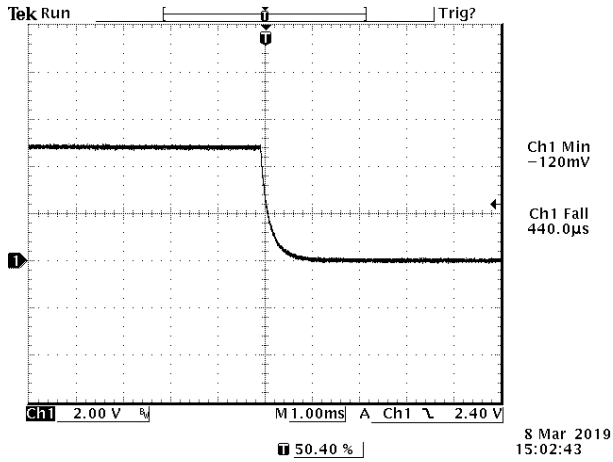

Figure 38. Typical Shut down From Vin

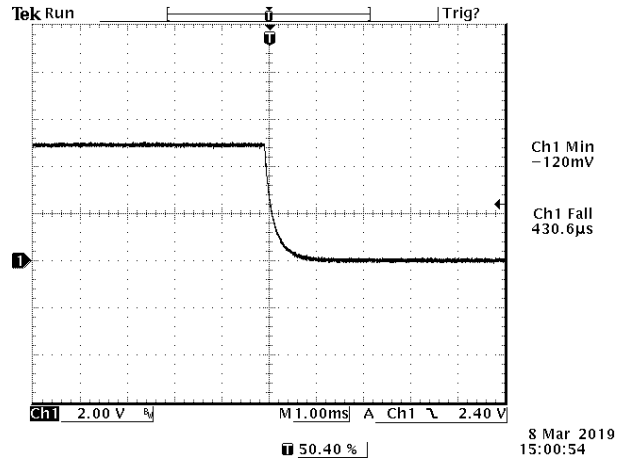

Figure 39. Typical Shut down From Venable

Test Condition: 110Vdc input, 5Vdc/10A output and Ta=25 deg C, with 200µF capacitor at output

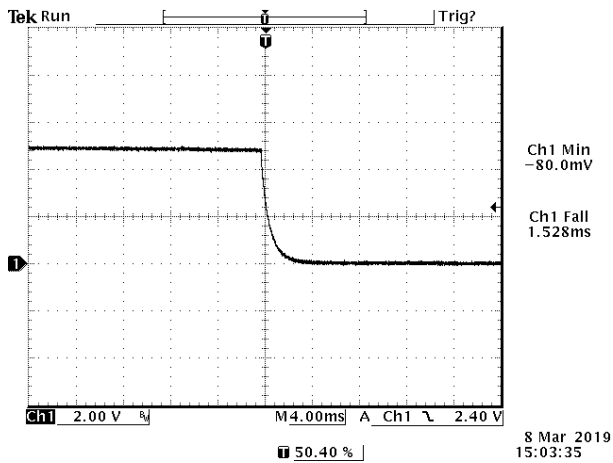

Figure 40. Typical Shut down From Vin

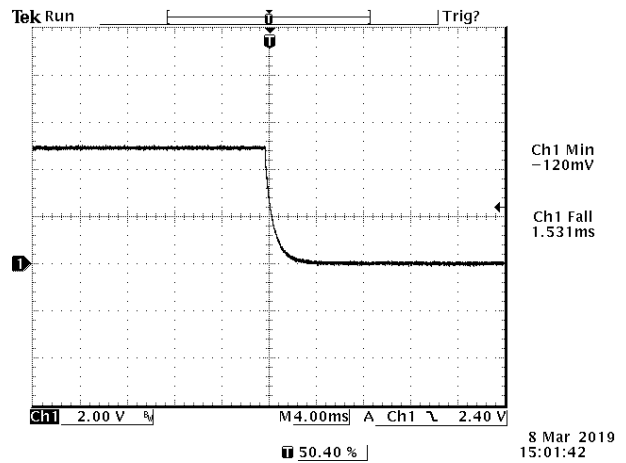

Figure 41. Typical Shut down From Venable

Test Condition: 110Vdc input, 5Vdc/10A output and Ta=25 deg C, with 1200µF capacitor at output

12. OVER CURRENT PROTECTION

Hiccup: To provide protection in a fault output overload condition, the module is equipped with internal current-limiting circuitry and can endure current limiting for a few milliseconds. If the overcurrent condition persists beyond a few milliseconds, the module will shut down into hiccup mode and restart once every 1600ms. The module operates normally when the output current goes into specified range.

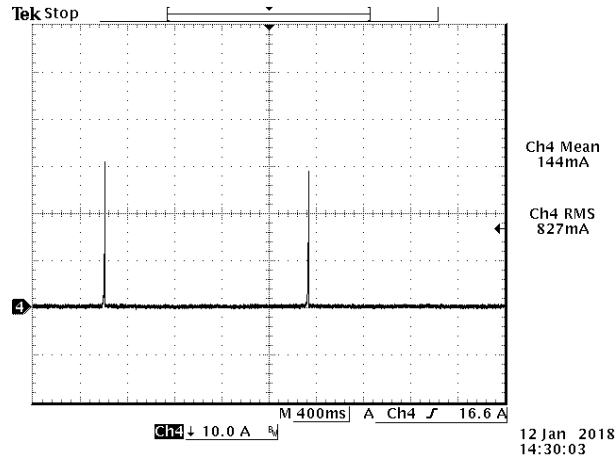

Figure 42. Over current protection

13. INPUT UNDER VOLTAGE LOCKOUT

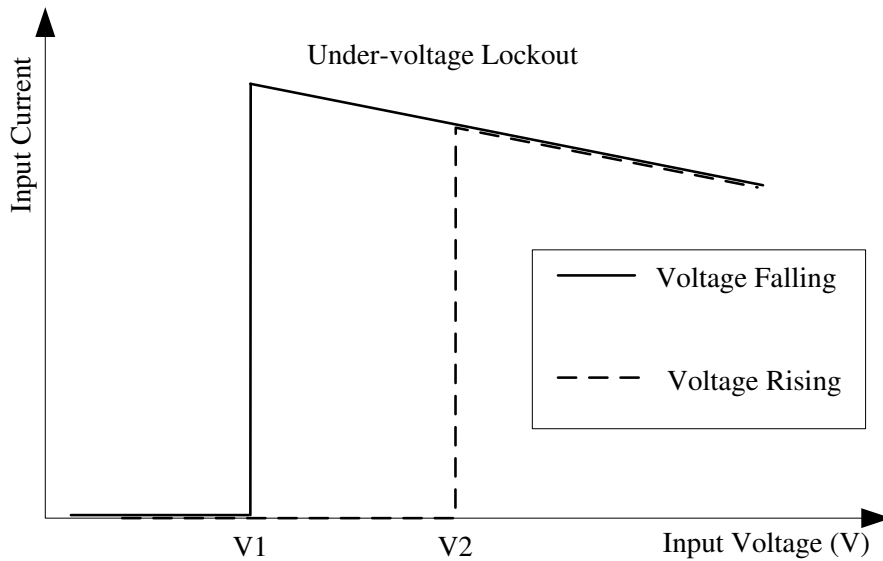
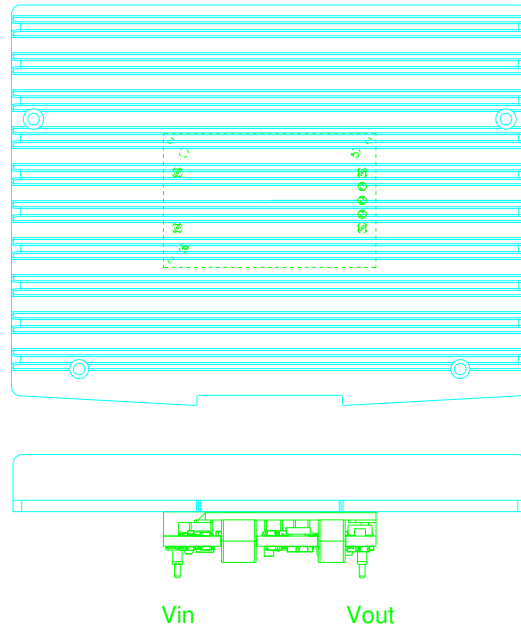

Figure 43. Input under voltage lockout
 $V1 = 12V$
 $V2 = 13.5V$

14. THERMAL DERATING CURVE

Test setup: Vin=24V,48V,110V, OLFM, external HSK Dimension: 142 x 110 x 16 mm



HSK Dimension:142x110x16mm (16 includes baseplate and ribs)

Figure 44. Thermal test setup

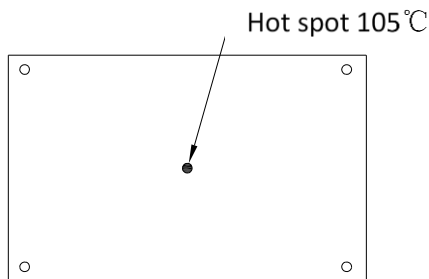

Figure 45. Hot spot

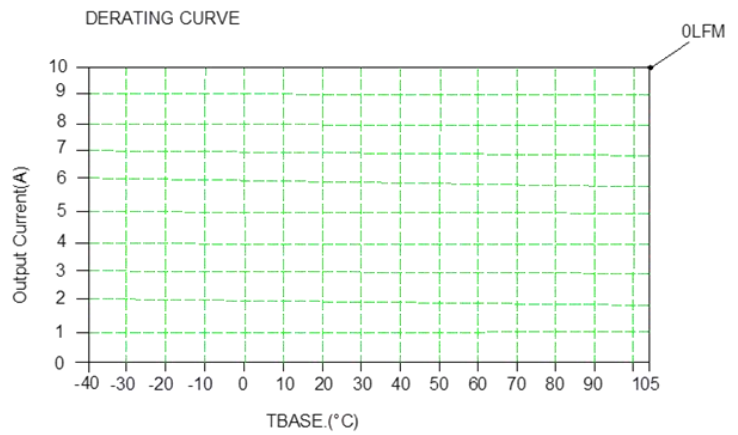

Figure 46. Thermal derating curve

15. HOLD UP CAPACITOR

Recommended external hold up circuit (Option 1)

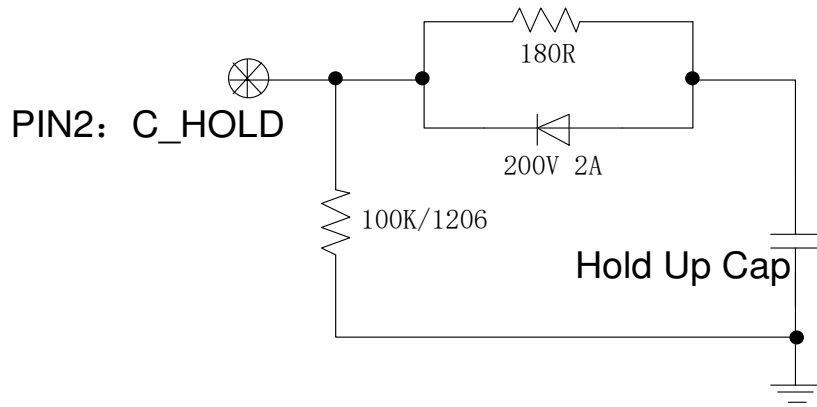

Figure 47. Recommended external hold up circuit-1

NOTE: The rated power of the current-limiting resistor 180R is determined by the rise slope of the input voltage.

PARAMETER	NOTES	SYMBOL	MIN	TYP	MAX	UNITS
Hold up capacitor	Working voltage rating should be 200 V. Caution: This capacitor is necessary for both normal & hold up operation.	C_HOLD	100	470	-	uF
Hold up voltage	Normal operation	V_HOLD	40	80	154	V
Hold up time	14.4-154 V input and all output range.	T_HOLD	-	12	-	ms

Recommended external hold up circuit (Option 2)

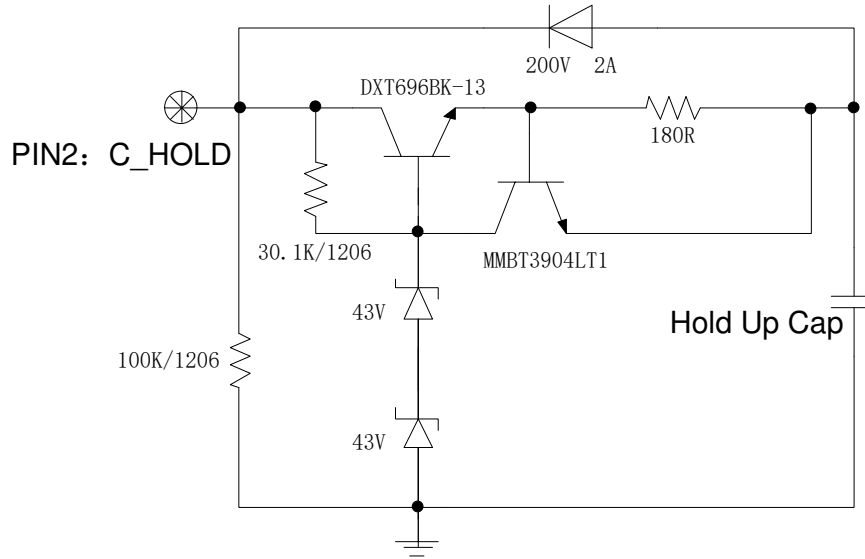

Figure 48. Recommended external hold up circuit-2

NOTE: The rated power of the current-limiting resistor 180R is determined by the rise slope of the input voltage.

PARAMETER	NOTES	SYMBOL	MIN	TYP	MAX	UNITS
Hold up capacitor	Working voltage rating should be 100V. Caution: This capacitor is necessary for both normal and hold up operation.	C_HOLD	100	470	-	uF
Hold up voltage	Normal operation	V_HOLD	40	80	86	V
Hold up time	14.4-154 V input and all output range.	T_HOLD	-	12	-	ms

16. SAFETY & EMC SPECIFICATIONS

Safety:

1. Material flammability UL94V-0
2. Nemko certification EN 62368-1
3. CSA certification CSA/UL 62368-1
4. CB certification IEC/EN 62368-1

EMC

1. Conductive EMI: EN 55032 class A

Compliance to EN 55032 class A (both peak and average) with the following inductive and capacitive filter

Setup:

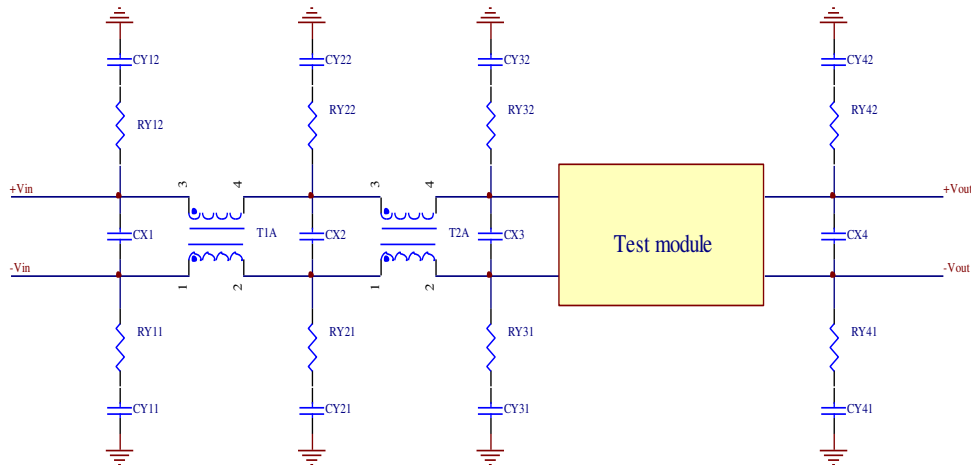

Figure 49.

ITEM	DESIGNATOR	PARAMETER	VENDOR	VENDOR P/N
1	CX2	1 μ F/305V, X2		
2	CX3	100 μ F/200V, AL cap		
3	CX4	2*100 μ F/16V, tantalum capacitor		
4	CY31	4700PF, Y2		
5	CY32	4700PF, Y2		
6	RY31	1206,0R, Resistor		
7	RY32	1206,0R, Resistor		
8	T2A	2.4mH, common mode inductance		

Positive

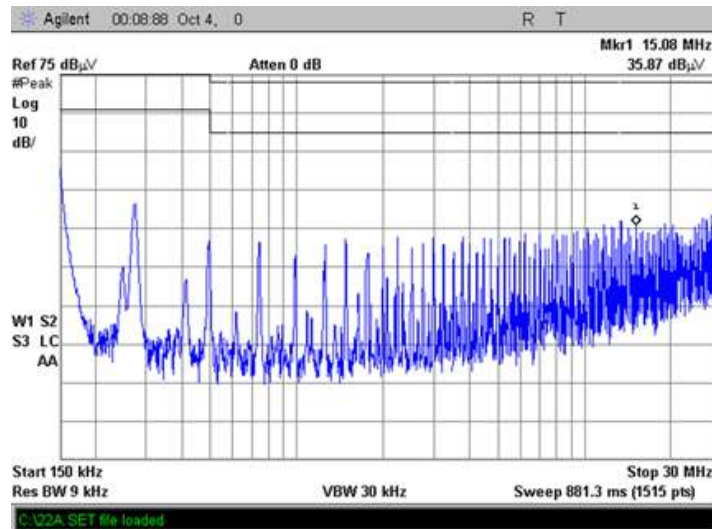

Figure 50.

Negative

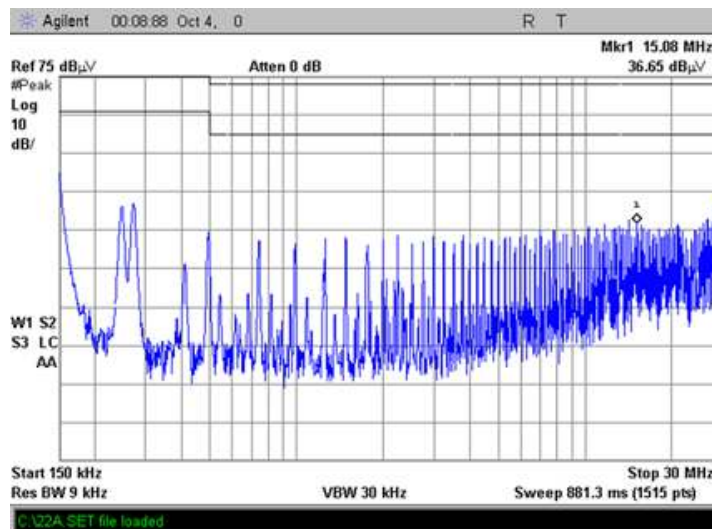

Figure 51.

17. MECHANICAL DIMENSIONS

ORQB-50Y05L/0 OUTLINE

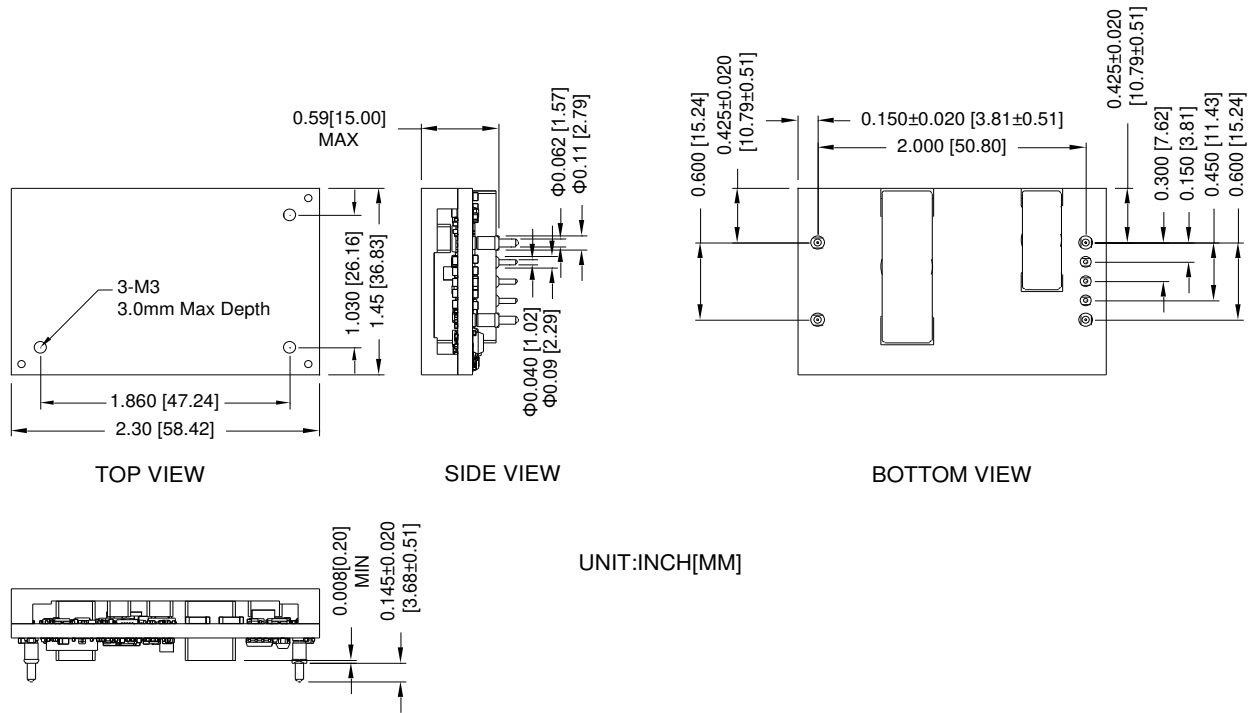

Figure 52. ORQB-50Y05L/0 Outline

Note: This module is recommended and compatible with Pb-Free Wave Soldering and must be soldered using a peak solder temperature of no more than 260 °C for less than 5 seconds.

Notes:

- 1) All Pins: Material - Copper Alloy;
Finish - Tin plated.
- 2) Un-dimensioned components are shown for visual reference only.
- 3) All dimensions in inches; Tolerances: x.xx +/-0.02 in [0.5 mm]. x.xxx +/-0.010 in [0.25 mm]. Unless otherwise stated.

0RQB-50Y05L/0 PIN DEFINITIONS

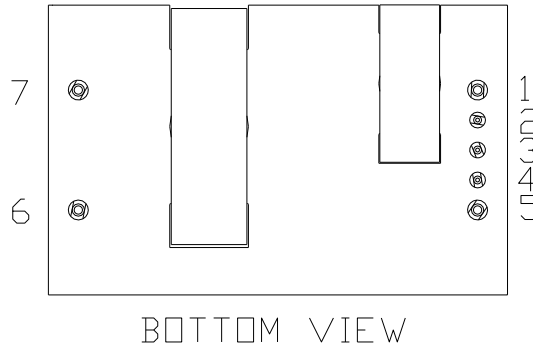

Figure 53. 0RQB-50Y05L/0 Pins

PIN	FUNCTION	PIN	FUNCTION
1	Vin (+)	5	Vin (-)
2	C_HOLD	6	Vout (-)
3	ON/OFF	7	Vout (+)
4	V_AUX(5V)		

0RQB-50Y05L/0 RECOMMENDED PAD LAYOUT

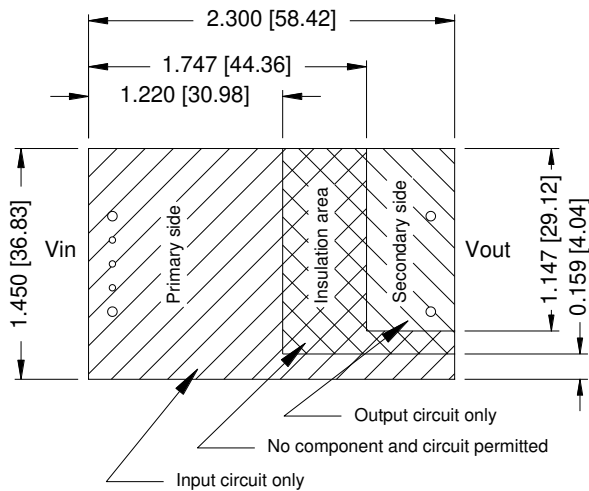

Figure 54. 0RQB-50Y05L/0 Recommended pad layout-1

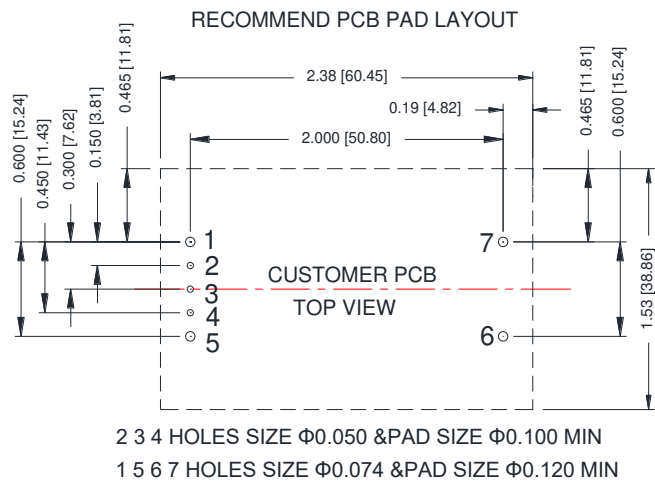

Figure 55. 0RQB-50Y05L/0 Recommended pad layout-2

ORQB-50Y05E/F OUTLINE

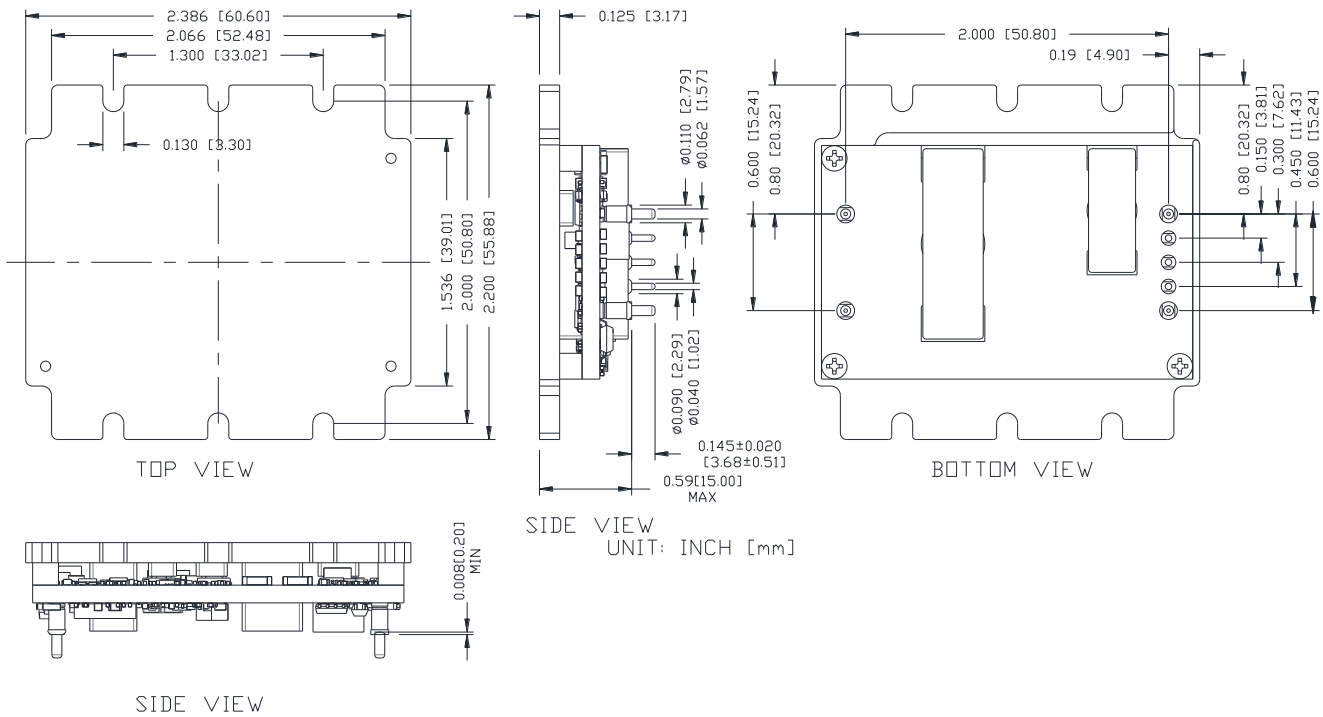

Figure 56. ORQB-50Y05E/F Outline

Note: This module is recommended and compatible with Pb-Free Wave Soldering and must be soldered using a peak solder temperature of no more than 260 °C for less than 5 seconds.

Notes:

- 1) All Pins: Material - Copper Alloy;
Finish - Tin plated.
- 2) Un-dimensioned components are shown for visual reference only.
- 3) All dimensions in inches; Tolerances: x.xx +/-0.02 in [0.5 mm]. x.xxx +/-0.010 in [0.25 mm]. Unless otherwise stated.

ORQB-50Y05E/F PIN DEFINITIONS

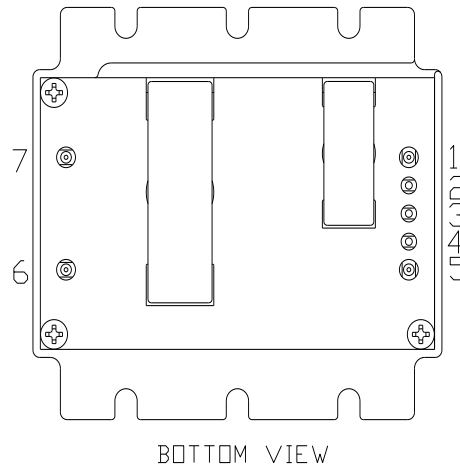

Figure 57. ORQB-50Y05E/F Pins

PIN	FUNCTION	PIN	FUNCTION
1	Vin (+)	5	Vin (-)
2	C_HOLD	6	Vout (-)
3	ON/OFF	7	Vout (+)
4	V_AUX(5V)		

ORQB-50Y05E/F RECOMMENDED PAD LAYOUT

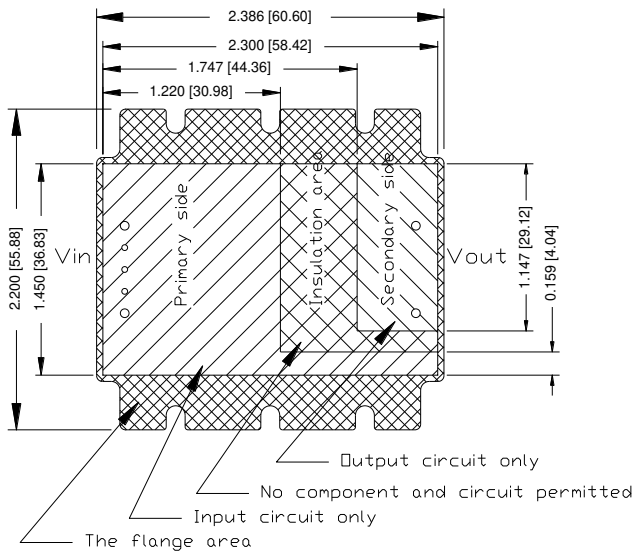

Figure 58. ORQB-50Y05E/F Recommended pad layout-1

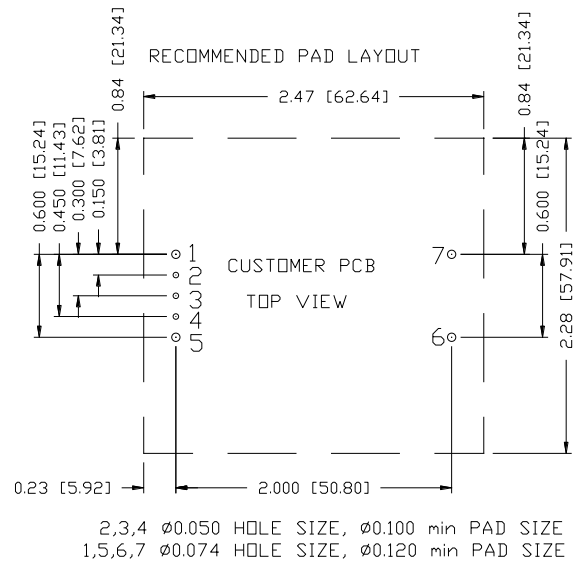

Figure 59. ORQB-50Y05E/F Recommended pad layout-2

18. REVISION HISTORY

DATE	REVISION	CHANGES DETAIL	APPROVAL
2017-09-18	AA	First release	S. Wang
2018-05-07	AB	Update Efficiency, TD, Specifications, Mechanical Dimensions and Key Features & Benefits Add Waveforms and Safety &EMC	S.Wang
2018-12-14	AC	Update input specifications, Transient Response, efficiency, TD, Mechanical dimensions, OCP and Safety &EMC	S.Wang
2019-03-13	AD	Update input specifications	S.Wang
2019-04-10	AE	Update general specifications	S.Wang
2019-05-14	AF	Update Transient Response and general specifications	S.Wang
2019-09-06	AG	Update output pre-bias ,star up time Turn-on Voltage Threshold and Turn-off Voltage Threshold	S.Wang
2019-10-24	AH	Add feature reinforced isolation	S.Wang
2020-01-15	AI	Add safety approved to IEC/EN 62368-1 and CSA/UL 62368-1. Update altitude to 5000m	F.Tao
2020-05-19	AJ	Add 0RQB-50Y050. Update absolute maximum ratings and input specifications	S. Wang
2020-07-09	AK	Add 0RQB-50Y05E/F and input L/C. Update startup & shutdown waveforms.	H.Yu
2020-11-25	AL	Update hold up capacitor.	H.Yu
2021-04-01	AM	Add object ID. Add weight and dimensions for flange version.	DW.Ren

For more information on these products consult: tech.support@psbel.com

NUCLEAR AND MEDICAL APPLICATIONS - Products are not designed or intended for use as critical components in life support systems, equipment used in hazardous environments, or nuclear control systems.

TECHNICAL REVISIONS - The appearance of products, including safety agency certifications pictured on labels, may change depending on the date manufactured. Specifications are subject to change without notice.



Asia-Pacific
+86 755 298 85888

Europe, Middle East
+353 61 225 977

North America
+1 408 785 5200