

PRODUCT NUMBER SEE SHEET 2

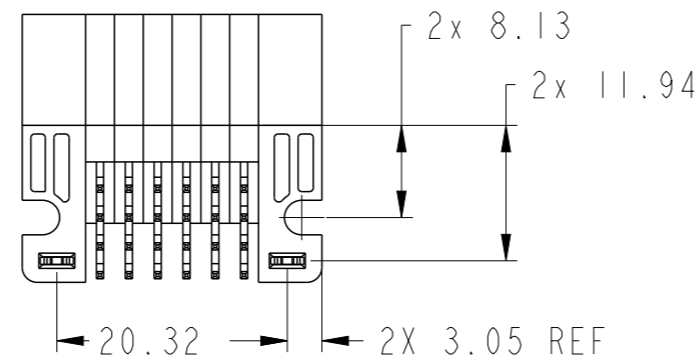

spec ref	*	dr	Rainbow Zhan	2015/06/30	projection	MM	size	A3	scale	3:2
tolerance std	ASME Y14.5	eng	Zhen-Hua Liu	2015/07/02			ecn no		-	
TOLERANCES UNLESS OTHERWISE SPECIFIED		chr	Fancy Zhang	2015/07/02			product family		PwrBlade+	rel level
surface	<input checked="" type="checkbox"/> linear <input type="checkbox"/> angular	appr	Pei-Ming Zheng	2015/07/02				title 24S RA STB HEADER	dwg no 10106262-0006003	rev A
ASME Y14.5	0.X ±0.5 0.XX ±0.25 0.XXX ±0.10	www.fci.com			cat. no.	Product - Customer Drw			sheet 1 of 3	
ASME Y14.5	angular	0°	±2°		PDS: Rev :A			STATUS:Released		Printed: Jul 02, 2015

PRODUCT NO.	ROWS	SIGNAL					
		E1	1	2	3	4	5
10106262-0006003LF	DCBA	U	U	U	U	U	U
		T	T	T	T	T	T
		S	S	S	S	S	S
		R	R	R	R	R	R

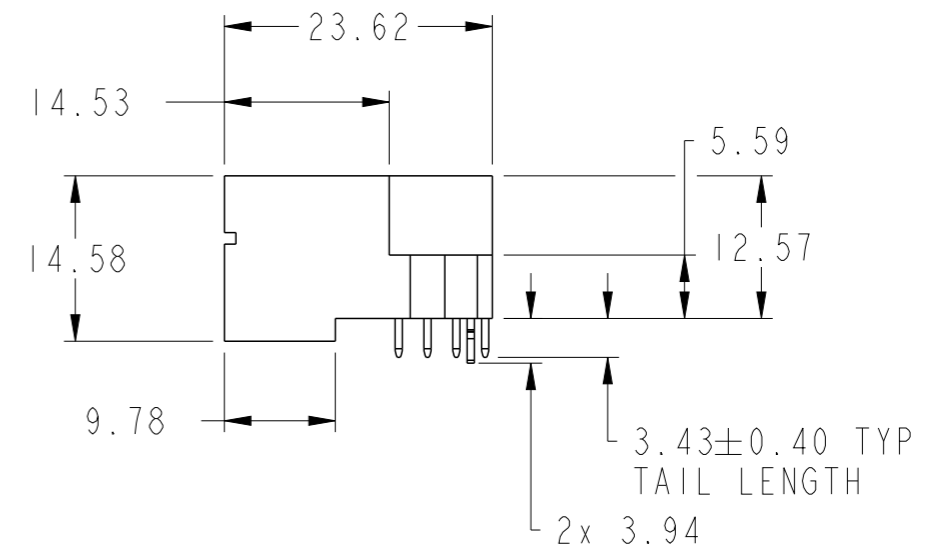
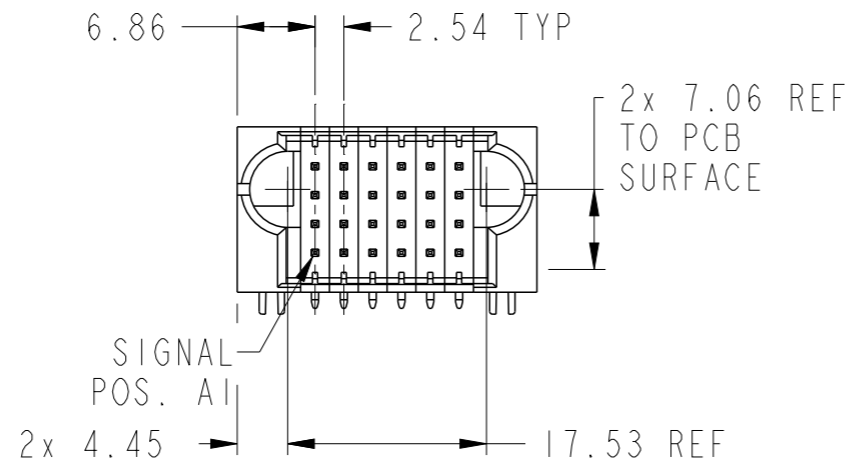
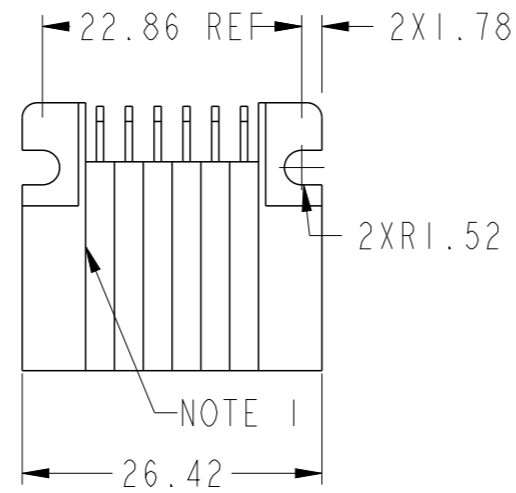
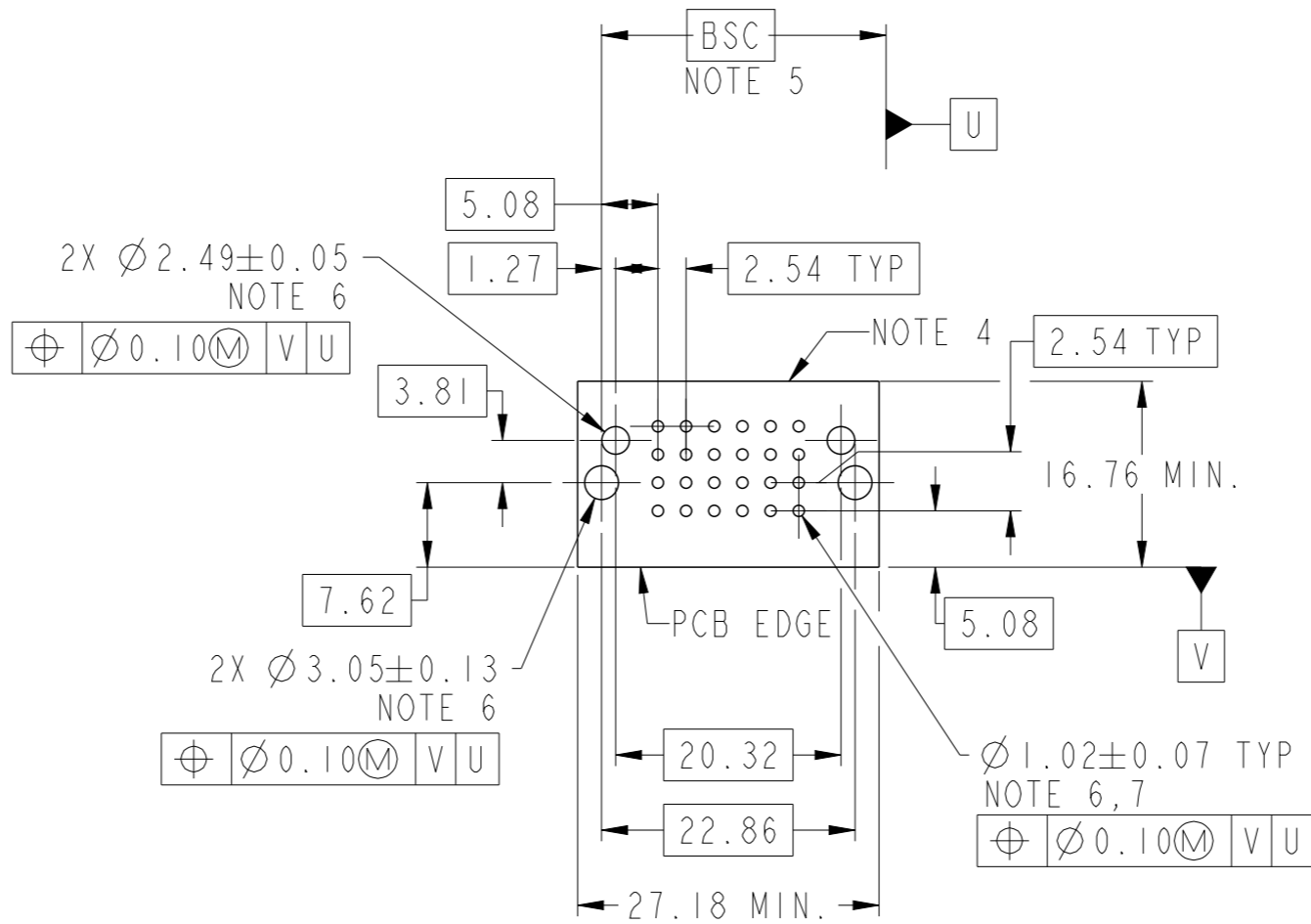

CODE	DESCRIPTION
HA	METAL HOLD DOWN
RL	MFBL SIGNAL CONTACT, ROW A (3.43)
S	STD SIGNAL CONTACT, ROW B (3.43)
T	STD SIGNAL CONTACT, ROW C (3.43)
U	STD SIGNAL CONTACT, ROW D (3.43)

dr	Rainbow Zhan	2015/06/30	projection 	size A3	scale 3:2
eng	Zhen-Hua Liu	2015/07/02			
chr	Fancy Zhang	2015/07/02			
appr	Pei-Ming Zheng	2015/07/02			
product family			PwrBlade+	ecn no	-
rel level			Released		
		title 24S RA STB HEADER	dwg no 10106262-0006003	rev A	
www.fci.com		cat. no.	Product - Customer Drw		sheet 2 of 3





Copyright FCI.

NOTES:

- 1) "FCI", PART NUMBER AND DATE CODE TO BE MARKED ON THIS SURFACE.
THE MARK CAN BE OMITTED IF THERE IS NOT ENOUGH SPACE ON THIS SURFACE.
- 2) MATERIALS:
-HOUSING - GLASS FILLED WITH HIGH TEMP THERMOPLASTIC, UL94V-0.
-SIGNAL CONTACT - COPPER ALLOY.
-POWER CONTACT - HIGH CONDUCTIVITY COPPER ALLOY.
- 3) PLATING SPECIFICATION : 10116351
- 4) DENOTES CONNECTOR KEEP OUT ZONE.
- 5) DATUM AND BASIC DIMENIONS WERE ESTABLISHED BY CUSTOMER.
- 6) ALL HOLE DIAMETERS ARE FINISHED HOLE SIZES.
- 7) 1.15±0.025MM DRILLED HOLE PLATED WITH 0.00762MM MIN Sn
OVER 0.0254-0.0762MM Cu PLATING TO ACHIEVE A 1.02±0.07MM HOLE.
- 8) PRODUCT SPECIFICATION : GS-12-658.
APPLICATION SPECIFICATION : GS-20-141.
PRODUCT PACKAGE SPECIFICATION : GS-14-1502.

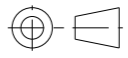
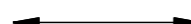

Copyright FCI.

dr	Rainbow Zhan	2015/06/30	projection 	MM 	size	A3	scale	3:2
eng	Zhen-Hua Liu	2015/07/02			ecn no	-		
chr	Fancy Zhang	2015/07/02			rel level	Released		
appr	Pei-Ming Zheng	2015/07/02	product family	PwrBlade+				
		title 24S RA STB HEADER	dwg no 10106262-0006003	rev A				
www.fci.com		cat. no.	Product - Customer Drw		sheet 3 of 3			