

PM75CL1A060

FLAT-BASE TYPE
INSULATED PACKAGE

PM75CL1A060



FEATURE

Inverter + Drive & Protection IC

- a) Adopting new 5th generation Full-Gate CSTBT™ chip
- b) The over-temperature protection which detects the chip surface temperature of CSTBT™ is adopted.
- c) Error output signal is possible from all each protection upper and lower arm of IPM.
- d) Compatible L-series package.

- 3φ 75A, 600V Current-sense and temperature sense IGBT type inverter
- Monolithic gate drive & protection logic
- Detection, protection & status indication circuits for, short-circuit, over-temperature & under-voltage (P-Fo available from upper arm devices)
- UL Recognized

APPLICATION

General purpose inverter, servo drives and other motor controls

PACKAGE OUTLINES

Dimensions in mm

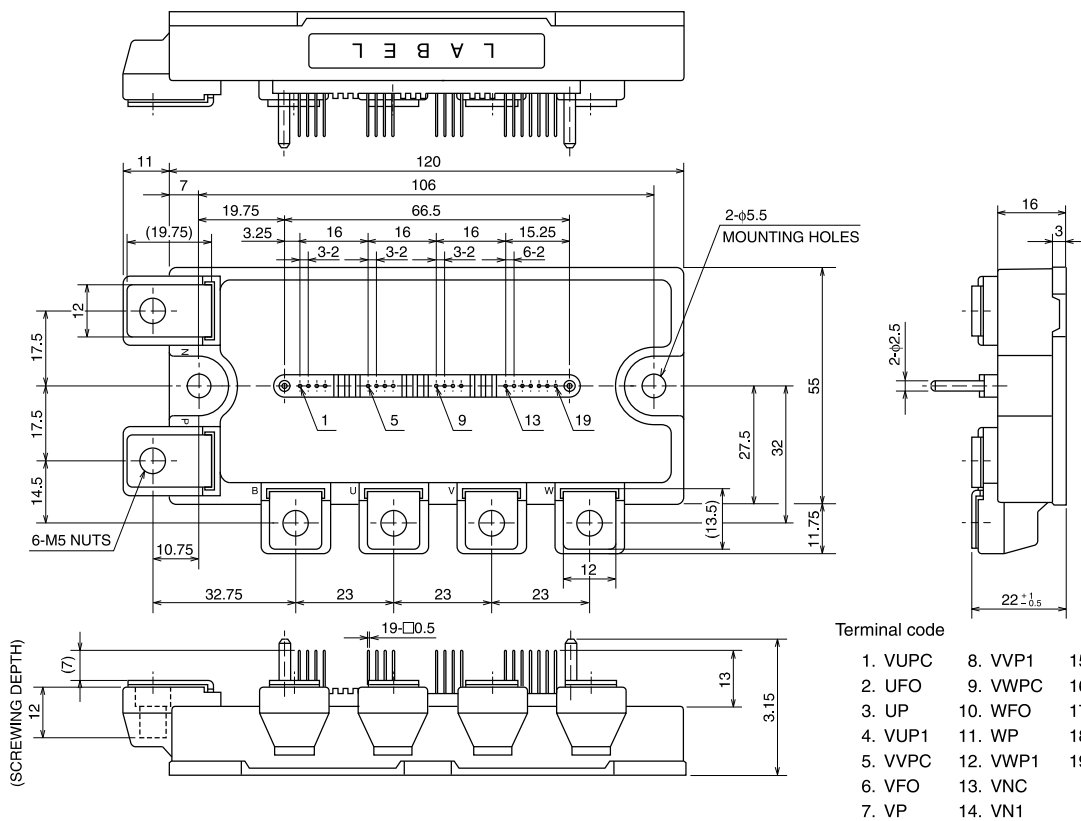

PM75CL1A060

FLAT-BASE TYPE
INSULATED PACKAGE

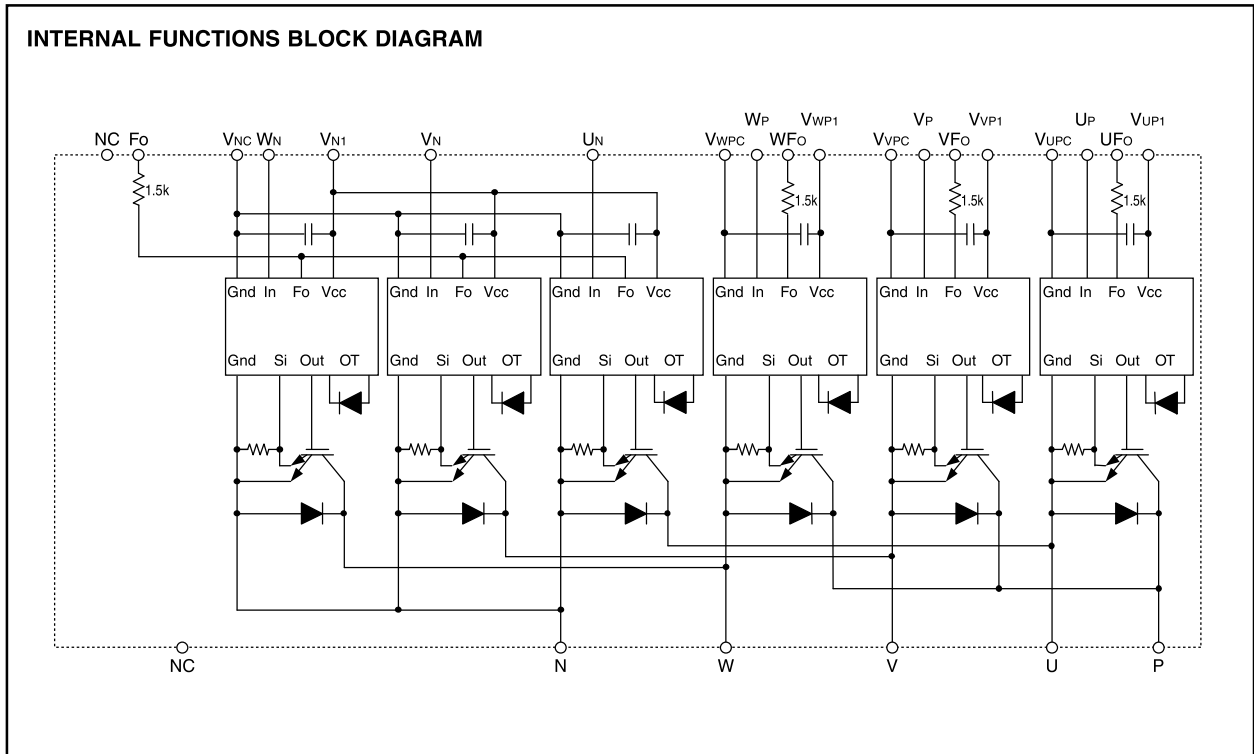

MAXIMUM RATINGS ($T_j = 25^\circ\text{C}$, unless otherwise noted)

INVERTER PART

| Symbol | Parameter | Condition | Ratings | Unit |
|--------------|---------------------------|---|------------|------------------|
| V_{CES} | Collector-Emitter Voltage | $V_D = 15\text{V}$, $V_{CIN} = 15\text{V}$ | 600 | V |
| $\pm I_C$ | Collector Current | $T_C = 25^\circ\text{C}$ (Note-1) | 75 | A |
| $\pm I_{CP}$ | Collector Current (Peak) | $T_C = 25^\circ\text{C}$ | 150 | A |
| P_C | Collector Dissipation | $T_C = 25^\circ\text{C}$ (Note-1) | 337 | W |
| T_j | Junction Temperature | | -20 ~ +150 | $^\circ\text{C}$ |

*: T_c measurement point is just under the chip.

CONTROL PART

| Symbol | Parameter | Condition | Ratings | Unit |
|-----------|-----------------------------|---|---------|------|
| V_D | Supply Voltage | Applied between : $V_{UP1}-V_{UPC}$, $V_{VP1}-V_{VPC}$ $V_{WP1}-V_{WPC}$, $V_{N1}-V_{NC}$ | 20 | V |
| V_{CIN} | Input Voltage | Applied between : U_P-V_{UPC} , V_P-V_{VPC} , W_P-V_{WPC} $U_N \cdot V_N \cdot W_N-V_{NC}$ | 20 | V |
| V_{FO} | Fault Output Supply Voltage | Applied between : $U_{FO}-V_{UPC}$, $V_{FO}-V_{VPC}$, $W_{FO}-V_{WPC}$ F_O-V_{NC} | 20 | V |
| I_{FO} | Fault Output Current | Sink current at U_{FO} , V_{FO} , W_{FO} , F_O terminals | 20 | mA |

PM75CL1A060

FLAT-BASE TYPE
INSULATED PACKAGE

TOTAL SYSTEM

| Symbol | Parameter | Condition | Ratings | Unit |
|------------------|--------------------------------|---|------------|------------------|
| VCC(PROT) | Supply Voltage Protected by SC | V _D = 13.5 ~ 16.5V Inverter Part, T _j = +125°C Start | 400 | V |
| VCC(surge) | Supply Voltage (Surge) | Applied between : P-N, Surge value | 500 | V |
| T _{stg} | Storage Temperature | | -40 ~ +125 | °C |
| Viso | Isolation Voltage | 60Hz, Sinusoidal, Charged part to Base, AC 1 min. | 2500 | V _{rms} |

THERMAL RESISTANCES

| Symbol | Parameter | Condition | Limits | | | Unit |
|-----------------------|--------------------------------------|--|--------|------|-------|------|
| | | | Min. | Typ. | Max. | |
| R _{th(j-c)Q} | Junction to case Thermal Resistances | Inverter IGBT part (per 1 element) (Note-1) | — | — | 0.37 | °C/W |
| R _{th(j-c)F} | | Inverter FWDi part (per 1 element) (Note-1) | — | — | 0.63 | |
| R _{th(c-f)} | Contact Thermal Resistance | Case to fin, (per 1 module) Thermal grease applied (Note-1) | — | — | 0.038 | |

* If you use this value, R_{th(f-a)} should be measured just under the chips.

(Note-1) T_c (under the chip) measurement point is below.

(unit : mm)

| axis \ arm | UP | | VP | | WP | | UN | | VN | | WN | |
|------------|------|------|------|------|------|------|------|------|------|------|------|------|
| | IGBT | FWDi | IGBT | FWDi | IGBT | FWDi | IGBT | FWDi | IGBT | FWDi | IGBT | FWDi |
| X | 27.9 | 27.9 | 66.2 | 66.2 | 85.8 | 85.8 | 37.4 | 37.4 | 56.1 | 56.1 | 74.7 | 74.7 |
| Y | -6.2 | 0.2 | -6.2 | 0.2 | -6.2 | 0.2 | 5.4 | -0.8 | 5.4 | -0.8 | 5.4 | -0.8 |

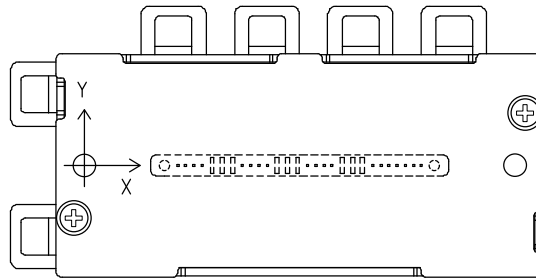

Bottom view

ELECTRICAL CHARACTERISTICS (T_j = 25°C, unless otherwise noted)

INVERTER PART

| Symbol | Parameter | Condition | Limits | | | Unit | |
|----------------------|--------------------------------------|--|------------------------|------|------|------|----|
| | | | Min. | Typ. | Max. | | |
| V _{CE(sat)} | Collector-Emitter Saturation Voltage | V _D = 15V, I _C = 75A V _{CIN} = 0V, Pulsed (Fig. 1) | T _j = 25°C | — | 1.75 | 2.35 | V |
| | | | T _j = 125°C | — | 1.75 | 2.35 | |
| V _{EC} | FWDi Forward Voltage | -I _C = 75A, V _D = 15V, V _{CIN} = 15V (Fig. 2) | — | 1.7 | 2.8 | V | |
| t _{on} | Switching Time | V _D = 15V, V _{CIN} = 0V↔15V V _{CC} = 300V, I _C = 75A T _j = 125°C Inductive Load (Fig. 3,4) | 0.3 | 0.8 | 2.0 | μs | |
| t _{tr} | | | — | 0.4 | 0.8 | | |
| t _{c(on)} | | | — | 0.4 | 1.0 | | |
| t _{off} | | | — | 1.0 | 2.3 | | |
| t _{c(off)} | | | — | 0.3 | 1.0 | | |
| I _{CES} | Collector-Emitter Cutoff Current | V _{CE} = V _{CES} , V _D = 15V (Fig. 5) | T _j = 25°C | — | — | 1 | mA |
| | | | T _j = 125°C | — | — | 10 | |

PM75CL1A060

FLAT-BASE TYPE
INSULATED PACKAGE

CONTROL PART

| Symbol | Parameter | Condition | Limits | | | Unit | |
|----------------------|---|---|----------------------------------|------|------|------|----|
| | | | Min. | Typ. | Max. | | |
| I _D | Circuit Current | V _D = 15V, V _{CIN} = 15V | V _{N1} -V _{N2} | — | 6 | 12 | mA |
| | | | V _{P1} -V _{P2} | — | 2 | 4 | |
| V _{th(ON)} | Input ON Threshold Voltage | Applied between : UP-VUPC, VP-VVPC, WP-VWPC UN • VN • WN-VNC | 1.2 | 1.5 | 1.8 | V | |
| V _{th(OFF)} | Input OFF Threshold Voltage | | 1.7 | 2.0 | 2.3 | | |
| SC | Short Circuit Trip Level | -20 ≤ T _j ≤ 125°C, V _D = 15V (Fig. 3,6) | 150 | — | — | A | |
| t _{off(SC)} | Short Circuit Current Delay Time | V _D = 15V (Fig. 3,6) | — | 0.2 | — | μs | |
| OT | Over Temperature Protection | Detect Temperature of IGBT chip | Trip level | 135 | — | — | °C |
| OT(hys) | | | Hysteresis | — | 20 | — | |
| UV | Supply Circuit Under-Voltage Protection | -20 ≤ T _j ≤ 125°C | Trip level | 11.5 | 12.0 | 12.5 | V |
| UV _r | | | Reset level | — | 12.5 | — | |
| I _{FO(H)} | Fault Output Current | V _D = 15V, V _{CIN} = 15V (Note-2) | — | — | 0.01 | mA | |
| I _{FO(L)} | | | — | 10 | 15 | | |
| t _{FO} | Minimum Fault Output Pulse Width | V _D = 15V (Note-2) | 1.0 | 1.8 | — | ms | |

(Note-2) Fault output is given only when the internal SC, OT & UV protections schemes of either upper or lower arm device operate to protect it.

MECHANICAL RATINGS AND CHARACTERISTICS

| Symbol | Parameter | Condition | Limits | | | Unit |
|--------|-----------------|-------------------------------|--------|------|------|-------|
| | | | Min. | Typ. | Max. | |
| — | Mounting torque | Mounting part screw : M5 | 2.5 | 3.0 | 3.5 | N • m |
| | | Main terminal part screw : M5 | 2.5 | 3.0 | 3.5 | |
| — | Weight | — | — | 380 | — | g |

RECOMMENDED CONDITIONS FOR USE

| Symbol | Parameter | Condition | Recommended value | Unit |
|-----------------------|---------------------------------|---|-------------------|------|
| V _{CC} | Supply Voltage | Applied across P-N terminals | ≤ 400 | V |
| V _D | Control Supply Voltage | Applied between : V _{UP1} -V _{UPC} , V _{VP1} -V _{VP2} V _{WP1} -V _{WP2} , V _{N1} -V _{N2} (Note-3) | 15.0 ± 1.5 | V |
| V _{CIN(ON)} | Input ON Voltage | Applied between : UP-VUPC, VP-VVPC, WP-VWPC UN • VN • WN-VNC | ≤ 0.8 | V |
| V _{CIN(OFF)} | Input OFF Voltage | | ≥ 9.0 | |
| f _{PWM} | PWM Input Frequency | Using Application Circuit of Fig. 8 | ≤ 20 | kHz |
| t _{dead} | Arm Shoot-through Blocking Time | For IPM's each input signals (Fig. 7) | ≥ 2.0 | μs |

(Note-3) With ripple satisfying the following conditions: dv/dt swing ≤ ±5V/μs, Variation ≤ 2V peak to peak

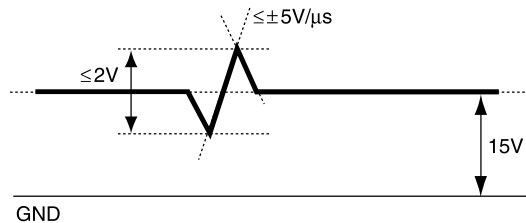

PM75CL1A060

FLAT-BASE TYPE
INSULATED PACKAGE

PRECAUTIONS FOR TESTING

- Before applying any control supply voltage (V_D), the input terminals should be pulled up by resistors, etc. to their corresponding supply voltage and each input signal should be kept off state.
After this, the specified ON and OFF level setting for each input signal should be done.
- When performing "SC" tests, the turn-off surge voltage spike at the corresponding protection operation should not be allowed to rise above V_{CES} rating of the device.
(These test should not be done by using a curve tracer or its equivalent.)

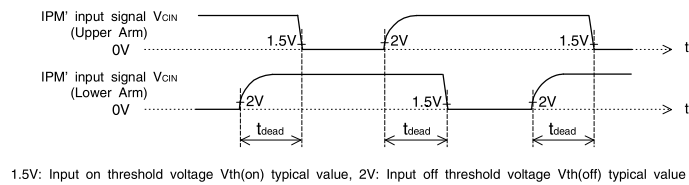
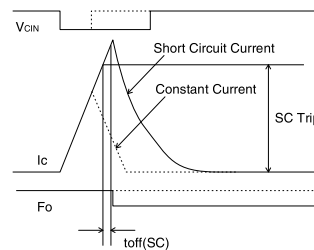
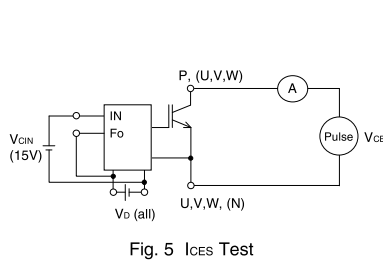
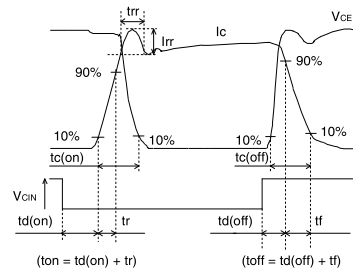
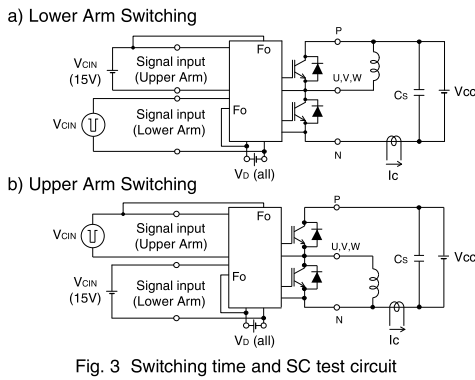
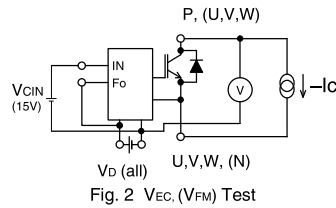
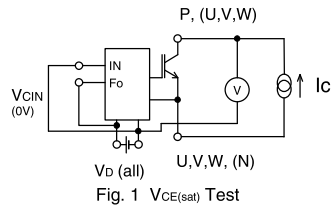

PM75CL1A060

FLAT-BASE TYPE
INSULATED PACKAGE

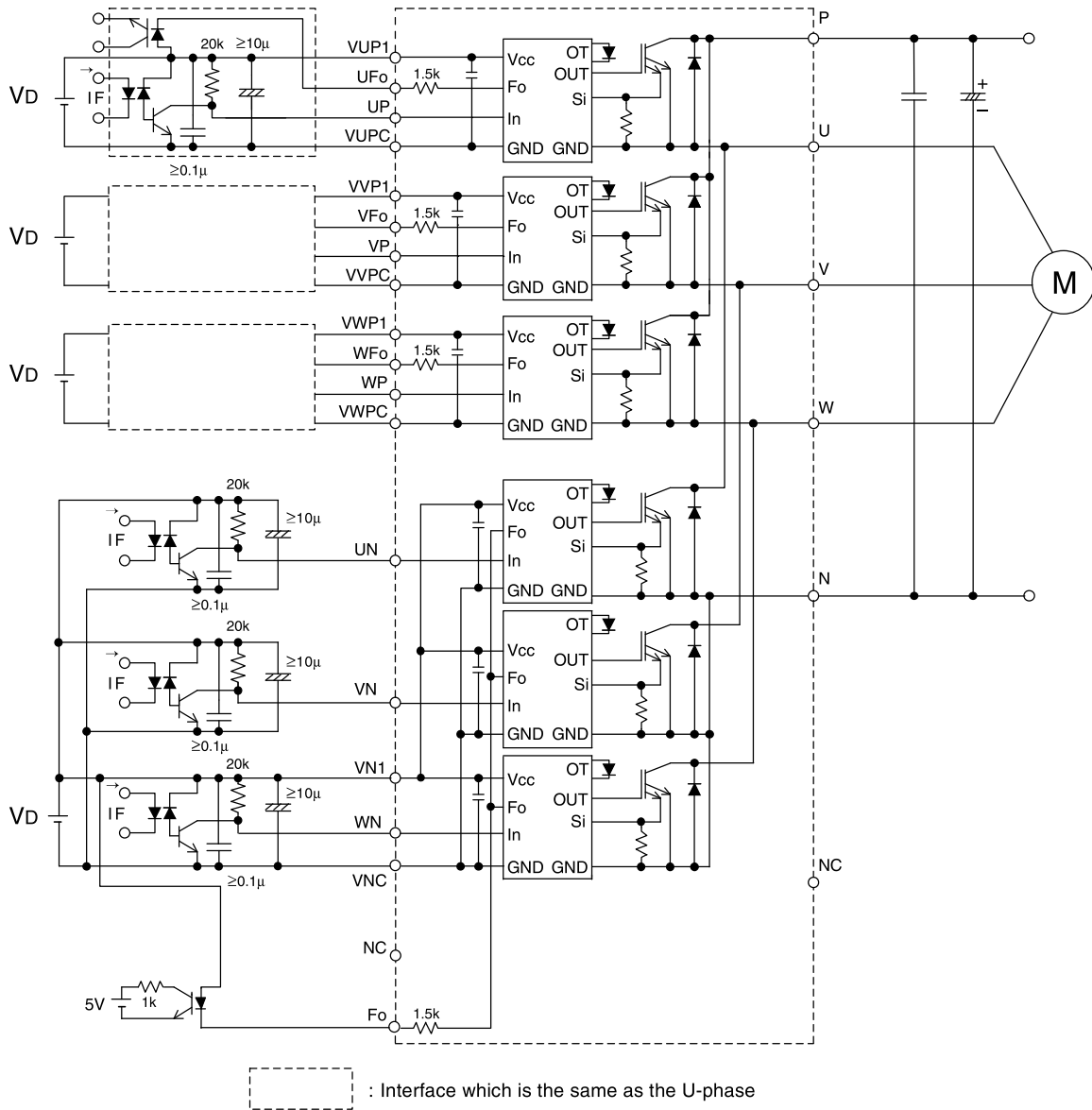

Fig. 8 Application Example Circuit

NOTES FOR STABLE AND SAFE OPERATION ;

- Design the PCB pattern to minimize wiring length between opto-coupler and IPM's input terminal, and also to minimize the stray capacity between the input and output wirings of opto-coupler.
- Connect low impedance capacitor between the Vcc and GND terminal of each fast switching opto-coupler.
- Fast switching opto-couplers: $t_{PLH}, t_{PHL} \leq 0.8\mu s$, Use High CMR type.
- Slow switching opto-coupler: CTR > 100%
- Use 4 isolated control power supplies (VD). Also, care should be taken to minimize the instantaneous voltage charge of the power supply.
- Make inductance of DC bus line as small as possible, and minimize surge voltage using snubber capacitor between P and N terminal.
- Use line noise filter capacitor (ex. 4.7nF) between each input AC line and ground to reject common-mode noise from AC line and improve noise immunity of the system.

PM75CL1A060

FLAT-BASE TYPE
INSULATED PACKAGE

PERFORMANCE CURVES

OUTPUT CHARACTERISTICS (TYPICAL)

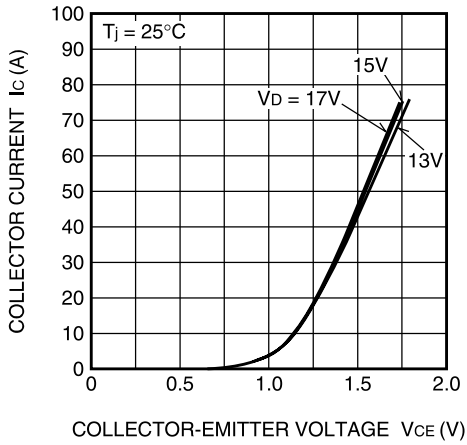

COLLECTOR-EMITTER SATURATION VOLTAGE (VS. I_c) CHARACTERISTICS (TYPICAL)

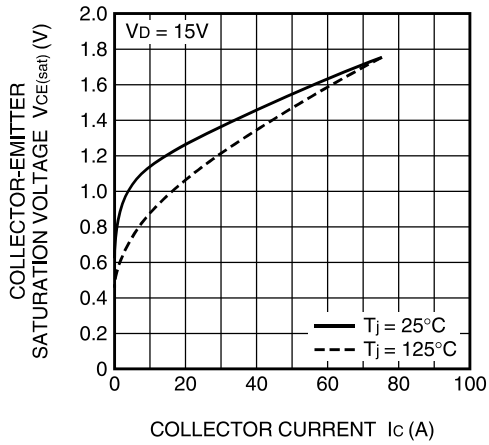

COLLECTOR-EMITTER SATURATION VOLTAGE (VS. V_D) CHARACTERISTICS (TYPICAL)

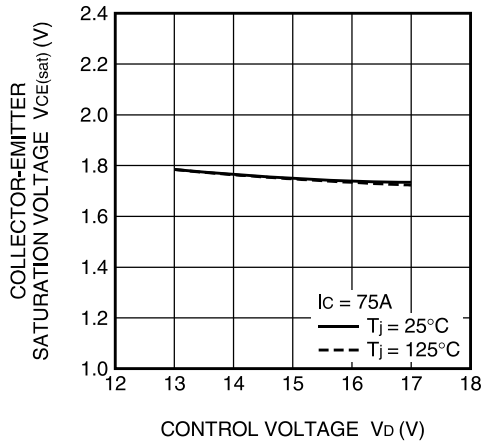

DIODE FORWARD CHARACTERISTICS (TYPICAL)

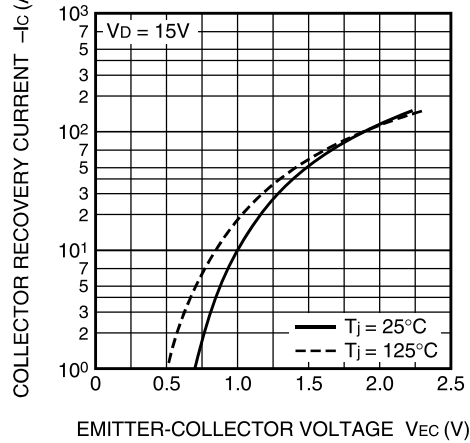

SWITCHING TIME (t_{on} , t_{off}) CHARACTERISTICS (TYPICAL)

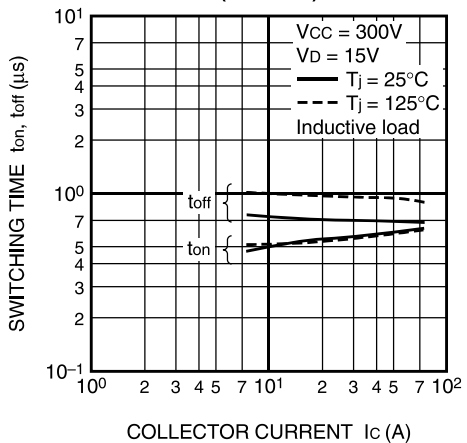

SWITCHING TIME ($t_{c(on)}$, $t_{c(off)}$) CHARACTERISTICS (TYPICAL)

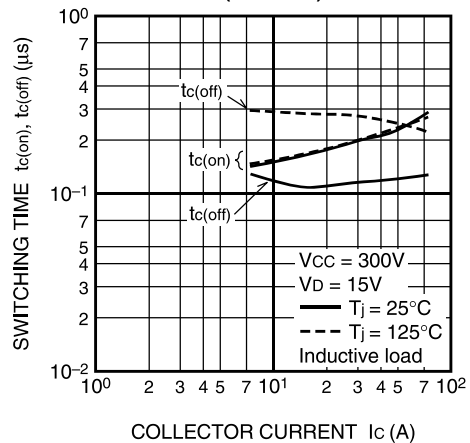

PM75CL1A060

FLAT-BASE TYPE
INSULATED PACKAGE

SWITCHING LOSS CHARACTERISTICS (TYPICAL)

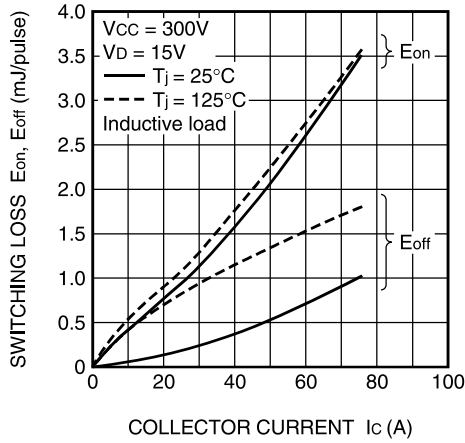

DIODE REVERSE RECOVERY CHARACTERISTICS (TYPICAL)

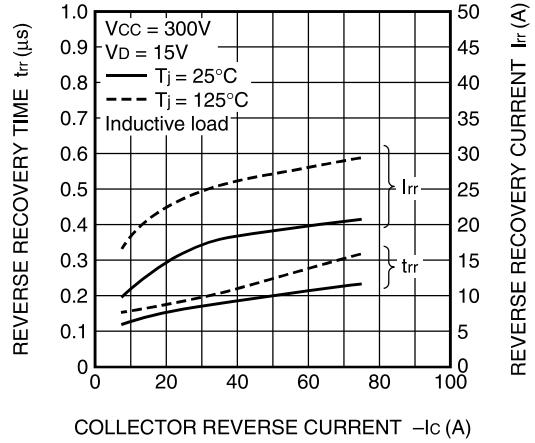

SWITCHING RECOVERY LOSS CHARACTERISTICS (TYPICAL)

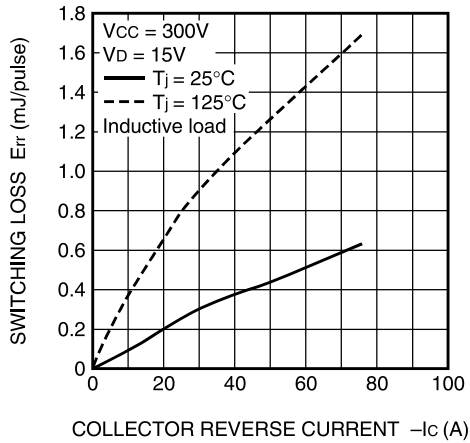

I_D VS. f_c CHARACTERISTICS (TYPICAL)

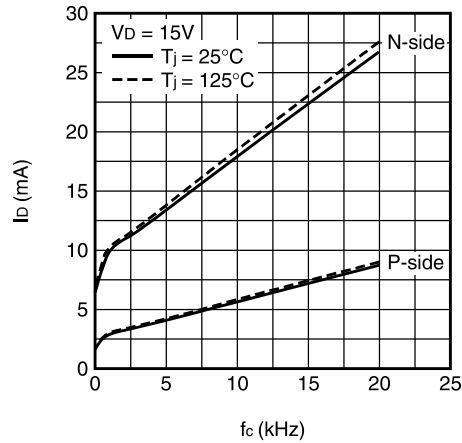

UV TRIP LEVEL VS. T_j CHARACTERISTICS (TYPICAL)

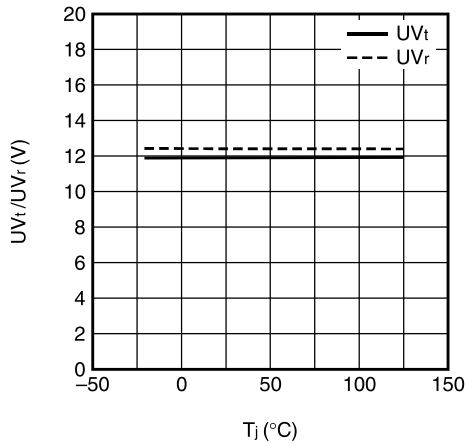

SC TRIP LEVEL VS. T_j CHARACTERISTICS (TYPICAL)

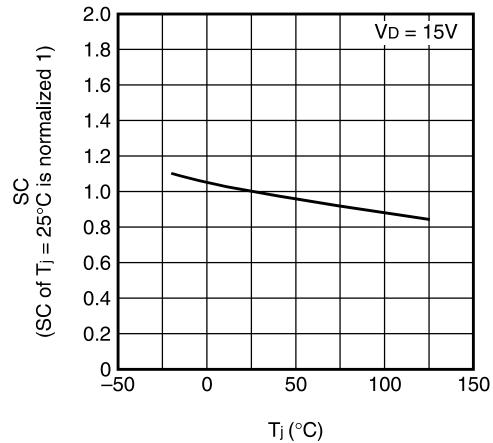

PM75CL1A060

FLAT-BASE TYPE
INSULATED PACKAGE

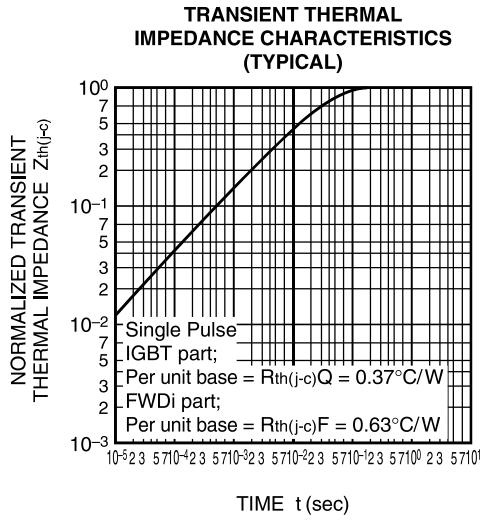

Important Notice

The information contained in this datasheet shall in no event be regarded as a guarantee of conditions or characteristics. This product has to be used within its specified maximum ratings, and is subject to customer's compliance with any applicable legal requirement, norms and standards.

Except as otherwise explicitly approved by Mitsubishi Electric Corporation in a written document signed by authorized representatives of Mitsubishi Electric Corporation, our products may not be used in any applications where a failure of the product or any consequences of the use thereof can reasonably be expected to result in personal injury.

In usage of power semiconductor, there is always the possibility that trouble may occur with them by the reliability lifetime such as Power Cycle, Thermal Cycle or others, or when used under special circumstances (e.g. condensation, high humidity, dusty, salty, highlands, environment with lots of organic matter / corrosive gas / explosive gas, or situations which terminals of semiconductor products receive strong mechanical stress). Therefore, please pay sufficient attention to such circumstances. Further, depending on the technical requirements, our semiconductor products may contain environmental regulation substances, etc. If there is necessity of detailed confirmation, please contact our nearest sales branch or distributor.

The contents or data contained in this datasheet are exclusively intended for technically trained staff. Customer's technical departments should take responsibility to evaluate the suitability of Mitsubishi Electric Corporation product for the intended application and the completeness of the product data with respect to such application. In the customer's research and development, please evaluate it not only with a single semiconductor product but also in the entire system, and judge whether it's applicable. As required, pay close attention to the safety design by installing appropriate fuse or circuit breaker between a power supply and semiconductor products to prevent secondary damage. Please also pay attention to the application note and the related technical information.

Keep safety first in your circuit designs!

Mitsubishi Electric Corporation puts the maximum effort into making semiconductor products better and more reliable, but there is always the possibility that trouble may occur with them. Trouble with semiconductors may lead to personal injury, fire or property damage. Remember to give due consideration to safety when making your circuit designs, with appropriate measures such as (i) placement of substitutive, auxiliary circuits, (ii) use of non-flammable material or (iii) prevention against any malfunction or mishap.

Notes regarding these materials

- These materials are intended as a reference to assist our customers in the selection of the Mitsubishi Electric Semiconductor product best suited to the customer's application; they do not convey any license under any intellectual property rights, or any other rights, belonging to Mitsubishi Electric Corporation or a third party.
- Mitsubishi Electric Corporation assumes no responsibility for any damage, or infringement of any third-party's rights, originating in the use of any product data, diagrams, charts, programs, algorithms, or circuit application examples contained in these materials.
- All information contained in these materials, including product data, diagrams, charts, programs and algorithms represents information on products at the time of publication of these materials, and are subject to change by Mitsubishi Electric Corporation without notice due to product improvements or other reasons. It is therefore recommended that customers contact Mitsubishi Electric Corporation or an authorized Mitsubishi Electric Semiconductor product distributor for the latest product information before purchasing a product listed herein.
The information described here may contain technical inaccuracies or typographical errors. Mitsubishi Electric Corporation assumes no responsibility for any damage, liability, or other loss rising from these inaccuracies or errors.
Please also pay attention to information published by Mitsubishi Electric Corporation by various means, including the Mitsubishi Electric Semiconductor home page (<http://www.MitsubishiElectric.com/semiconductors/>).
- When using any or all of the information contained in these materials, including product data, diagrams, charts, programs, and algorithms, please be sure to evaluate all information as a total system before making a final decision on the applicability of the information and products. Mitsubishi Electric Corporation assumes no responsibility for any damage, liability or other loss resulting from the information contained herein.
- Mitsubishi Electric Corporation semiconductors are not designed or manufactured for use in a device or system that is used under circumstances in which human life is potentially at stake. Please contact Mitsubishi Electric Corporation or an authorized Mitsubishi Electric Semiconductor product distributor when considering the use of a product contained herein for any specific purposes, such as apparatus or systems for transportation, vehicular, medical, aerospace, nuclear, or undersea repeater use.
- The prior written approval of Mitsubishi Electric Corporation is necessary to reprint or reproduce in whole or in part these materials.
- If these products or technologies are subject to the Japanese export control restrictions, they must be exported under a license from the Japanese government and cannot be imported into a country other than the approved destination.
Any diversion or re-export contrary to the export control laws and regulations of Japan and/or the country of destination is prohibited.
- Please contact Mitsubishi Electric Corporation or an authorized Mitsubishi Electric Semiconductor product distributor for further details on these materials or the products contained therein.

Generally the listed company name and the brand name are the trademarks or registered trademarks of the respective companies.