

MATERIALS & SPECIFICATIONS

PART NO.	A22049-001	REV	ECO	DATE	APP
		B	96708	05-06-10	TLM

INSULATOR:
LIQUID CRYSTAL POLYMER (LCP) PER ASTM D5138.

CONTACT:
COPPER ALLOY PER MIL-DTL-83513. GOLD PLATED PER
ASTM B488, (HARD GOLD) TYPE II CODE C CLASS 1.27.

TERMINATION:
SOLDER COATED PER J-STD-006.

LATCH BOX:
BERYLLIUM COPPER PER ASTM B194 NICKEL PLATE PER
AMS-C-26074

CURRENT CAPACITY:
3 AMP MAX.

CONTACT RESISTANCE:
26 MILLIOHMS (65mV) MAX @ 2.5 AMPS.

PERFORMANCE:
PRODUCT FAMILY TESTED TO AND PASSED THE PERFORMANCE
SPECIFICATIONS OF TABLE VII OF MIL-DTL-83513.

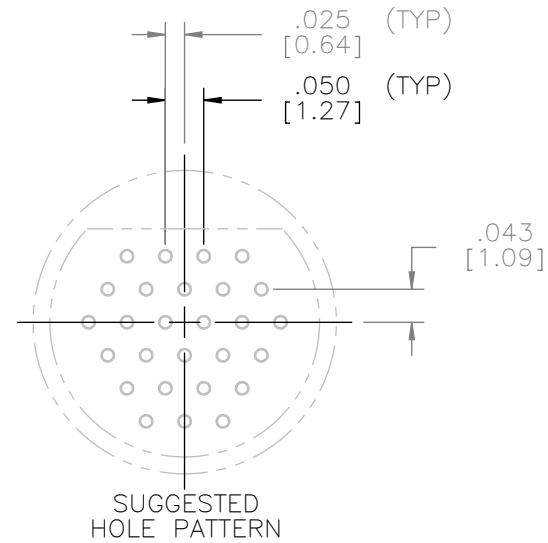

ACTUAL SIZE

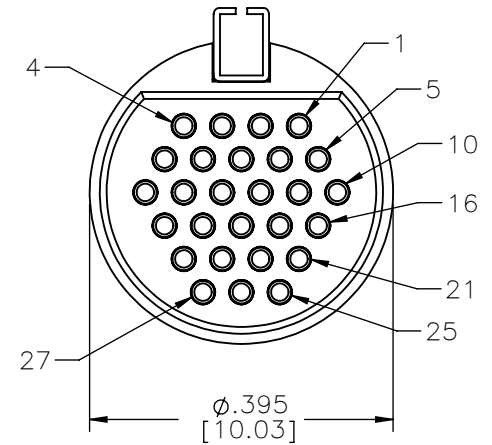
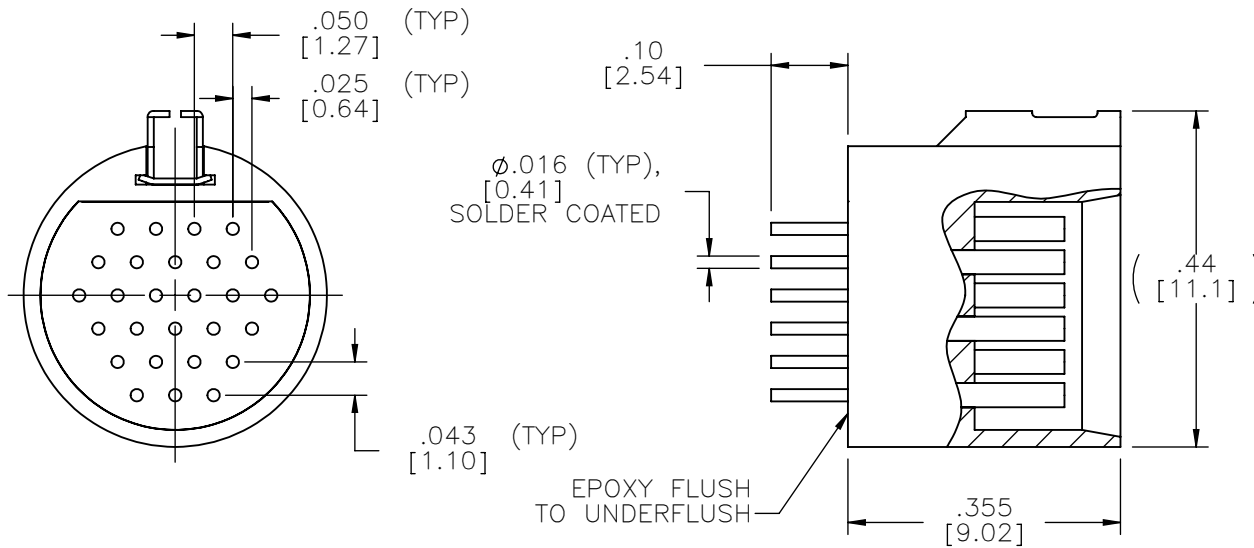

REF: OMNETICS

MCS	THIRD ANGLE
	-TOLERANCES-
SLDW	UNLESS OTHERWISE NOTED
	DIMENSIONS IN INCHES
	2 PL DEC ± .01
	3 PL DEC ± .005
	4 PL DEC ± .0005
	ANGLES ± 1°

THIS DRAWING CONTAINS CONFIDENTIAL AND PROPRIETARY INFORMATION WHICH IS THE PROPERTY OF OMNETICS CONNECTOR CORP. THIS DOCUMENT MAY NOT, IN WHOLE OR IN PART, BE DUPLICATED, OR DISCLOSED FOR ANY PURPOSE, WITHOUT WRITTEN PERMISSION FROM OMNETICS CONNECTOR CORP.	
DFTM. TLM	DATE 05-09-08
CHK'D.	DATE
APP'D.	DATE
TITLE: (27) SOCKET FEMALE MICRO CIRCULAR CONNECTOR W/ LATCH	

OMNETICS
CONNECTOR CORPORATION
7260 COMMERCE CIRCLE EAST
MINNEAPOLIS, MN 55432
WWW.OMNETICS.COM

CAGE CODE 61873
DWG NO. A22049-001
SHEET 1 OF 1
SCALE: 4:1
REV B