

Clarity Series™ Translucent & White DAS Antenna Family Ultra-Thin, Ceiling-Mount Omni Antenna

Featuring PIMinator® Low PIM Performance



DASUTCCxxx

Installed: PROFILE VIEW and DIRECT VIEW FROM BELOW

Industry leading -155 dBc PIM compliant in-building Ultra-Thin ceiling mount DAS omni antenna family including six different antenna products and one Energy Directive Reflector. The Pulse Electronics PIMinator® line of DAS in-building low PIM omni antenna meets the most demanding PIM requirements for 2G, 3G, 4G (LTE) and WiFi bands. DASUTCC / DASUTWC product family includes a 500mm pigtail with N, Mini-DIN and 4.3-10 female connector.

Features

- Ultra-Thin
- Translucent (Clear) and White
- Industry leading -155 dBc at 2 x 20 watts (2 x 43dBm) PIM rating
- Covers cellular bands and WiFi from 608 through 2700 MHz
- Available with N, Mini-DIN and 4.3-10 female connector
- RoHS Compliant
- Patent Pending design

Applications

- Ultra-Thin structure of products allow installation in places where Aesthetics is important
- Clear (Translucent) structure of antenna make this product nearly-invisible
- In-building DAS systems requiring best PIM



DASUTCCxxx
TRANSLUCENT



DASUTWCxxx
WHITE

Antennas and accessory products covered in this documents are as follows:

Pulse P/N : TRANSLUCENT	Pulse P/N: WHITE	Connector Type	Reflector
DASUTCCR500NF	DASUTWCR500NF	N Female	Included
DASUTCCR500MD	DASUTWCR500MD	4.1-9.5 Mini-DIN Female	Included
DASUTCCR5004310	DASUTWCR5004310	4.3-10 DIN Female	Included
DASUTCC500NF	DASUTWC500NF	N Female	Not Included
DASUTCC500MD	DASUTWC500MD	4.1-9.5 Mini-DIN Female	Not Included
DASUTCC5004310	DASUTWC5004310	4.3-10 DIN Female	Not Included

Accessory Part Number	Description
DASUTCCACC1	Reflector only (not antenna)
DASACABSORBER	PIM-Blocker Absorber
DASACHOLDER	Above-Ceiling Antenna Holder
DASCLINSERT	Clarity Installation Adapter



REFLECTOR

Confidential and Proprietary — Pulse Electronics — All Rights Reserved — 2016.

This document contains confidential and proprietary information of Pulse Electronics, Inc. (Pulse) and is protected by copyright, trade secret and other state and federal laws. Its receipt or possession does not convey any rights to reproduce, disclose its contents, or to manufacture, use or sell anything it may describe. Reproduction, disclosure or use without specific written authorization of Pulse is strictly forbidden.

San Diego, California
858 674 8100

Vancouver, Washington
360 944 7551

Europe
49 173 659 8521

China
86 512 69206053

Clarity Series™

Translucent & White DAS Antenna Family Ultra-Thin, Ceiling-Mount Omni Antenna

Featuring PIMinator® Low PIM Performance

Electrical Specifications (Both Clear & White configuration)

Frequency [MHz]		608-960/1695-2200/ 2300-2700	
Nominal Impedance [Ω]		50	
VSWR	608-960 MHz	<2:1	
	1695-2200 MHz	<2:1	
	2300-2700 MHz	<2:1	
		Without Reflector	With Reflector
Gain	608-960 MHz [dBi typ]	4	7
	1695-2200 MHz [dBi typ]	6	7
	2300-2700 MHz [dBi typ]	6	5
Radiation Pattern	HPBW Horizontal Plane at 45° [°]	360	
	HPBW Vertical Plane (608-960) [° typ]	100	90
	HPBW Vertical Plane (1695-2700) [° typ]	130	25
Polarization		Vertical	
Power Rating [W]		40	
PIM at 2x20 Watts [dBc]		-155	
Connector		(NF), (4.1-9.5 Mini DIN F), (4.3-10 DIN F)	
Cable Type		Plenum Rated, CM-Rated, NFPA262 compliant	

Mechanical Specifications

Radome Material	UV Protected, UL94 V-0
Weight [oz/g]	1.65 / 750
Dimensions [Inches/mm]	9.41 / 239 diameter
Height [Inches/mm]	Full height 6.78 / 172 Extension from ceiling only 0.33 / 8.4

Environmental Specifications

Operating Temperature [°C]	-40 to +70
----------------------------	------------

San Diego, California
858 674 8100

Vancouver, Washington
360 944 7551

Europe
49 173 659 8521

China
86 512 69206053

Clarity Series™

Translucent & White DAS Antenna Family Ultra-Thin, Ceiling-Mount Omni Antenna

Featuring PIMinator® Low PIM Performance

Mechanical Drawings without Reflector

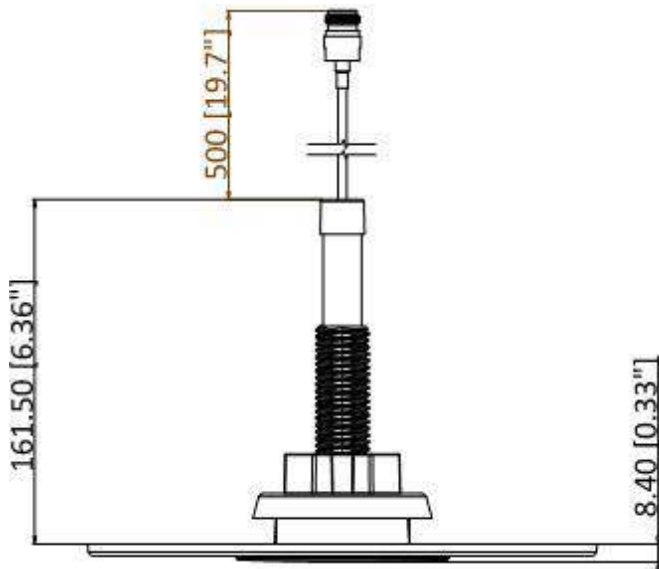

Mechanical Drawings with Reflector

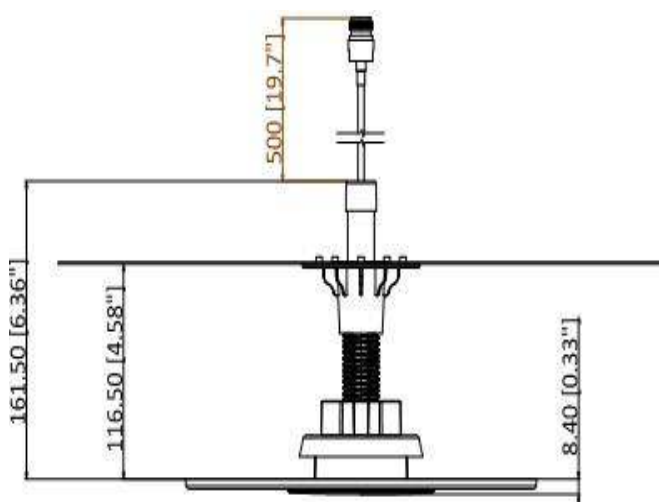

San Diego, California
858 674 8100

Vancouver, Washington
360 944 7551

Europe
49 173 659 8521

China
86 512 69206053

Clarity Series™

Translucent & White DAS Antenna Family
Ultra-Thin, Ceiling-Mount Omni Antenna

Featuring PIMinator® Low PIM Performance

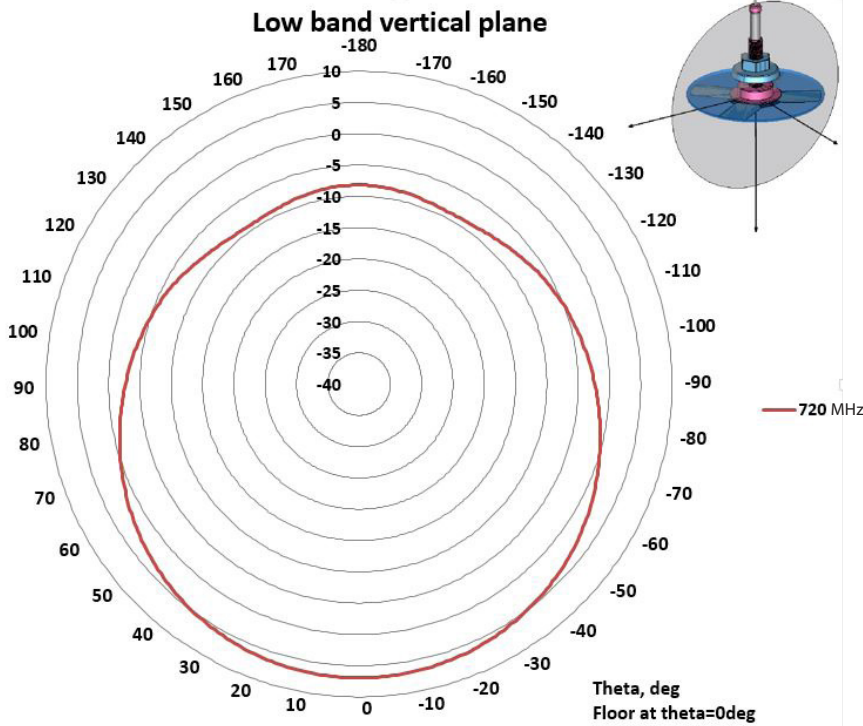

Radiation Patterns for
DASUTCCR500NF, DASUTWCR500NF,
DASUTCCR500MD, DASUTWCR500MD
and DASUTCCR5004310,
DASUTWCR5004310
i.e. antennas WITH
Reflector DASUTCCACC1

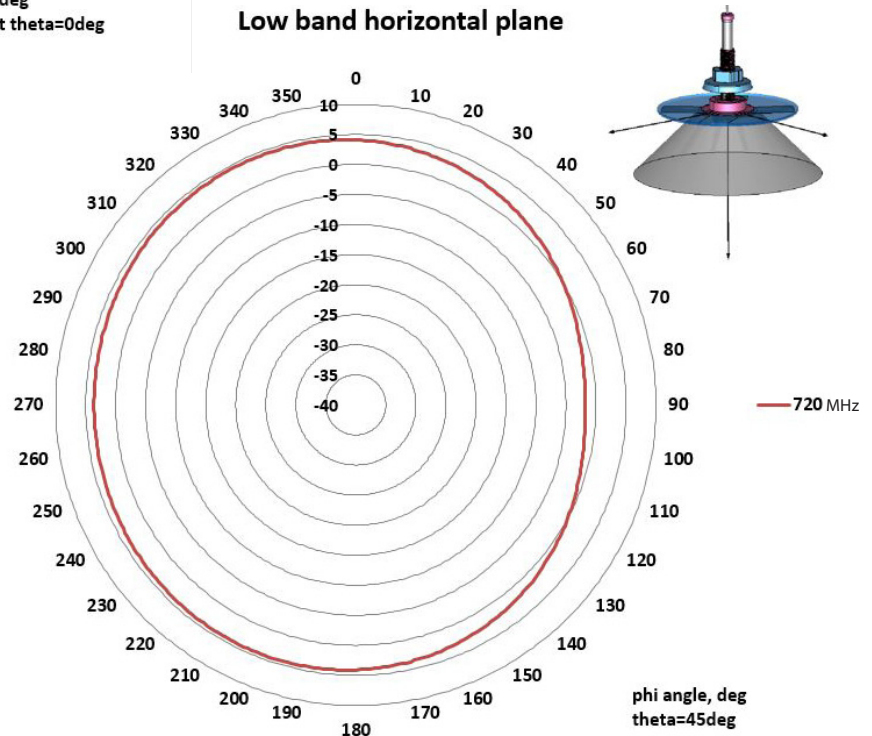

San Diego, California
858 674 8100

Vancouver, Washington
360 944 7551

Europe
49 173 659 8521

China
86 512 69206053

Clarity Series™

Translucent & White DAS Antenna Family
Ultra-Thin, Ceiling-Mount Omni Antenna

Featuring PIMinator® Low PIM Performance

Mid band vertical plane

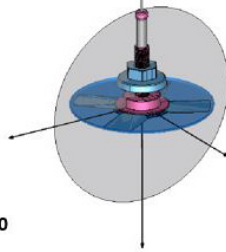
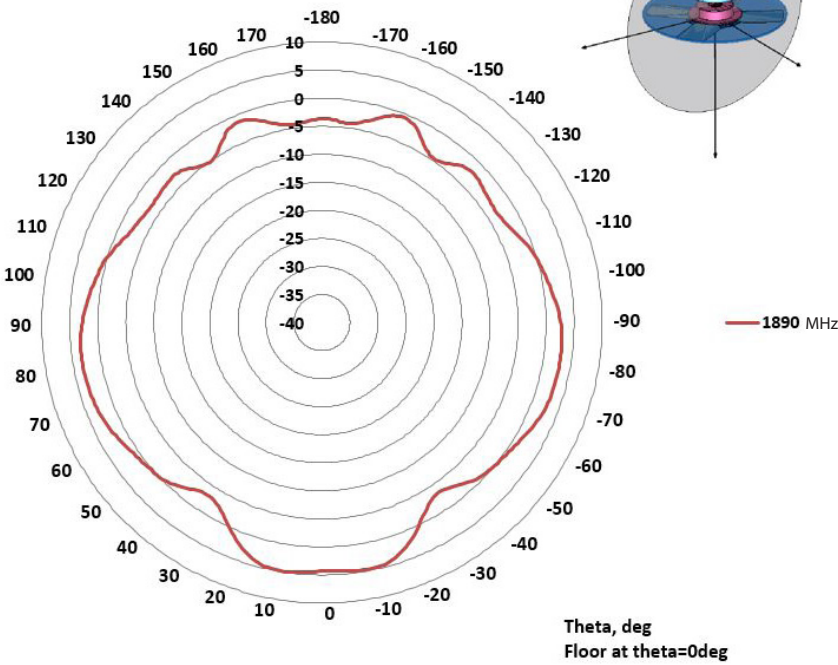

Radiation Patterns for
DASUTCCR500NF, DASUTWCR500NF,
DASUTCCR500MD, DASUTWC4500MD
and DASUTCCR5004310,
DASUTWCR5004310
i.e. antennas WITH
Reflector DASUTCCACC1

Mid band horizontal plane

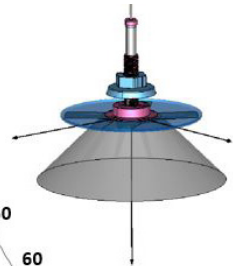
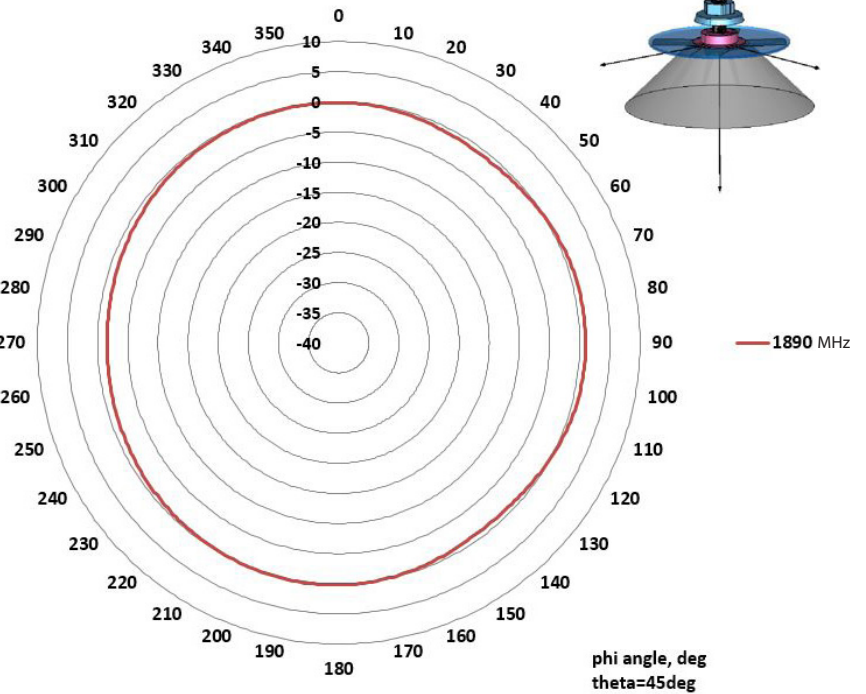

San Diego, California
858 674 8100

Vancouver, Washington
360 944 7551

Europe
49 173 659 8521

China
86 512 69206053

Clarity Series™ Translucent & White DAS Antenna Family Ultra-Thin, Ceiling-Mount Omni Antenna

Featuring PIMinator® Low PIM Performance

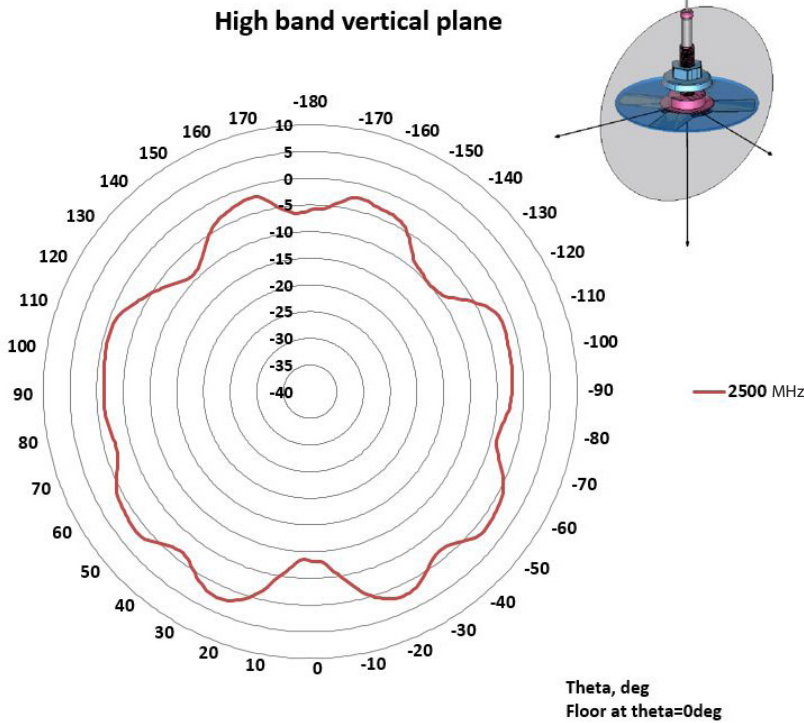

Radiation Patterns for
DASUTCCR500NF, DASUTWCR500NF,
DASUTCCR500MD, DASUTWCR500MD,
and DASUTCCR5004310,
DASUTWCR5004310
i.e. antennas WITH
Reflector DASUTCCACC1

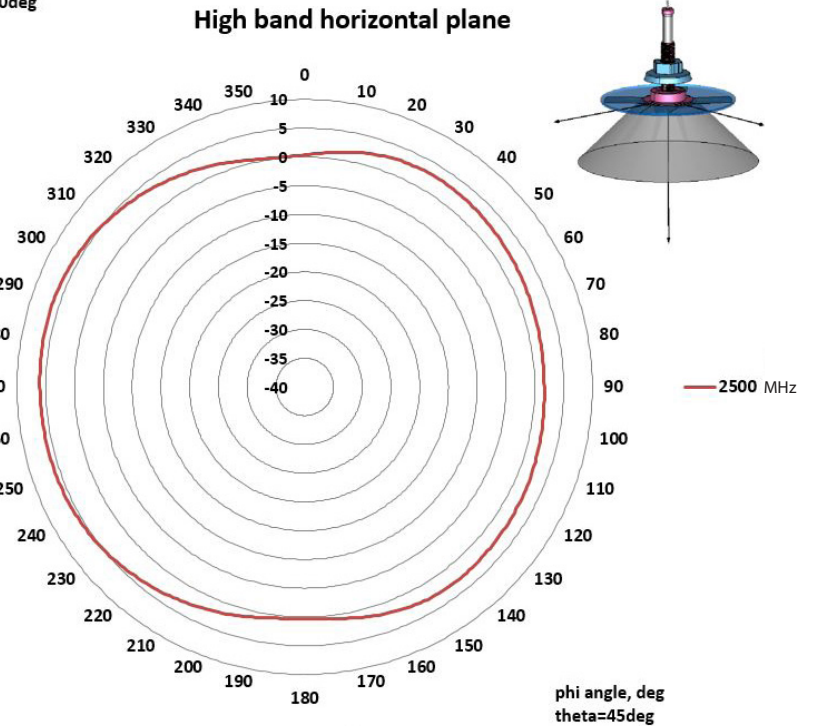

San Diego, California
858 674 8100

Vancouver, Washington
360 944 7551

Europe
49 173 659 8521

China
86 512 69206053

Clarity Series™

Translucent & White DAS Antenna Family
Ultra-Thin, Ceiling-Mount Omni Antenna

Featuring PIMinator® Low PIM Performance

Low band vertical plane

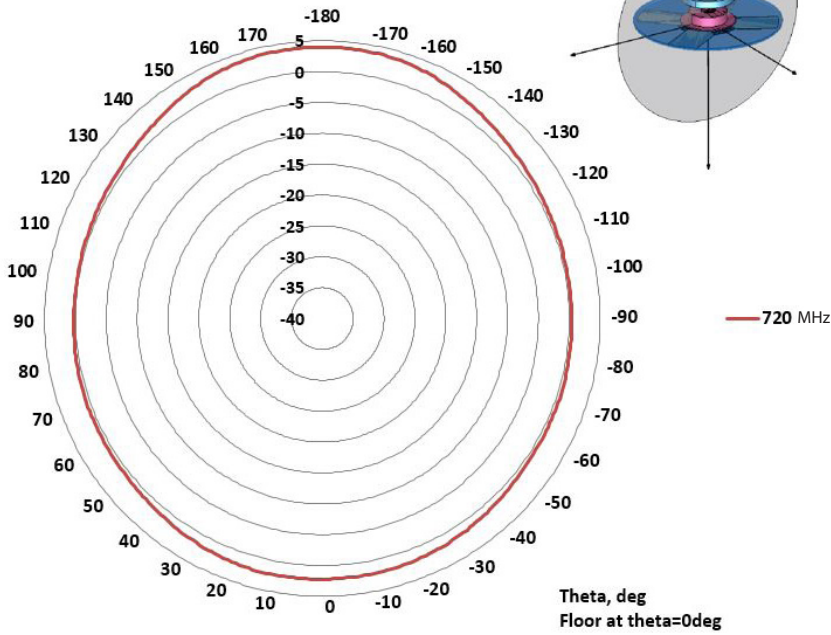

Radiation Patterns for
DASUTCC500NF, DASUTWC500NF,
DASUTCC500MD, DASUTWC500MD,
and DASUTCC5004310,
DASUTWC5004310
i.e. antennas WITHOUT
Reflector DASUTCCACC1

Low band horizontal plane

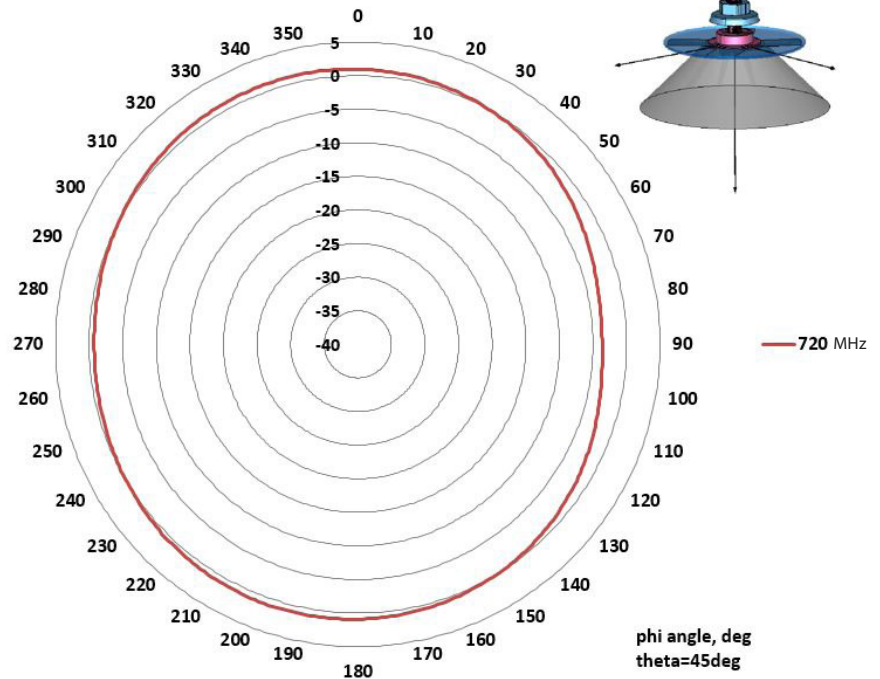

San Diego, California
858 674 8100

Vancouver, Washington
360 944 7551

Europe
49 173 659 8521

China
86 512 69206053

Clarity Series™

Translucent & White DAS Antenna Family
Ultra-Thin, Ceiling-Mount Omni Antenna

Featuring PIMinator® Low PIM Performance

Mid band vertical plane

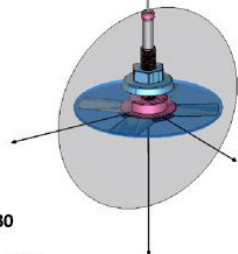
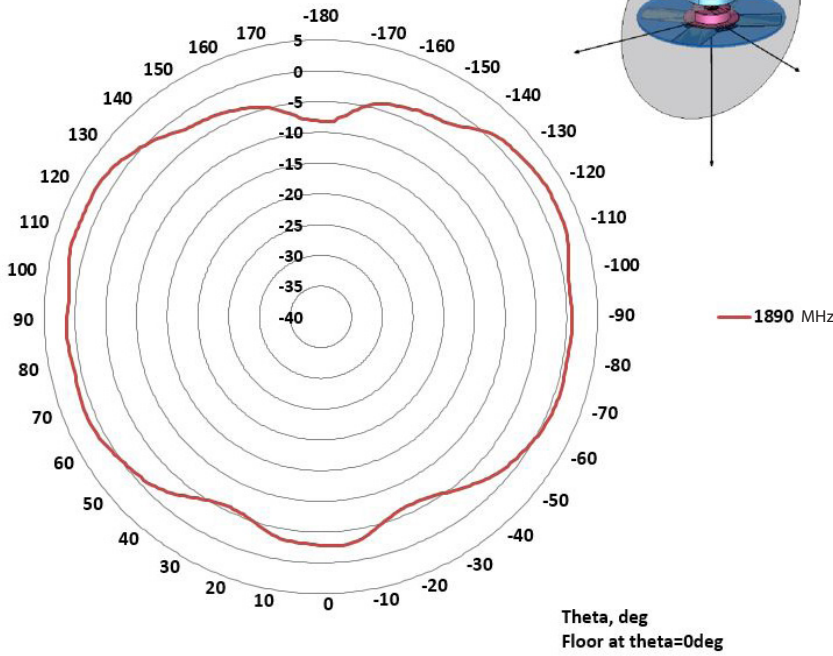

Radiation Patterns for
DASUTCC500NF, DASUTWC500NF,
DASUTCC500MD, DASUTWC500MD,
DASUTCC5004310,
DASUTWC5004310
i.e. antennas WITHOUT
Reflector DASUTCCACC1

Mid band horizontal plane

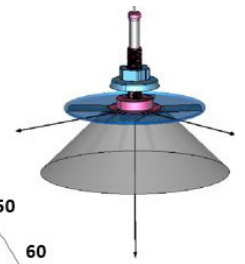
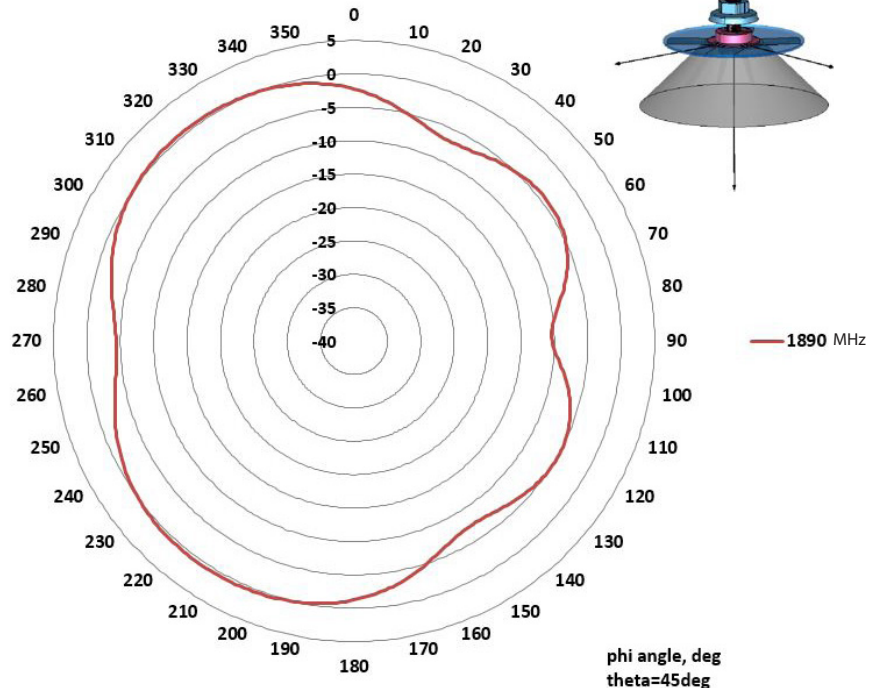

San Diego, California
858 674 8100

Vancouver, Washington
360 944 7551

Europe
49 173 659 8521

China
86 512 69206053

Clarity Series™

Translucent & White DAS Antenna Family
Ultra-Thin, Ceiling-Mount Omni Antenna

Featuring PIMinator® Low PIM Performance

High band vertical plane

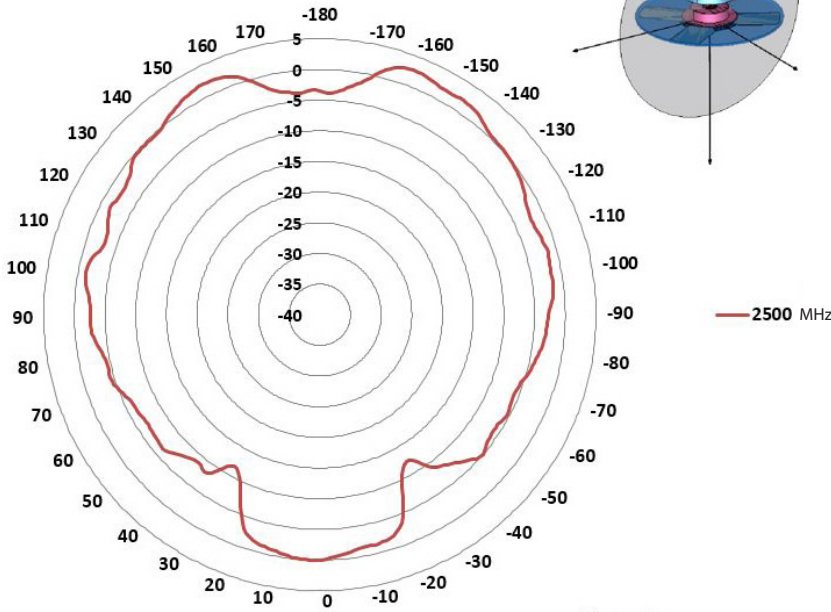

Radiation Patterns for
DASUTCC500NF, DASUTWC500NF,
DASUTCC500MD, DASUTWC500MD,
and DASUTCC5004310,
DASUTWC5004310
i.e. antennas WITHOUT
Reflector DASUTCCACC1

High band horizontal plane

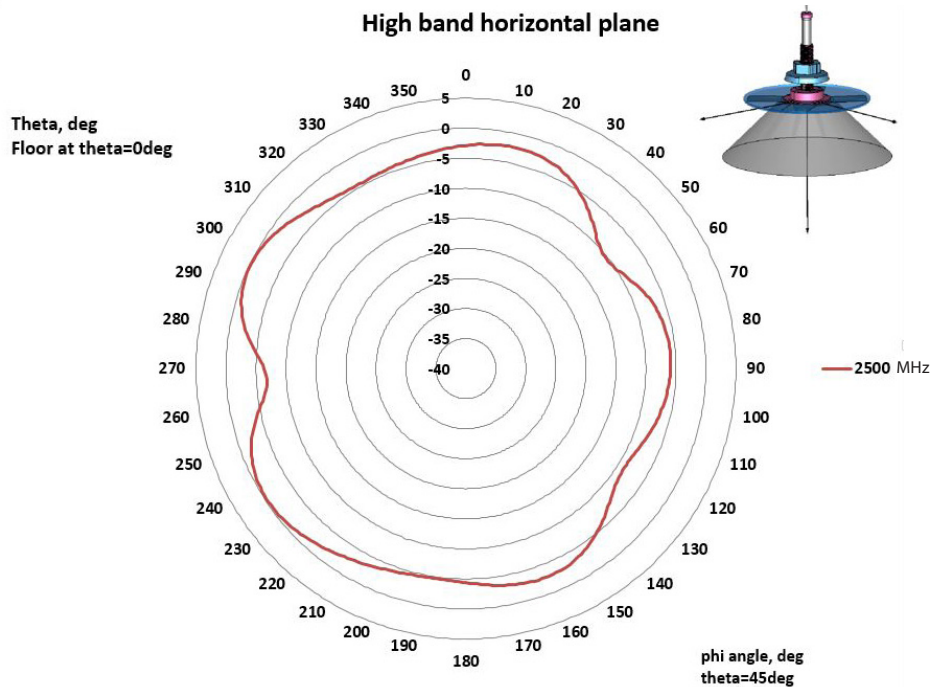

San Diego, California
858 674 8100

Vancouver, Washington
360 944 7551

Europe
49 173 659 8521

China
86 512 69206053

Clarity Series™

Translucent & White DAS Antenna Family

Ultra-Thin, Ceiling-Mount Omni Antenna

Items	Pulse Part Number	Function	Material, Size	Comments
Above-Ceiling Antenna Reflector	DASUTCCACC1	Energy directive reflector	Aluminum 411.8x38.6mm (16.2x52 Inch)	Enhances Gain
Above-Ceiling Antenna Holder	DASACHOLDER	Support antennas above ceiling tile rails.	Polycarbonate; 618x192x122 mm (24.4x7.6x4.4 inch)	Low PIM; Rigid Construction
Clarity Solid-Ceiling Adapter	DASCLINSERT	Blind-hole installation of Clarity Antennas.	94 mm dia (3.7 inch dia)	Low PIM Installation
PIM-Blocker Absorber	DASACABSORBER	System PIM Reduction	500x500x50mm (19.7x12.7x1.97 inch)	Up to 30dB PIM Improvement

Above-Ceiling Reflector



Above-Ceiling Antenna Holder



Above-Ceiling Antenna Holder (Shown with Antenna Installed)

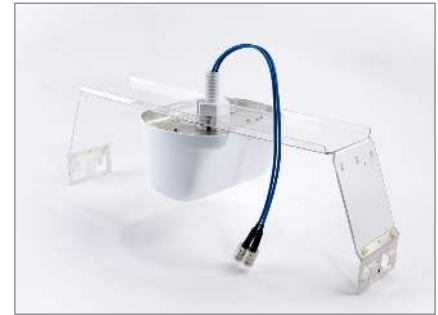

DAS PIM-Blocker Absorber



Clarity Solid-Ceiling Adapter

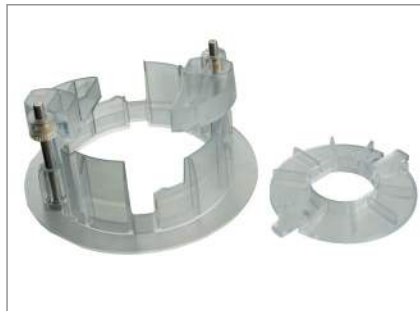

Typical Assembly using the Clarity Installation Adapter

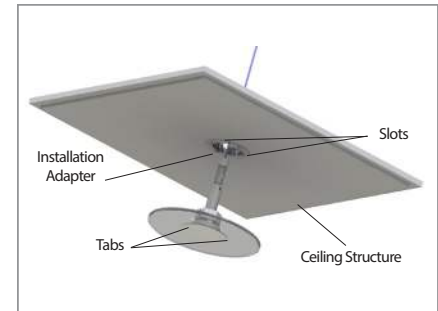

Clarity-Pearl Series	Pulse Part Number	FREQ MHz	PIM Rating dBc	Connector	Color
Public Safety DAS Antenna	PSUTWCNF	380-570; 698-960	N/A	N-Female	White

Public Safety DAS Antenna



San Diego, California
858 674 8100

Vancouver, Washington
360 944 7551

Europe
49 173 659 8521

China
86 512 69206053