

## Features

- Zener Voltage From 5.1V to 200V
- Halogen Free Available Upon Request By Adding Suffix "-HF"
- Epoxy Meets UL 94 V-0 Flammability Rating
- Lead Free Finish/RoHS Compliant (Note1)("P" Suffix Designates Compliant. See Ordering Information)

## Maximum Ratings

- Operating Junction Temperature Range(Note2): -55°C to +200°C
- Storage Temperature Range: -55°C to +200°C
- Maximum Thermal Resistance: 15°C/W from Junction to Lead
- Maximum Thermal Resistance: 83°C/W from Junction to Ambient

Parameter	Symbol	Rating	Conditions
Power Dissipation	P <sub>D</sub>	5.0W	T <sub>L</sub> =75°C
Power Derating		67mW/°C	Above 75°C
Maximum Forward Voltage	V <sub>F</sub>	1.2V	I <sub>F</sub> =1.0A

Note:

1. High Temperature Solder Exemption Applied, See EU Directive Annex 7a.
2. Max Operating Temperature for DC Conditions is 150°C, But not to Exceed 200°C for Pulsed Conditions With Low Duty Cycle or Non-Repetitive.

# 5 Watt Zener Diode 5.1 to 200 Volts

## DO-15

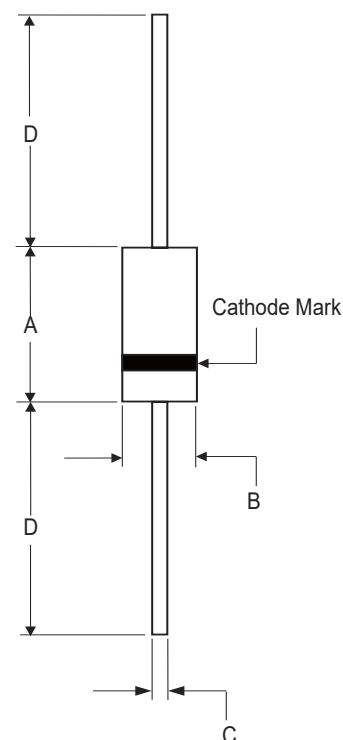

### DIMENSIONS

DIM	INCHES		MM		NOTE
	MIN	MAX	MIN	MAX	
A	0.230	0.300	5.80	7.60	
B	0.104	0.140	2.60	3.60	
C	0.026	0.035	0.70	0.90	
D	1.000	-----	25.40	-----	

**Electrical Characteristics @ 25°C Unless Otherwise Specified**

MCC Part Number	Regulator Voltage	Test Current	Maximum Dynamic Impedance	Maximum Reverse Current	Test Voltage	Maximum Regulator Current	Maximum Dynamic Knee Impedance	Maximum Surge Current	Maximum Voltage Regulation	MARKING CODE
	$V_Z$	$I_Z$	$Z_{ZT}$	$I_R$	$V_R$	$I_{ZM}$	$Z_{ZK} @ 1.0mA$	$I_{ZSM}$		
	V	mA	$\Omega$	$\mu A$	V	mA	$\Omega$	A	V	
1N5338B	5.1	240	1.5	1	1	930	400	14.4	0.39	1N5338B
1N5339B	5.6	220	1	1	2	865	400	13.4	0.25	1N5339B
1N5340B	6	200	1	1	3	790	300	12.7	0.19	1N5340B
1N5341B	6.2	200	1	1	3	765	200	12.4	0.1	1N5341B
1N5342B	6.8	175	1	10	5.2	700	200	11.5	0.15	1N5342B
1N5343B	7.5	175	1.5	10	5.7	630	200	10.7	0.15	1N5343B
1N5344B	8.2	150	1.5	10	6.2	580	200	10	0.2	1N5344B
1N5345B	8.7	150	2	10	6.6	545	200	9.5	0.2	1N5345B
1N5346B	9.1	150	2	7.5	6.9	520	150	9.2	0.22	1N5346B
1N5347B	10	125	2	5	7.6	475	125	8.6	0.22	1N5347B
1N5348B	11	125	2.5	5	8.4	430	125	8	0.25	1N5348B
1N5349B	12	100	2.5	2	9.1	395	125	7.5	0.25	1N5349B
1N5350B	13	100	2.5	1	9.9	365	100	7	0.25	1N5350B
1N5351B	14	100	2.5	1	10.6	340	75	6.7	0.25	1N5351B
1N5352B	15	75	2.5	1	11.5	315	75	6.3	0.25	1N5352B
1N5353B	16	75	2.5	1	12.2	295	75	6	0.3	1N5353B
1N5354B	17	70	2.5	0.5	12.9	280	75	5.8	0.35	1N5354B
1N5355B	18	65	2.5	0.5	13.7	264	75	5.5	0.4	1N5355B
1N5356B	19	65	3	0.5	14.4	250	75	5.3	0.4	1N5356B
1N5357B	20	65	3	0.5	15.2	237	75	5.1	0.4	1N5357B
1N5358B	22	50	3.5	0.5	16.7	216	75	4.7	0.45	1N5358B
1N5359B	24	50	3.5	0.5	18.2	198	100	4.4	0.55	1N5359B
1N5360B	25	50	4	0.5	19	190	110	4.3	0.55	1N5360B
1N5361B	27	50	5	0.5	20.6	176	120	4.1	0.6	1N5361B
1N5362B	28	50	6	0.5	21.2	170	130	3.9	0.6	1N5362B
1N5363B	30	40	8	0.5	22.8	158	140	3.7	0.6	1N5363B
1N5364B	33	40	10	0.5	25.1	144	150	3.5	0.6	1N5364B
1N5365B	36	30	11	0.5	27.4	132	160	3.3	0.65	1N5365B
1N5366B	39	30	14	0.5	29.7	122	170	3.1	0.65	1N5366B
1N5367B	43	30	20	0.5	32.7	110	190	2.8	0.7	1N5367B
1N5368B	47	25	25	0.5	35.8	100	210	2.7	0.8	1N5368B
1N5369B	51	25	27	0.5	38.8	93	230	2.5	0.9	1N5369B
1N5370B	56	20	35	0.5	42.6	86	280	2.3	1	1N5370B
1N5371B	60	20	40	0.5	45.5	79	350	2.2	1.2	1N5371B
1N5372B	62	20	42	0.5	47.1	76	400	2.1	1.35	1N5372B
1N5373B	68	20	44	0.5	51.7	70	500	2	1.5	1N5373B
1N5374B	75	20	45	0.5	56	63	620	1.9	1.6	1N5374B
1N5375B	82	15	65	0.5	62.2	58	720	1.8	1.8	1N5375B
1N5376B	87	15	75	0.5	66	54.5	760	1.7	2	1N5376B
1N5377B	91	15	75	0.5	69.2	52.5	760	1.6	2.2	1N5377B
1N5378B	100	12	90	0.5	76	47.5	800	1.5	2.3	1N5378B
1N5379B	110	12	125	0.5	83.6	43	1000	1.4	2.5	1N5379B
1N5380B	120	10	170	0.5	91.2	39.5	1150	1.3	2.5	1N5380B
1N5381B	130	10	190	0.5	98.8	36.6	1250	1.2	2.5	1N5381B
1N5382B	140	8	230	0.5	106	34	1500	1.2	2.5	1N5382B
1N5383B	150	8	330	0.5	114	31.6	1500	1.1	3	1N5383B
1N5384B	160	8	350	0.5	122	29.4	1650	1.1	3	1N5384B
1N5385B	170	8	380	0.5	129	28	1750	1	3	1N5385B
1N5386B	180	5	430	0.5	137	26.4	1750	1	4	1N5386B
1N5387B	190	5	450	0.5	144	25	1850	0.9	5	1N5387B
1N5388B	200	5	480	0.5	152	23.6	1850	0.9	5	1N5388B

**Remarks:**

1. Devices Listed Have a  $\pm 5\%$  Tolerance on Nominal VZ. Suffix C Denotes a +2%
2. ZENER VOLTAGE (Vz) AND IMPEDANCE (Z<sub>ZT</sub> & Z<sub>ZK</sub>) - Test conditions for Zener voltage and impedance are as follows; I<sub>Z</sub> is applied 40+/-10 ms prior to reading. Mounting contacts are located from the inside edge of mounting clips to the body of the diode(T<sub>A</sub>=25°C)
3. SURGE CURRENT (I<sub>r</sub>) - Surge current is specified as the maximum allowable peak, non-recurrent square-wave current with a pulse width, PW, of 8.3 ms. The data given in Figure 5 may be used to find the maximum surge current for a square wave of any pulse width between 1 ms and 1000ms by plotting the applicable points on logarithmic paper. Examples of this, using the 6.8v, is shown in Figure 6. Mounting contact located as specified in Note 3. (T<sub>A</sub>=25 °C).
4. VOLTAGE REGULATION (V<sub>Z</sub>) - Test conditions for voltage regulation are as follows: V<sub>Z</sub> measurements are made at 10% and then at 50% of the I<sub>Z</sub> max value listed in the electrical characteristics table. The test currents are the same for the 5% and 10% tolerance devices. The test current time duration for each V<sub>Z</sub> measurement is 40+/- 10 ms. (T<sub>A</sub>=25C ). Mounting contact located as specified in Note2.
5. MAXIMUM REGULATOR CURRENT (I<sub>ZM</sub>) - The maximum current shown is based on the maximum voltage of a 5% type unit. Therefore, it applies only to the B-suffix device. The actual I<sub>ZM</sub> for any device may not exceed the value of 5 watts divided by the actual V<sub>Z</sub> of the device. T<sub>L</sub>=75C at maximum from the device body.

**APPLICATION NOTE:**

Since the actual voltage available from a given Zener diode is temperature dependent, it is necessary to determine junction temperature under any set of operating conditions in order to calculate its value. The following procedure is recommended:

Lead Temperature, T<sub>L</sub>, should be determined from:

$$T_L = \theta_{LA} P_D + T_A$$

$\theta_{LA}$  is the lead-to-ambient thermal resistance and P<sub>D</sub> is the power dissipation.

Junction Temperature, T<sub>J</sub>, may be found from:

$$T_J = T_L + \Delta T_{JL}$$

$\Delta T_{JL}$  is the increase in junction temperature above the lead temperature and may be found from Figure 7 for a train of power pulses or from Figure 1 for dc power.

$$\Delta T_{JL} = \theta_{JL} P_D$$

For worst-case design, using expected limits of I<sub>Z</sub>, limits of P<sub>D</sub> and the extremes of T<sub>J</sub> ( $\Delta T_J$ ) may be estimated. Changes in voltage, V<sub>Z</sub>, can then be found from:

$$\Delta V = \theta_{VZ} \Delta T_J$$

$\theta_{VZ}$ , the Zener voltage temperature coefficient,

Under high power-pulse operation, the Zener voltage will vary with time and may also be affected significantly by the zener resistance. For best regulation, keep current excursions as low as possible.

Data of Figure 7 should not be used to compute surge capability. Surge limitations are given in Figure 5. They are lower than would be expected by considering only junction temperature, as current crowding effects cause temperatures to be extremely high in small spots resulting in device degradation should the limits of Figure 5 be exceeded.

**Curve Characteristics**

Fig. 1 - Power Derating Curve

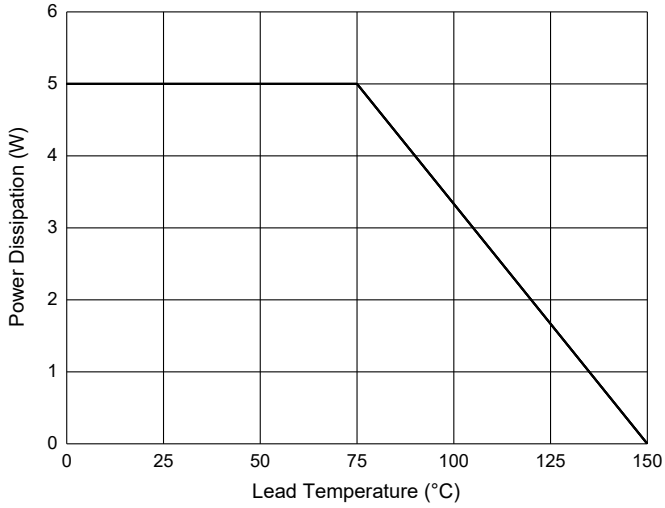

Fig. 2 - Typical Zener Breakdown Characteristics

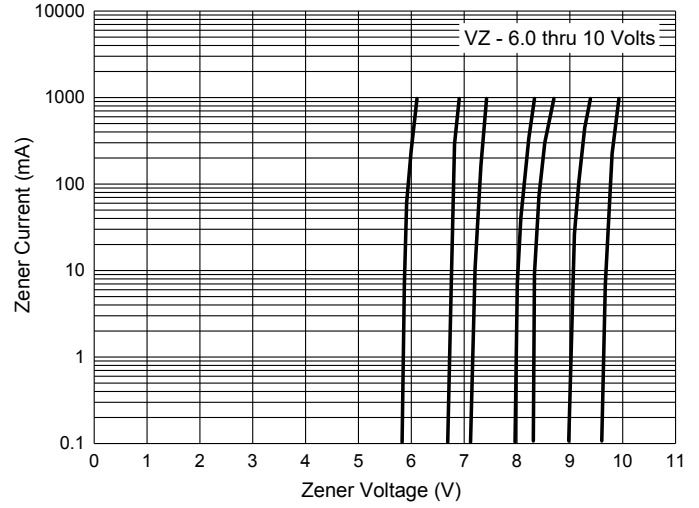

Fig. 3 - Typical Zener Breakdown Characteristics

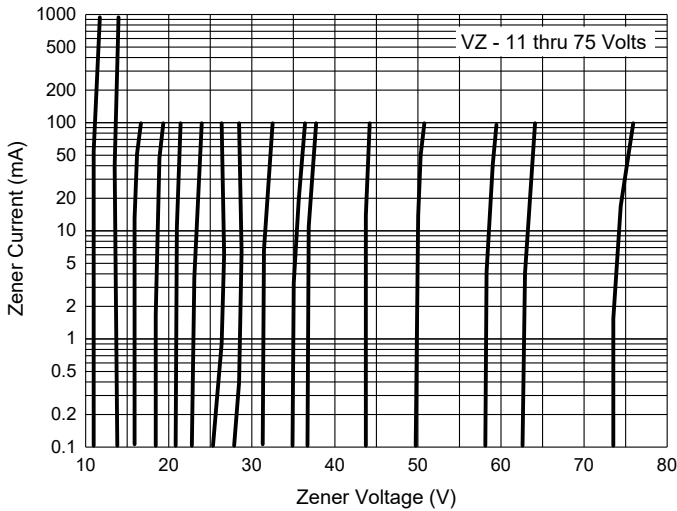

Fig. 4 - Typical Zener Breakdown Characteristics

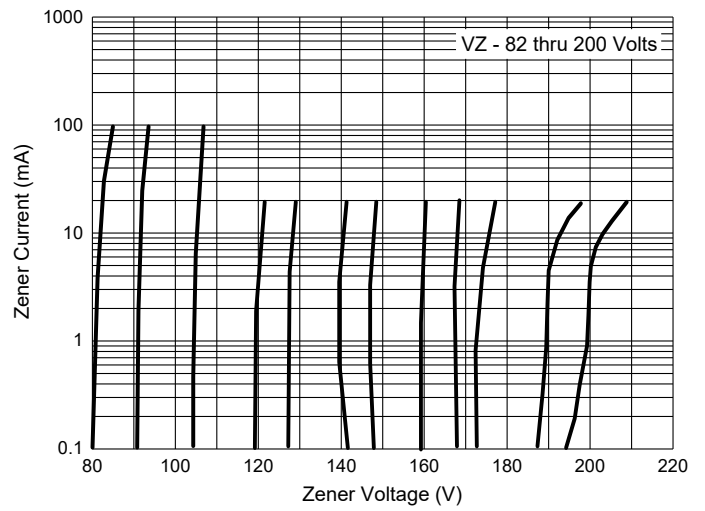

Fig. 5 - Surge Current Characteristics

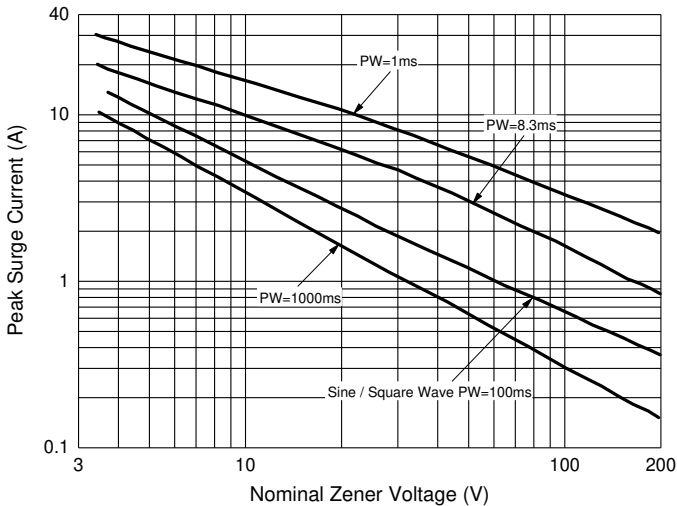
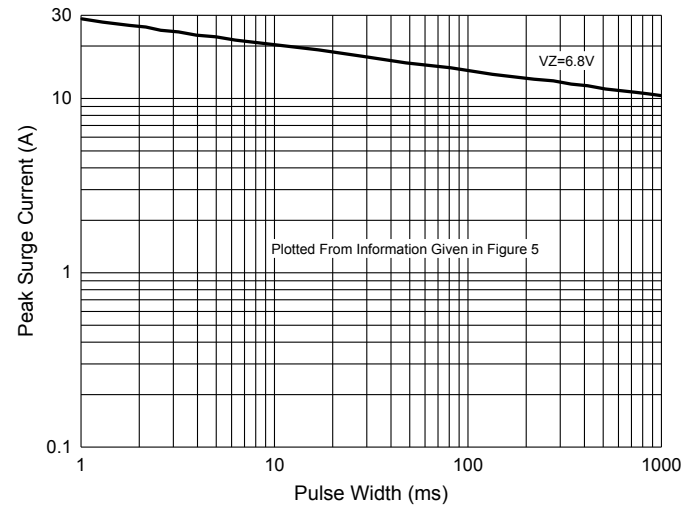
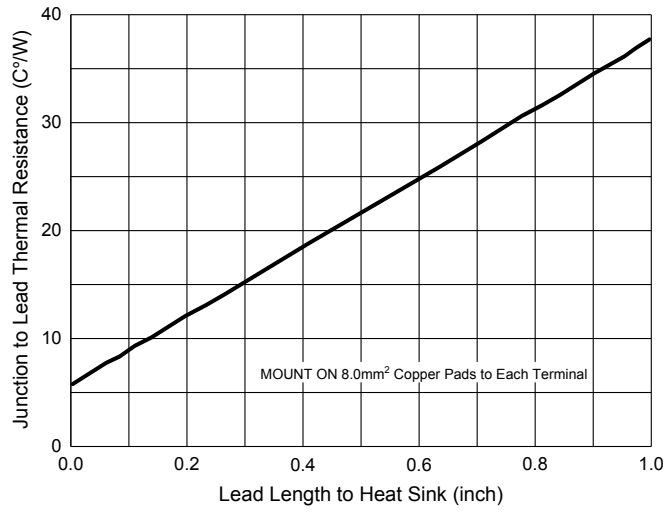

Fig. 6 - Peak Surge Current VS Pulse Width



## Curve Characteristics

Fig. 7 - Typical Thermal Resistance



## Ordering Information

Device	Packing
(Part Number)-TP	Tape&Reel: 4Kpcs/Reel
(Part Number)-AP	Ammo Packing: 3Kpcs/Ammo Box
(Part Number)-BP	Bulk:500pcs/Box,25Kpcs/Carton

Note : Adding "-HF" Suffix For Halogen Free, eg. Part Number-TP-HF

### \*\*\*IMPORTANT NOTICE\*\*\*

**Micro Commercial Components Corp.** reserves the right to make changes without further notice to any product herein to make corrections, modifications , enhancements , improvements , or other changes . **Micro Commercial Components Corp .** does not assume any liability arising out of the application or use of any product described herein; neither does it convey any license under its patent rights ,nor the rights of others . The user of products in such applications shall assume all risks of such use and will agree to hold **Micro Commercial Components Corp .** and all the companies whose products are represented on our website, harmless against all damages. **Micro Commercial Components Corp.** products are sold subject to the general terms and conditions of commercial sale, as published at <https://www.mccsemi.com/Home/TermsAndConditions>.

### \*\*\*LIFE SUPPORT\*\*\*

MCC's products are not authorized for use as critical components in life support devices or systems without the express written approval of Micro Commercial Components Corporation.

### \*\*\*CUSTOMER AWARENESS\*\*\*

Counterfeiting of semiconductor parts is a growing problem in the industry. Micro Commercial Components (MCC) is taking strong measures to protect ourselves and our customers from the proliferation of counterfeit parts. MCC strongly encourages customers to purchase MCC parts either directly from MCC or from Authorized MCC Distributors who are listed by country on our web page cited below. Products customers buy either from MCC directly or from Authorized MCC Distributors are genuine parts, have full traceability, meet MCC's quality standards for handling and storage. **MCC will not provide any warranty coverage or other assistance for parts bought from Unauthorized Sources.** MCC is committed to combat this global problem and encourage our customers to do their part in stopping this practice by buying direct or from authorized distributors.