

NCP57152, NCV57152

Fast Transient Response Regulator, VLDO, 1.5 A

The NCP57152 is a high precision, very low dropout (VLDO), low minimum input voltage and low ground current positive voltage regulator that is capable of providing an output current in excess of 1.5 A with a typical dropout voltage of 330 mV at 1.5 A load current and input voltage from 1.8 V and up. The devices are stable with ceramic output capacitors.

The device can withstand up to 18 V max input voltage. Internal protection features consist of output current limiting, in thermal shutdown and reverse output current protection. Logic level enable and error flag pins are available.

The NCP57152 is an Adjustable Voltage device and is available in D2PAK-5 and DFN8 packages.

Features

- Output Current in Excess of 1.5 A
- Minimum Operating Input Voltage 1.8 V for Full 1.5 A Output Current
- 330 mV Typical Dropout Voltage at 1.5 A
- Adjustable Output Voltage Range from 1.24 V to 13 V
- Low Ground Current
- Fast Transient Response
- Stable with Ceramic Output Capacitor
- Logic Compatible Enable and Error Flag Pins
- Current Limit, Reverse Current and Thermal Shutdown Protection
- Operation up to 13.5 V Input Voltage
- NCV Prefix for Automotive and Other Applications Requiring Unique Site and Control Change Requirements; AEC-Q100 Qualified and PPAP Capable
- These are Pb-Free Devices

Applications

- Consumer and Industrial Equipment Point of Regulation
- Servers and Networking Equipment
- FPGA, DSP and Logic Power Supplies
- Switching Power Supply Post Regulation
- Battery Chargers
- Functional Replacement for Industry Standard MIC29150, MIC39150, MIC37150 with Improved Minimum Input Voltage Specification



ON Semiconductor®

<http://onsemi.com>

MARKING DIAGRAMS

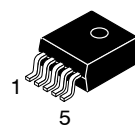

D2PAK
CASE 936A

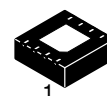
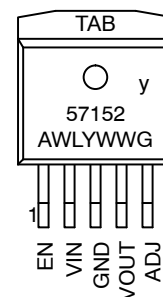

DFN8
CASE 488AF

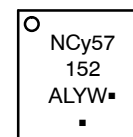

y = P (NCP), V (NCV)
A = Assembly Location
WL, L = Wafer Lot
Y = Year
WW, W = Work Week
G, ■ = Pb-Free Package

(*Note: Microdot may be in either location)

ORDERING INFORMATION

See detailed ordering and shipping information in the package dimensions section on page 9 of this data sheet.

NCP57152, NCV57152

TYPICAL APPLICATIONS

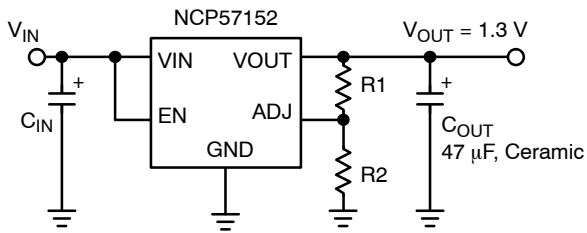

Figure 1. Adjustable Regulator

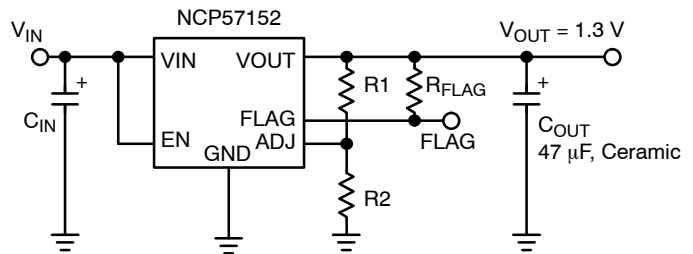

Figure 2. Adjustable Regulator in DFN Package

PIN FUNCTION DESCRIPTION

Pin Number D2PAK-5	Pin Number DFN8	Pin Name	Pin Function
1	2	EN	Enable Input: CMOS and TTL logic compatible. Logic high = enable; Logic low = shutdown.
2	3	VIN	Input voltage which supplies both the internal circuitry and the current to the output load.
3	1	GND	Ground
4	6	VOUT	Linear Regulator Output.
5	7	ADJ	Adjustable Regulator Feedback Input. Connect to output voltage resistor divider central node.
TAB	-	TAB	TAB is connected to ground.
-	8	FLG	Error Flag Open collector output. Active-low indicates an output fault condition.
-	EP	EXPOSED PAD	PAD for removing heat from the device. Must be connected to GND.
-	4, 5	NC	Not internally connected.

NCP57152, NCV57152

ABSOLUTE MAXIMUM RATINGS

Symbol	Rating	Value	Unit
V _{IN}	Supply Voltage	0 to 18	V
V _{EN}	Enable Input Voltage	0 to 18	V
V _{FLG}	Error Flag Open Collector Output Maximum Voltage	0 to 18	V
V _{OUT} – V _{IN}	Reverse V _{OUT} – V _{IN} Voltage (EN = Shutdown or Vin = 0 V) (Note 1)	0 to 6.5	V
P _D	Power Dissipation (Notes 2 and 5)	Internally Limited	
T _J	Junction Temperature	–40 ≤ T _J ≤ +125	°C
T _S	Storage Temperature	–65 ≤ T _J ≤ +150	°C
	ESD Rating (Notes 3 and 4)	Human Body Model Machine Model	2000 200

Stresses exceeding Maximum Ratings may damage the device. Maximum Ratings are stress ratings only. Functional operation above the Recommended Operating Conditions is not implied. Extended exposure to stresses above the Recommended Operating Conditions may affect device reliability.

NOTE: All voltages are referenced to GND pin unless otherwise noted.

- The ENABLE pin input voltage must be ≤ 0.8 V or Vin must be connected to ground potential.
- $P_{D(max)} = (T_{J(max)} - T_A) / R_{\theta JA}$, where $R_{\theta JA}$ depends upon the printed circuit board layout.
- Devices are ESD sensitive. Handling precautions recommended.
- This device series incorporates ESD protection and is tested by the following methods:
ESD Human Body Model (HBM) tested per AEC-Q100-002 (EIA/JESD22-A114C)
ESD Machine Model (MM) tested per AEC-Q100-003 (EIA/JESD22-A115C)
This device contains latch-up protection and exceeds 100 mA per JEDEC Standard JESD78.
- This protection is not guaranteed outside the Recommended Operating Conditions.

RECOMMENDED OPERATING CONDITIONS (Note 6)

Symbol	Rating	Value	Unit
V _{IN}	Supply Voltage	1.8 to 13.5	V
V _{EN}	Enable Input Voltage	0 to 13.5	V
V _{FLG}	Error Flag Open Collector Voltage	0 to 13.5	V
T _J	Junction Temperature	–40 ≤ T _J ≤ +125	°C

- The device is not guaranteed to function outside it's Recommended operating conditions.

NCP57152, NCV57152

ELECTRICAL CHARACTERISTICS

$T_J = 25^\circ\text{C}$ with $V_{IN} = V_{OUT\text{ nominal}} + 0.6\text{ V}$; $V_{EN} = V_{IN}$; $I_L = 10\text{ mA}$; bold values indicate $-40^\circ\text{C} < T_J < +125^\circ\text{C}$, unless noted. (Note 7)

Parameter	Conditions	Min	Typ	Max	Unit
Output Voltage Accuracy DFN package	$I_L = 10\text{ mA}$	-1		1	%
	$10\text{ mA} < I_{OUT} < 1.5\text{ A}$, $V_{OUT\text{ nominal}} + 0.6 \leq V_{IN} \leq 13.5\text{ V}$	-2		2	%
Output Voltage Accuracy D2PAK package	$I_L = 10\text{ mA}$	-1.5		1.5	%
	$10\text{ mA} < I_{OUT} < 1.5\text{ A}$, $V_{OUT\text{ nominal}} + 0.6 \leq V_{IN} \leq 13.5\text{ V}$	-2.5		2.5	%
Output Voltage Line Regulation	$V_{IN} = V_{OUT\text{ nominal}} + 0.6\text{ V}$ to 13.5 V ; $I_L = 10\text{ mA}$		0.02	0.5	%
Output Voltage Load Regulation	$I_L = 10\text{ mA}$ to 1.5 A		0.2	1.0	%
$V_{IN} - V_{OUT}$ Dropout Voltage (Note 8)	$I_L = 500\text{ mA}$ (Note 9)		180	295	mV
	$I_L = 750\text{ mA}$		220	350	mV
	$I_L = 1.0\text{ A}$ (Note 9)		260	410	mV
	$I_L = 1.5\text{ A}$		330	520	mV
Ground Pin Current (Note 10)	$I_L = 1.5\text{ A}$		40	60 80	mA
Ground Pin Current in Shutdown	$V_{EN} \leq 0.5\text{ V}$		1.0	5.0	μA
Overload Protection Current Limit	$V_{OUT} = 0\text{ V}$		2.0	3.0	A
Start-up Time	$V_{EN} = V_{IN}$, $V_{OUT\text{ nominal}} = 2.5\text{ V}$, $I_{OUT} = 10\text{ mA}$, $C_{OUT} = 47\text{ }\mu\text{F}$		100	500	μs
Output Voltage Start-up Slope	$V_{EN} = V_{IN}$, $I_{OUT} = 10\text{ mA}$, $C_{OUT} = 47\text{ }\mu\text{F}$ (Note 11)		40	200	$\mu\text{s/V}$
Reference Voltage	DFN Package	1.228 1.215	1.240	1.252 1.265	V
	D ² PAK Package	1.221 1.209	1.240	1.259 1.271	V
Adjust Pin Bias Current			100	200 350	nA

ENABLE INPUT

Enable Input Signal Levels	Regulator Enable	1.4			V
	Regulator Shutdown			0.8	V
Enable Pin Input Current	$V_{EN} \leq 0.8\text{ V}$ (Regulator Shutdown)			2.0 4.0	μA
	$6.5\text{ V} > V_{EN} \geq 1.4\text{ V}$ (Regulator enable)		15	30 40	μA

FLAG OUTPUT

$I_{FLG(\text{leak})}$	$V_{oh} = 13.5\text{ V}$, Flag OFF			1.0 2.0	μA
$V_{FLG(\text{Lo})}$	$V_{IN} = 1.8\text{ V}$, $I_{FLG} = 1\text{ mA}$, Flag ON		210	400 500	mV
V_{FLG}	Low Threshold, % of particular V_{OUT}	93	95		%
	Hysteresis, % of particular V_{OUT}		2		%
	High Threshold, % of particular V_{OUT}		97	99.2	%

7. $V_{OUT\text{ nominal}}$ can be set by external resistor divider in the application. Tested for $V_{OUT\text{ nominal}} = 1.24\text{ V}$ unless noted.

8. $V_{DO} = V_{IN} - V_{OUT}$ when V_{OUT} decreases to 98% of its nominal output voltage with $V_{IN} = V_{OUT} + 1\text{ V}$. Tested for $V_{OUT\text{ nominal}} = 2.5\text{ V}$.

9. Guaranteed by design.

10. $I_{IN} = I_{GND} + I_{OUT}$.

11. Device Start-up Time = Output Voltage Start-up Slope * $V_{OUT\text{ nominal}}$.

Package	Conditions / PCB Footprint	Thermal Resistance
D2PAK-5, Junction-to-Case		$R_{\theta JC} = 2.1^\circ\text{C/W}$
D2PAK-5, Junction-to-Air	PCB with 100 mm^2 2.0 oz Copper Heat Spreading Area	$R_{\theta JA} = 52^\circ\text{C/W}$
DFN8, Junction-to-Air	PCB with 500 mm^2 2.0 oz Copper Heat Spreading Area	$R_{\theta JA} = 75^\circ\text{C/W}$

TYPICAL CHARACTERISTICS

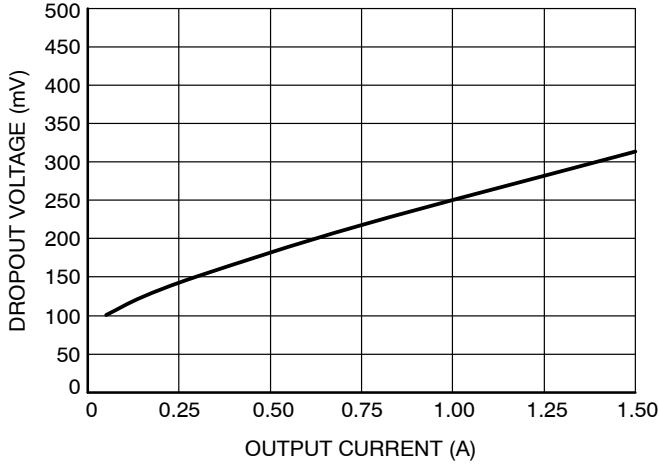

Figure 3. Dropout Voltage vs. Output Current
($V_{OUTnom} = 2.5\text{ V}$)

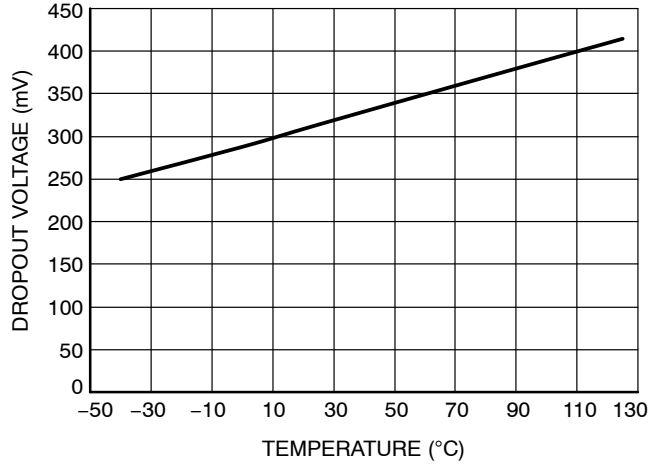

Figure 4. Dropout Voltage vs. Temperature
($V_{OUTnom} = 2.5\text{ V}$, $I_{OUT} = 1.5\text{ A}$)

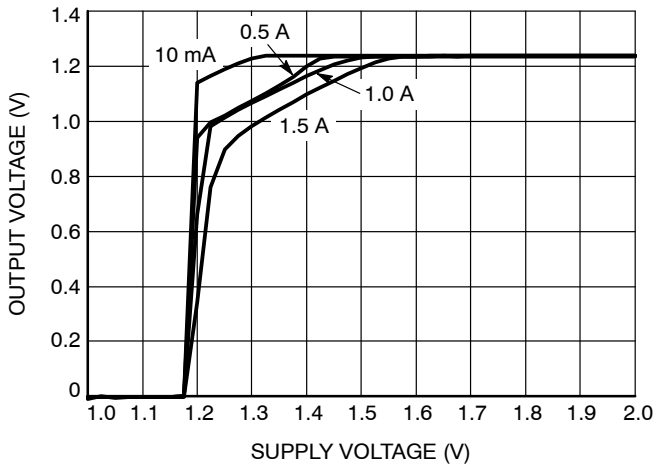

Figure 5. Dropout Characteristics
($V_{OUTnom} = 1.24\text{ V}$)

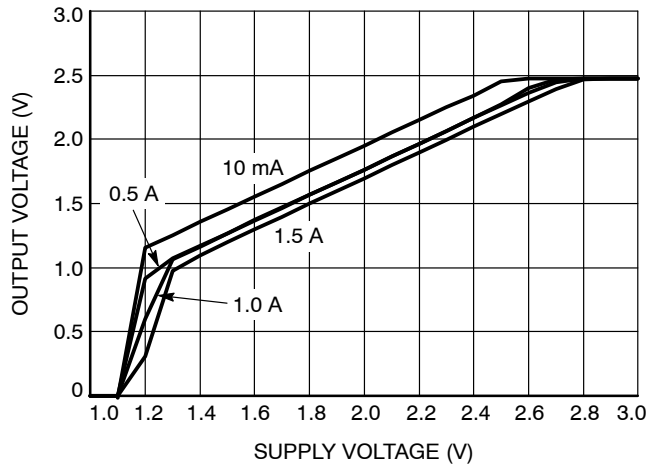

Figure 6. Dropout Characteristics
($V_{OUTnom} = 2.5\text{ V}$)

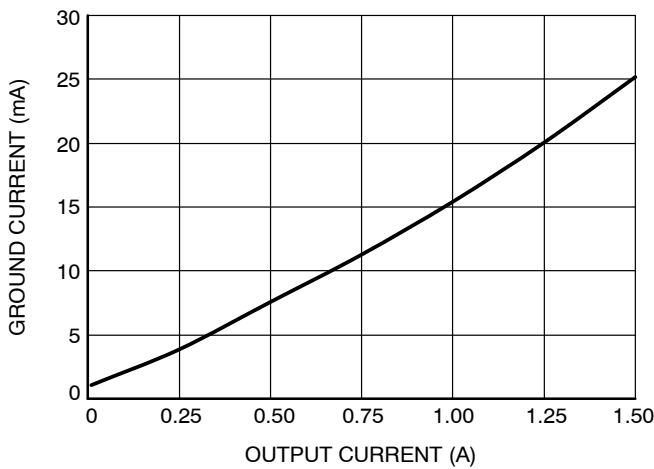

Figure 7. Ground Current vs. Output Current
($V_{OUTnom} = 1.24\text{ V}$)

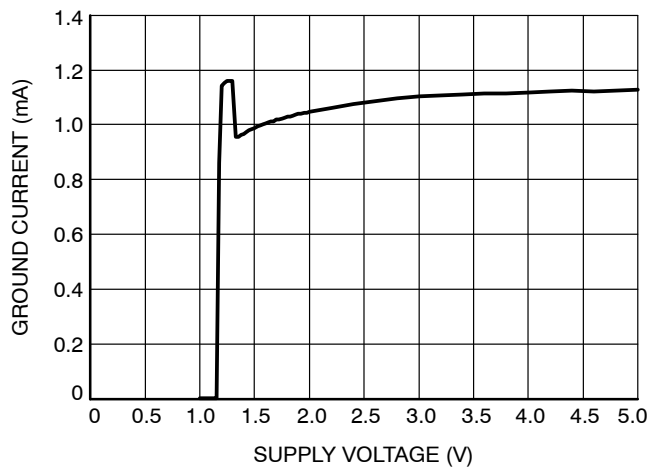

Figure 8. Ground Current vs. Supply Voltage
($V_{OUTnom} = 1.24\text{ V}$, $I_{OUT} = 10\text{ mA}$)

TYPICAL CHARACTERISTICS

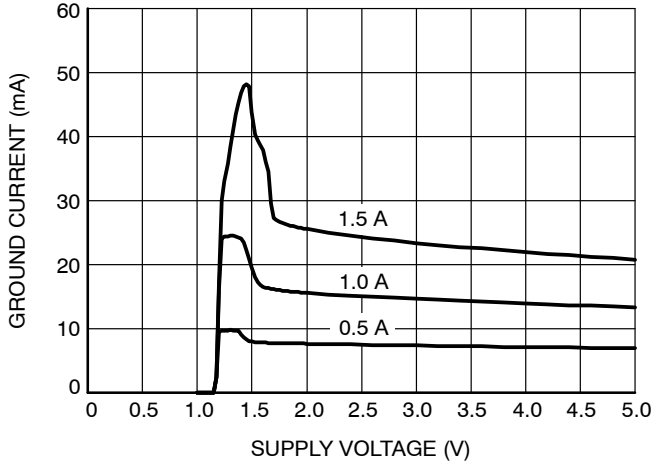

Figure 9. Ground Current vs. Supply Voltage ($V_{OUTnom} = 1.24\text{ V}$)

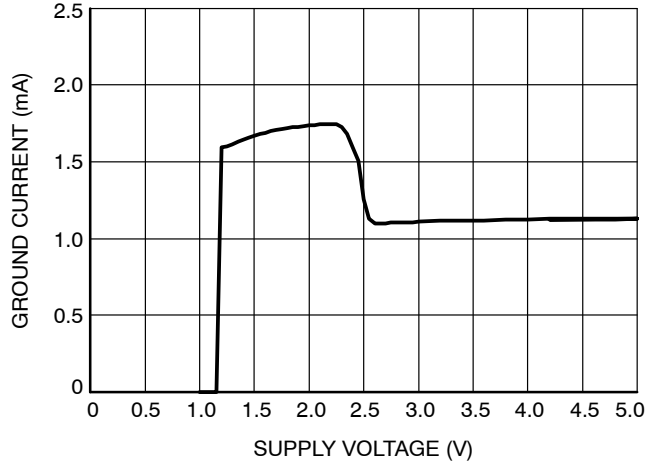

Figure 10. Ground Current vs. Supply Voltage ($V_{OUTnom} = 2.5\text{ V}$, $I_{OUT} = 10\text{ mA}$)

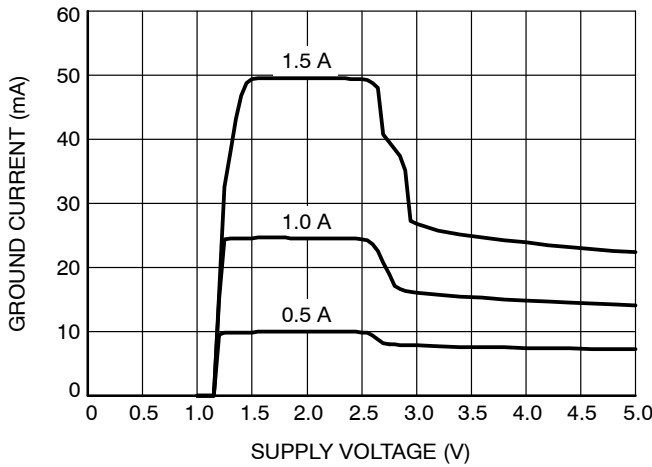

Figure 11. Ground Current vs. Supply Voltage ($V_{OUTnom} = 2.5\text{ V}$)

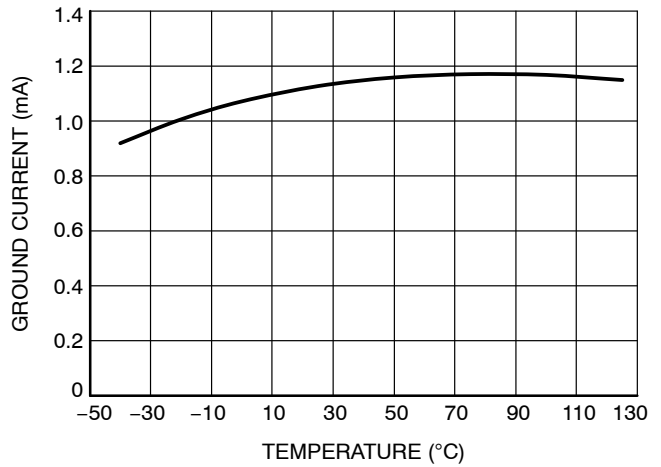

Figure 12. Ground Current vs. Temperature ($V_{OUTnom} = 2.5\text{ V}$, $I_{OUT} = 10\text{ mA}$, $V_{IN} = 3.5\text{ V}$)

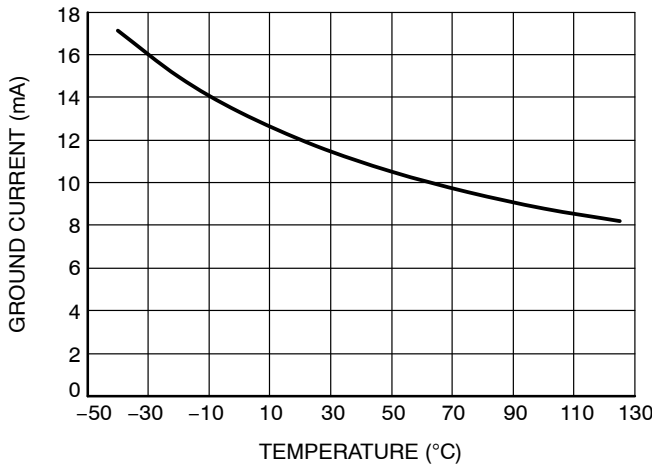

Figure 13. Ground Current vs. Temperature ($V_{OUTnom} = 2.5\text{ V}$, $I_{OUT} = 0.75\text{ A}$, $V_{IN} = 3.5\text{ V}$)

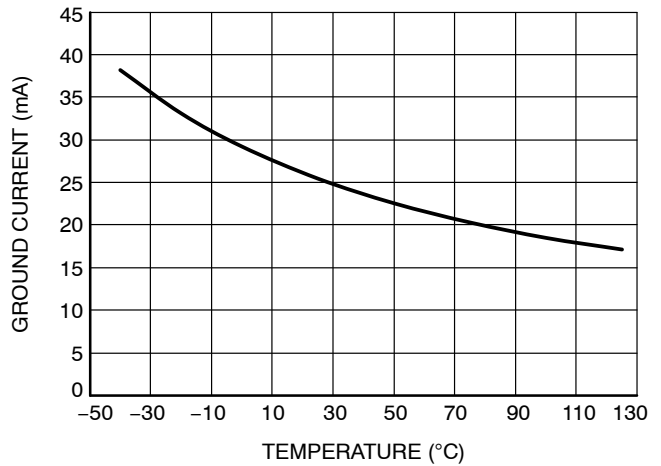

Figure 14. Ground Current vs. Temperature ($V_{OUTnom} = 2.5\text{ V}$, $I_{OUT} = 1.5\text{ A}$, $V_{IN} = 3.5\text{ V}$)

TYPICAL CHARACTERISTICS

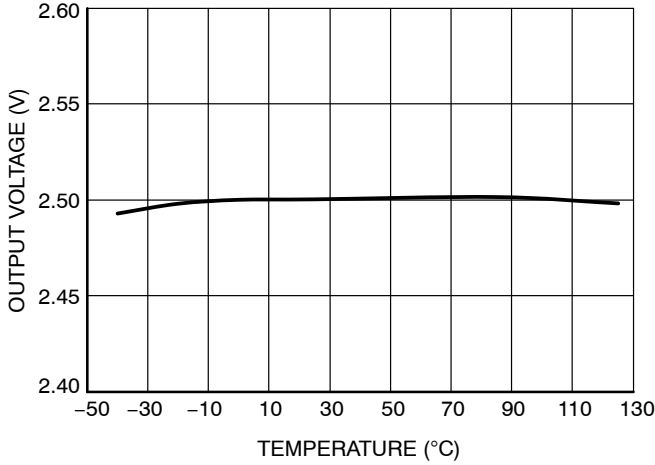

Figure 15. Output Voltage vs. Temperature
($V_{OUTnom} = 2.5\text{ V}$, $I_{OUT} = 10\text{ mA}$)

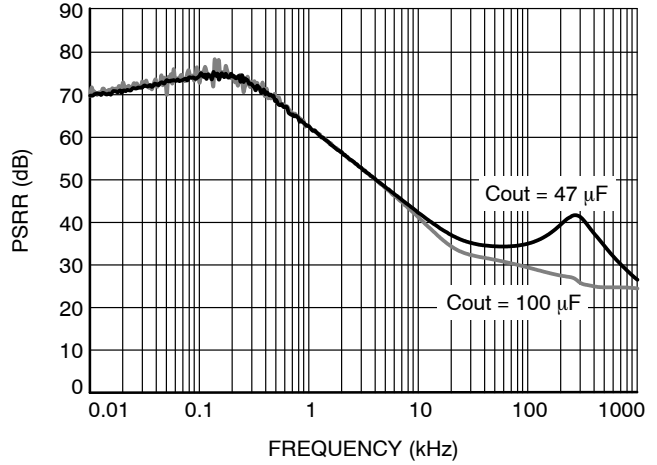

Figure 16. PSRR vs. Frequency, $V_{in} = 3.5\text{ V} + 200\text{ mVpp}$ Modulation, $V_{out} = 2.5\text{ V}$, $I_{out} = 0.5\text{ A}$

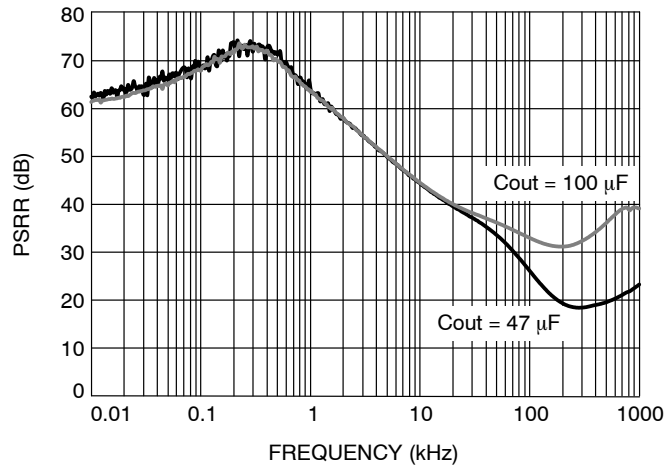

Figure 17. PSRR vs. Frequency, $V_{in} = 3.5\text{ V} + 200\text{ mVpp}$ Modulation, $V_{out} = 2.5\text{ V}$, $I_{out} = 1.5\text{ A}$

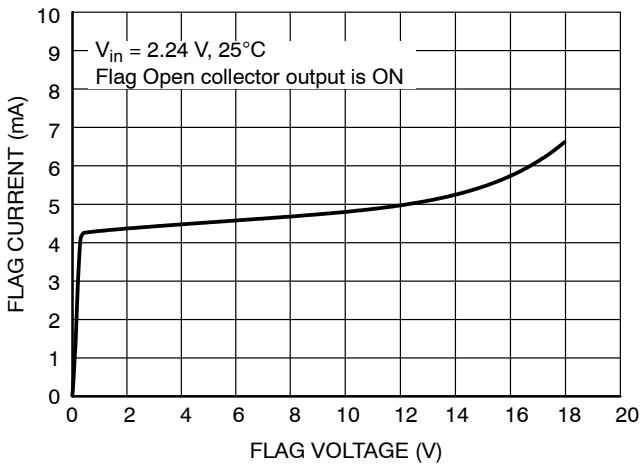

Figure 18. Flag Current vs. Flag Voltage

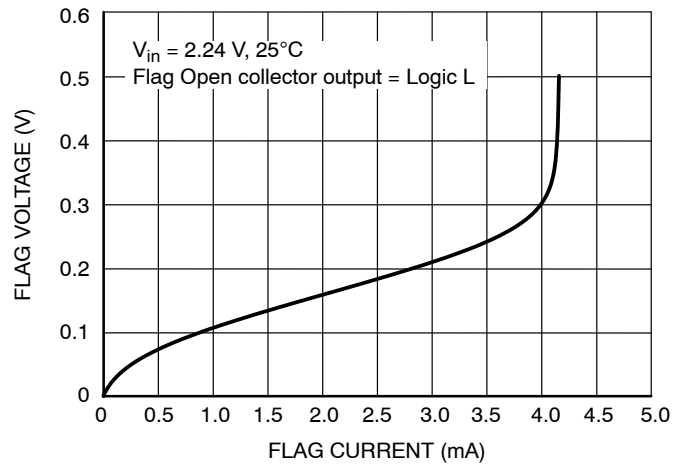

Figure 19. Flag Voltage vs. Flag Current

TYPICAL CHARACTERISTICS

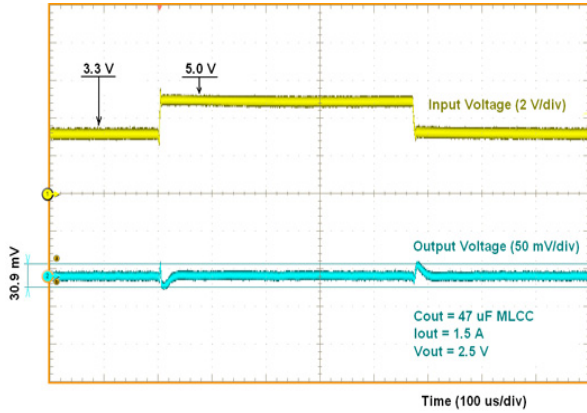

Figure 20. Line Transient Response

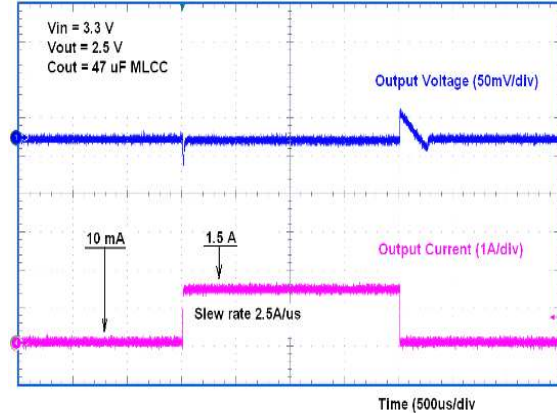

Figure 21. Load Transient Response

APPLICATIONS INFORMATION

Output Capacitor and Stability

The NCP57152 requires an output capacitor for stable operation. The NCP57152 is designed to operate with ceramic output capacitors. The recommended output capacitance value is 47 μF or greater. Such capacitors help to improve transient response and noise reduction at high frequency.

Input Capacitor

An input capacitor of 1.0 μF or greater is recommended when the device is more than 4 inches away from the bulk supply capacitance, or when the supply is a battery. Small, surface-mount chip capacitors can be used for the bypassing. The capacitor should be placed within 1 inch of the device for optimal performance. Larger values will help to improve ripple rejection by bypassing the input of the regulator, further improving the integrity of the output voltage.

Minimum Load Current

The NCP57152 regulator is specified between finite loads. A 5 mA minimum load current is necessary for proper operation.

Enable Input

NCP57152 regulators also feature an enable input for on/off control of the device. Its shutdown state draws “zero” current from input voltage supply (only microamperes of leakage). The enable input is TTL/CMOS compatible for simple logic interface, but can be connected up to V_{IN} .

Error Flag

NCP57152 devices in DFN package feature an error flag circuit that monitors the output voltage and signals an error condition when the voltage is 5% below the nominal output voltage. The error flag is an open-collector output that can sink up to 5 mA typically during a V_{OUT} fault condition.

The FLG output is overload protected when a short circuit of the pullup load resistor occurs in the application. This is guaranteed in the full range of FLG output voltage Max ratings (see Max Ratings table). Please be aware operation in this mode is not recommended, power dissipated in the device can impact on output voltage precision and other device characteristics.

Overcurrent and Reverse Output Current Protection

The NCP57152 regulator is fully protected from damage due to output current overload and output short conditions. When NCP57152 output is overloaded, Output Current limiting is provided. This limiting is linear; output current during overload or output short conditions is constant. These features are advantageous for powering FPGAs and other ICs having current consumption higher than nominal during their startup.

Thermal shutdown disables the NCP57152 device when the die temperature exceeds the maximum safe operating temperature.

When NCP57152 is disabled and $(V_{OUT} - V_{IN})$ voltage difference is less than 6.5 V in the application, the output structure of these regulators is able to withstand output voltage (backup battery as example) to be applied without reverse current flow. Of course the additional current flowing through the feedback resistor divider needs to be included in the backup battery discharging calculations.

Adjustable Voltage Design

The NCP/NCV57152 Adjustable voltage Device Output voltage is set by the ratio of two external resistors as shown in Figure 22.

The device maintains the voltage at the ADJ pin at 1.24 V referenced to ground. The current in R2 is then equal to $1.24 \text{ V} / R_2$, and the current in R1 is the current in R2 plus

NCP57152, NCV57152

the ADJ pin bias current. The ADJ pin bias current flows from V_{OUT} through R1 into the ADJ pin.

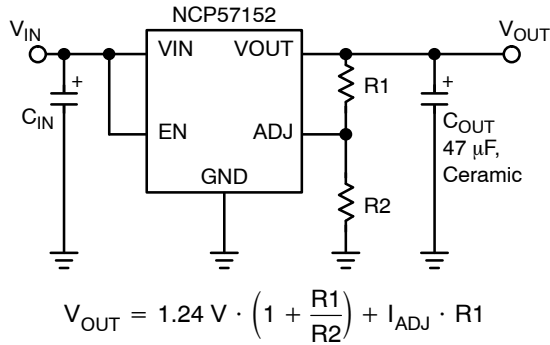

Figure 22. Adjustable Voltage Operation

For the R2 resistor value up to 15 kOhm the I_{ADJ} current impact can be neglected and the R1 resistor value can be calculated by:

$$R1 = R2 \cdot \left(\frac{V_{OUT}}{1.24} - 1\right) \quad (\text{eq. 1})$$

Where V_{OUT} is the desired nominal output voltage.

Thermal Considerations

The power handling capability of the device is limited by the maximum rated junction temperature (125°C). The P_D total power dissipated by the device has two components, Input to output voltage differential multiplied by Output current and Input voltage multiplied by GND pin current.

$$P_D = (V_{IN} - V_{OUT}) \cdot I_{OUT} + V_{IN} \cdot I_{GND} \quad (\text{eq. 2})$$

The GND pin current value can be found in Electrical Characteristics table and in Typical Characteristics graphs.

The Junction temperature T_J is

$$T_J = T_A + P_D \cdot R_{\theta JA} \quad (\text{eq. 3})$$

where T_A is ambient temperature and $R_{\theta JA}$ is the Junction to Ambient Thermal Resistance of the NCP/NCV57152 device mounted on the specific PCB.

To maximize efficiency of the application and minimize thermal power dissipation of the device it is convenient to use the Input to output voltage differential as low as possible.

The static typical dropout characteristics for various output voltage and output current can be found in the Typical Characteristics graphs.

ORDERING INFORMATION

Device	Output Current	Output Voltage	Junction Temp. Range	Package	Shipping [†]
NCP57152MNADJTYG	1.5 A	ADJ	-40°C to +125°C	DFN8-4x4 (Pb-Free)	4000 / Tape & Reel
NCV57152MNADJTYG*	1.5 A	ADJ	-40°C to +125°C	DFN8-4x4 (Pb-Free)	4000 / Tape & Reel
NCP57152DSADJR4G	1.5 A	ADJ	-40°C to +125°C	D2PAK-5 (Pb-Free)	800 / Tape & Reel
NCV57152DSADJR4G*	1.5 A	ADJ	-40°C to +125°C	D2PAK-5 (Pb-Free)	800 / Tape & Reel

[†]For information on tape and reel specifications, including part orientation and tape sizes, please refer to our Tape and Reel Packaging Specifications Brochure, BRD8011/D.

*NCV Prefix for Automotive and Other Applications Requiring Unique Site and Control Change Requirements; AEC-Q100 Qualified and PPAP Capable.

MECHANICAL CASE OUTLINE

PACKAGE DIMENSIONS

ON Semiconductor®

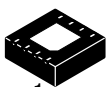

SCALE 2:1

DFN8, 4x4
CASE 488AF-01
ISSUE C

DATE 15 JAN 2009

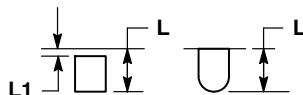
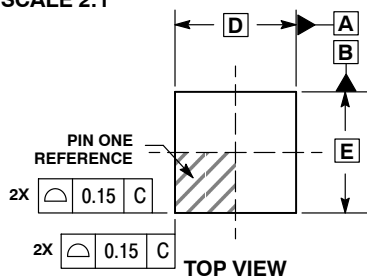

- NOTES:
1. DIMENSIONS AND TOLERANCING PER ASME Y14.5M, 1994.
 2. CONTROLLING DIMENSION: MILLIMETERS.
 3. DIMENSION b APPLIES TO PLATED TERMINAL AND IS MEASURED BETWEEN 0.15 AND 0.30MM FROM TERMINAL TIP.
 4. COPLANARITY APPLIES TO THE EXPOSED PAD AS WELL AS THE TERMINALS.
 5. DETAILS A AND B SHOW OPTIONAL CONSTRUCTIONS FOR TERMINALS.

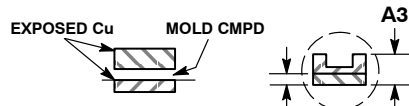
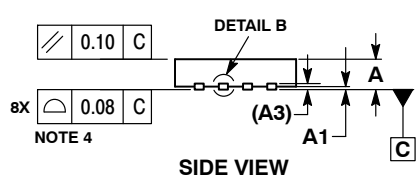

MILLIMETERS		
DIM	MIN	MAX
A	0.80	1.00
A1	0.00	0.05
A3	0.20	REF
b	0.25	0.35
D	4.00	BSC
D2	1.91	2.21
E	4.00	BSC
E2	2.09	2.39
e	0.80	BSC
K	0.20	---
L	0.30	0.50
L1	---	0.15

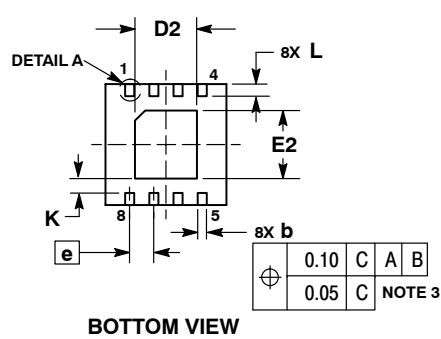

GENERIC MARKING DIAGRAM*

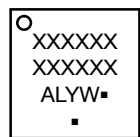

- XXXX = Specific Device Code
- A = Assembly Location
- L = Wafer Lot
- Y = Year
- W = Work Week
- = Pb-Free Package

(Note: Microdot may be in either location)

*This information is generic. Please refer to device data sheet for actual part marking. Pb-Free indicator, "G" or microdot "▪", may or may not be present.

SOLDERING FOOTPRINT*

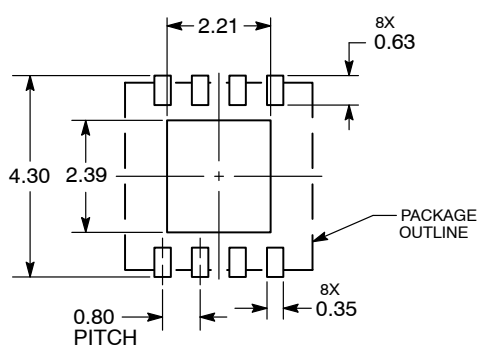

DIMENSIONS: MILLIMETERS

*For additional information on our Pb-Free strategy and soldering details, please download the ON Semiconductor Soldering and Mounting Techniques Reference Manual, SOLDERRM/D.

DOCUMENT NUMBER:	98AON15232D	Electronic versions are uncontrolled except when accessed directly from the Document Repository. Printed versions are uncontrolled except when stamped "CONTROLLED COPY" in red.
DESCRIPTION:	DFN8, 4X4, 0.8P	PAGE 1 OF 1

ON Semiconductor and ON are trademarks of Semiconductor Components Industries, LLC dba ON Semiconductor or its subsidiaries in the United States and/or other countries. ON Semiconductor reserves the right to make changes without further notice to any products herein. ON Semiconductor makes no warranty, representation or guarantee regarding the suitability of its products for any particular purpose, nor does ON Semiconductor assume any liability arising out of the application or use of any product or circuit, and specifically disclaims any and all liability, including without limitation special, consequential or incidental damages. ON Semiconductor does not convey any license under its patent rights nor the rights of others.

MECHANICAL CASE OUTLINE

PACKAGE DIMENSIONS

ON Semiconductor®

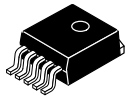

D²PAK 5-LEAD CASE 936A-02 ISSUE E

DATE 28 JUL 2021

SCALE 1:1

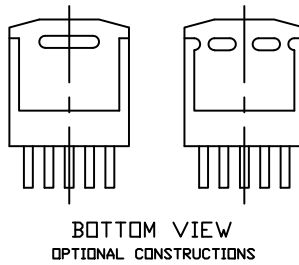
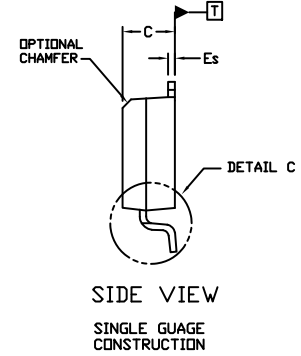
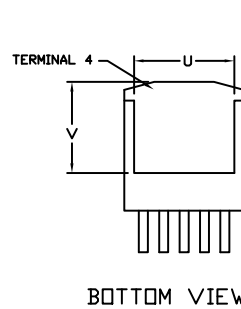
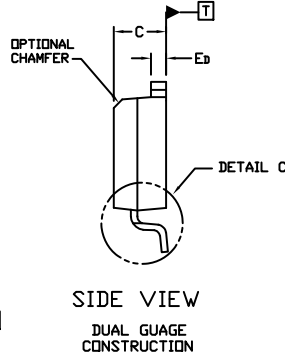
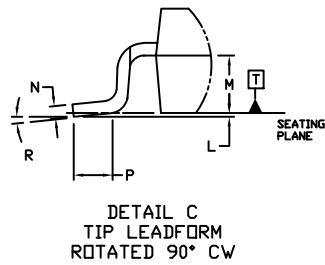
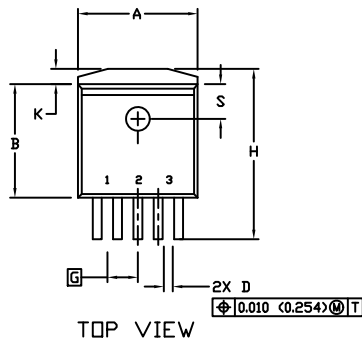

NOTES:

1. DIMENSIONING AND TOLERANCING PER ANSI Y14.5M, 1982.
2. CONTROLLING DIMENSION INCHES
3. TAB CONTOUR OPTIONAL WITHIN DIMENSIONS A AND K.
4. DIMENSIONS U AND V ESTABLISH A MINIMUM MOUNTING SURFACE FOR TERMINAL 4.
5. DIMENSIONS A AND B DO NOT INCLUDE MOLD FLASH OR GATE PROTRUSIONS. MOLD FLASH AND GATE PROTRUSIONS NOT TO EXCEED 0.025 (0.635) MAXIMUM.

DIM	INCHES		MILLIMETERS	
	MIN.	MAX.	MIN.	MAX.
A	0.396	0.403	9.804	10.236
B	0.356	0.368	9.042	9.347
C	0.170	0.180	4.318	4.572
D	0.026	0.036	0.660	0.914
Ed	0.045	0.055	1.143	1.397
Es	0.018	0.026	0.457	0.660
G	0.067 BSC		1.702 BSC	
H	0.539	0.579	13.691	14.707
K	0.050 REF		1.270 REF	
L	0.000	0.010	0.000	0.254
M	0.088	0.102	2.235	2.591
N	0.018	0.026	0.457	0.660
P	0.058	0.078	1.473	1.981
R	0°	8°	0°	8°
S	0.116 REF		2.946 REF	
U	0.200 MIN		5.080 MIN	
V	0.250 MIN		6.350 MIN	

GENERIC MARKING DIAGRAM*

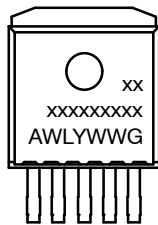

- xxxxxx = Device Code
- A = Assembly Location
- WL = Wafer Lot
- Y = Year
- WW = Work Week
- G = Pb-Free Package

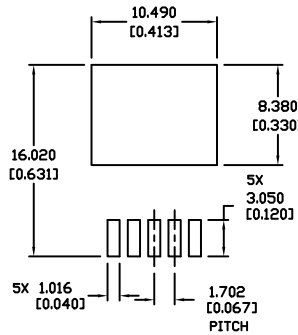

* For additional information on our Pb-Free strategy and soldering details, please download the ON Semiconductor Soldering and Mounting Techniques Reference Manual, SOLDERRM/D.

*This information is generic. Please refer to device data sheet for actual part marking. Pb-Free indicator, "G" or microdot "•", may or may not be present. Some products may not follow the Generic Marking.

DOCUMENT NUMBER:	98ASH01006A	Electronic versions are uncontrolled except when accessed directly from the Document Repository. Printed versions are uncontrolled except when stamped "CONTROLLED COPY" in red.
DESCRIPTION:	D2PAK 5-LEAD	PAGE 1 OF 1

ON Semiconductor and are trademarks of Semiconductor Components Industries, LLC dba ON Semiconductor or its subsidiaries in the United States and/or other countries. ON Semiconductor reserves the right to make changes without further notice to any products herein. ON Semiconductor makes no warranty, representation or guarantee regarding the suitability of its products for any particular purpose, nor does ON Semiconductor assume any liability arising out of the application or use of any product or circuit, and specifically disclaims any and all liability, including without limitation special, consequential or incidental damages. ON Semiconductor does not convey any license under its patent rights nor the rights of others.

onsemi, **Onsemi**, and other names, marks, and brands are registered and/or common law trademarks of Semiconductor Components Industries, LLC dba "**onsemi**" or its affiliates and/or subsidiaries in the United States and/or other countries. **onsemi** owns the rights to a number of patents, trademarks, copyrights, trade secrets, and other intellectual property. A listing of **onsemi**'s product/patent coverage may be accessed at www.onsemi.com/site/pdf/Patent-Marking.pdf. **onsemi** reserves the right to make changes at any time to any products or information herein, without notice. The information herein is provided "as-is" and **onsemi** makes no warranty, representation or guarantee regarding the accuracy of the information, product features, availability, functionality, or suitability of its products for any particular purpose, nor does **onsemi** assume any liability arising out of the application or use of any product or circuit, and specifically disclaims any and all liability, including without limitation special, consequential or incidental damages. Buyer is responsible for its products and applications using **onsemi** products, including compliance with all laws, regulations and safety requirements or standards, regardless of any support or applications information provided by **onsemi**. "Typical" parameters which may be provided in **onsemi** data sheets and/or specifications can and do vary in different applications and actual performance may vary over time. All operating parameters, including "Typicals" must be validated for each customer application by customer's technical experts. **onsemi** does not convey any license under any of its intellectual property rights nor the rights of others. **onsemi** products are not designed, intended, or authorized for use as a critical component in life support systems or any FDA Class 3 medical devices or medical devices with a same or similar classification in a foreign jurisdiction or any devices intended for implantation in the human body. Should Buyer purchase or use **onsemi** products for any such unintended or unauthorized application, Buyer shall indemnify and hold **onsemi** and its officers, employees, subsidiaries, affiliates, and distributors harmless against all claims, costs, damages, and expenses, and reasonable attorney fees arising out of, directly or indirectly, any claim of personal injury or death associated with such unintended or unauthorized use, even if such claim alleges that **onsemi** was negligent regarding the design or manufacture of the part. **onsemi** is an Equal Opportunity/Affirmative Action Employer. This literature is subject to all applicable copyright laws and is not for resale in any manner.

ADDITIONAL INFORMATION

TECHNICAL PUBLICATIONS:

Technical Library: www.onsemi.com/design/resources/technical-documentation
onsemi Website: www.onsemi.com

ONLINE SUPPORT: www.onsemi.com/support

For additional information, please contact your local Sales Representative at www.onsemi.com/support/sales