

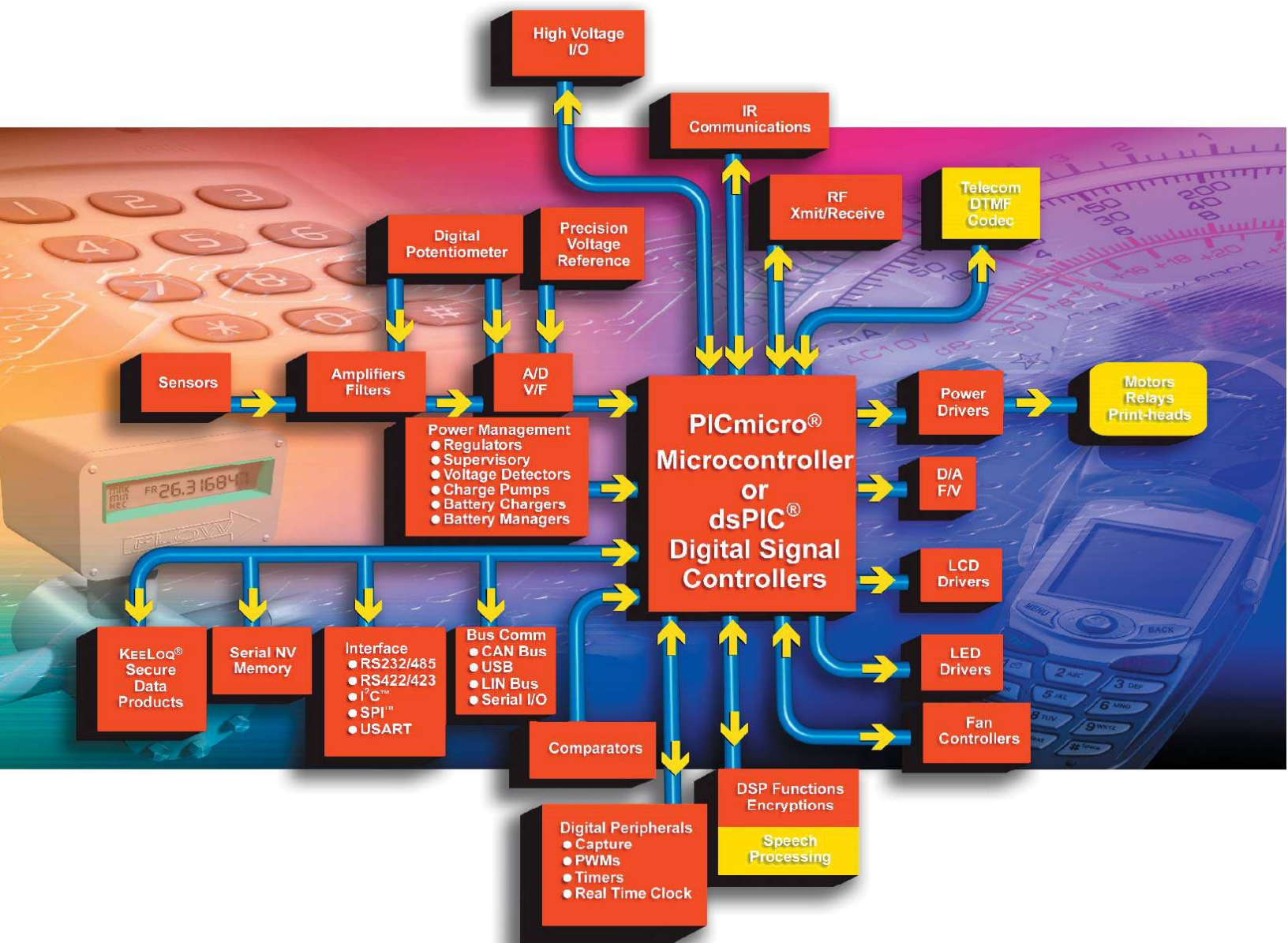

2005 Product Selector Guide



Product Profile

PICmicro® Microcontrollers

Microchip's PICmicro® family of microcontrollers combine high performance, low cost and small package size to offer the best price/performance ratio in the industry. Based on a powerful RISC core, the PICmicro architecture provides users an easy migration path from 6 to 84 pins among all families with little or no code change required. Advanced features available are:

- sophisticated timing peripherals
- embedded analog-to-digital converters (ADCs) and digital-to-analog converters (DACs)
- extended instruction/data memory
- communications peripherals (I²C™/SPI™/USB/CAN and USARTs)
- In-Circuit Serial Programming™ technology (ICSP™)
- memory technology including one-time programmable (OTP), reprogrammable (FLASH) and read-only memory (ROM)
- advanced analog features (PBOR, PLVD, DAC, VREF, Op Amps and PSMC)

dsPIC® Digital Signal Controllers

Building on its leadership position in 8-bit microcontrollers, Microchip now offers a family of 16-bit High Performance Digital Signal Controllers (DSC) that combine in a single core the best features of microcontrollers with the best features of DSPs. These dsPIC DSC devices reach speeds of up to 30 MIPS, are very efficient for C programming, and have Flash, data EEPROM, powerful peripherals and a variety of software libraries that allow high performance embedded solutions to be designed effortlessly and in a short amount of time. With a familiar microcontroller architecture and design environment, these dsPIC DSC devices target applications such as motor control and power conversion, high-speed sensors, speech and audio, internet and modem connectivity, telecom, encryption and automotive applications.

Analog & Interface Products

Microchip offers a wide range of analog and related products:

- *Linear and Mixed-Signal.* ADCs/DACs, digital potentiometers, op amps and comparators.
- *Power Management.* LDO and switching regulators, charge pumps, voltage references, CPU/system supervisors and voltage detectors, battery chargers and power MOSFET drivers.
- *Thermal Management.* Temperature sensors (logic output, voltage output, and serial output), brushless DC fan controllers, and fan fault detectors.
- *Interface.* Peripheral products supporting industry-standard networking protocols like CAN, LIN and infrared (including IrDA® Standard infrared), as well as products that provide embedded system input/output expansion capability.

Secure Data Products

Microchip's KEELoq® family of code hopping devices provides "rock solid" security for remote-keyless-entry (RKE) and authentication applications. Devices using the KEELoq code hopping algorithm combine high security, a small package outline and a very low cost to make this an ideal solution for unidirectional RKE systems. The KEELoq code hopping technology creates a high degree of security using a long code word length together with encryption and synchronization techniques.

Memory Products

- Microchip offers one of the broadest selections of serial EEPROMs in densities from 128 bits to 512 Kbits, with operating voltages down to 1.8V, in all popular bus protocols (I²C™, Microwire and SPI™ compatible). They are available in all standard temperature ranges from -40°C to +125°C and packaged in the world's smallest standard packaging; up to 16 Kbits in 5-lead SOT-23 and up to 256 Kbits in 8-lead MSOP. With high-speed buses, low power consumption, the highest E/W endurance and the longest data retention in the industry, Microchip's serial EEPROMs are used for virtually every application in the automotive, PC, consumer electronics, communications and industrial markets.

rfPIC® Microcontrollers and rfHCS Devices

The rfPIC® family significantly eases the radio frequency (RF) design process while reducing component count and board space. The first devices feature an integrated 315/433 MHz ASK/FSK transmitter. These low-power single-chip RF solutions are the first of many planned devices in the new family which targets RF connectivity for high-volume embedded control applications, such as remote sensing, remote control, toys, security and access control.

Development Systems

Microchip offers a full range of microcontroller development systems, including the MPLAB® ICE 2000 and ICE 9000 in-circuit emulators; MPLAB Integrated Development Environment; MPLAB C18 and C30 Compiler; the MPLAB ICD In-Circuit Debugger, MPLAB PM3 full-featured device programmer; PICSTART® low-cost development system; the PICKit™ 1 Flash Starter Kit, SEEVAL® Serial EEPROM Evaluation Kit and various demonstration boards. Microchip has shipped more than 300,000+ development systems worldwide.

TABLE OF CONTENTS

CURRENT PICmicro® MICROCONTROLLER FAMILY PRODUCTS	5
Baseline 8-bit PICmicro® Microcontroller Family	6
PIC10FXXX	6
PIC12C/FXXX	6
PIC16C/F5X	6
Mid-Range 8-bit PICmicro® Microcontroller Family	7
PIC12FXXX	7
PIC16CXXX	7
PIC16FXXX	8
High Performance 8-bit PICmicro® Microcontroller Family	10
PIC18FXXX Flash MCUs	10
PIC18FXXJXX Flash MCUs	
CURRENT dsPIC® DIGITAL SIGNAL CONTROLLER (DSC) PRODUCTS	23
dsPIC30F Motor Control and Power Conversion Controller Family	23
dsPIC30F General Purpose Controller Family	23
dsPIC30F Sensor Family	24
FOCUSED SOLUTIONS - PICmicro® MICROCONTROLLER FAMILY PRODUCTS	15
Connectivity Solutions	
CAN	15
Ethernet	15
USB	16
rfPIC® Microcontrollers with UHF RF Transmitter, ICSP™	16
rfHCS KEELOQ® Encoders with UHF RF Transmitter	16
UHF RF Receiver	16
LCD Solutions	17
Motor Control Solutions	18
Power-Managed Solutions Featuring nanoWatt Technology	19
MATURE PICmicro® MICROCONTROLLER FAMILY PRODUCTS	20
BATTERY MANAGEMENT FAMILY PRODUCTS	22
Battery Fuel Gauge ICs	22
Switching Battery Chargers	22
RADIO FREQUENCY PRODUCTS	25
PASSIVE - microID® RFID Tagging Devices	25
SECURE DATA PRODUCTS	26
KEELOQ® Encoder Devices	26
KEELOQ® Decoder Devices	26
KEELOQ® Programmable Encoder/Decoder Flash Devices	26

ANALOG/INTERFACE PRODUCTS	27
THERMAL MANAGEMENT PRODUCTS	27
Temperature Sensors	27
Brushless DC Fan Controllers and Fan Fault Detectors	28
POWER MANAGEMENT	29
Voltage References	29
Linear Regulators	30
Switching Regulators	32
PWM	33
Charge Pump DC-to-DC Converters	33
CPU/System Supervisors	34
Voltage Detectors	35
Power MOSFET Drivers	35
Battery Chargers	37
Hot Swap Controllers	37
LINEAR	37
Op Amps	37
High Precision Operational Amplifiers	39
Programmable Gain Amplifiers (PGA)	39
Integrated Devices	40
Comparators	40
MIXED SIGNAL	40
Successive Approximation Register (SAR) A/D Converters	40
Sigma-Delta A/D Converters	41
Dual Slope A/D Converters	41
Binary and BCD A/D Converters	42
Display A/D Converters	42
Digital Potentiometers	43
Frequency-to-Voltage/Voltage-to-Frequency Converters	43
System D/A Converters	43
INTERFACE	44
Controller Area Network (CAN) Products	44
Infrared Products	44
LIN Transceiver Products	45
Serial Peripherals	45
SERIAL ELECTRICALLY ERASABLE PROMS (EEPROM)	46
Microwire Compatible Serial EEPROM Family	46
2-Wire I ² C™ Compatible Serial EEPROM Family	47
ISO Smart Card Family	48
SPI™ Compatible Serial EEPROM Family	48
Identification Products	49

DEVELOPMENT SYSTEMS	50
Development Tools	51
Analog Interface Development Tools	51
PICmicro® Microcontroller Development Tools	51
rfPIC® Microcontroller Development Tools	75
dsPIC® Microcontroller Development Tools	75
Demonstration Boards and Evaluation Kits	78
PICmicro® Demonstration Kits	78
Connectivity Demonstration Kits	78
Mixed Signal Control Demonstration Kits	79
dsPIC® 16-bit MCU/DSP Demonstration Kits	79
dsPIC® 16-bit MCU/DSP Software Tools	79
PowerSmart® Development Systems	80
Memory Evaluation/Developer's Kits	80
KEELOQ® Evaluation Kits	80
RFID Evaluation/Developer's Kits	80
Analog Evaluation/Developer's Kits	81
FUTURE MICROCHIP PRODUCTS	82
BASELINE 8-BIT PICmicro® MICROCONTROLLER (MCU) PRODUCTS	82
PIC12FXXX	82
PIC16FXXX	82
MID-RANGE 8-BIT PICmicro® MICROCONTROLLER FAMILY	82
PIC16FXXX	82
HIGH PERFORMANCE 8-BIT PICmicro® MICROCONTROLLER FAMILY	83
PIC18FXXX	83
BATTERY MANAGEMENT FAMILY PRODUCTS	83
Ethernet Stand-Alone	83
Battery Fuel Gauge ICs	83
dsPIC® DIGITAL SIGNAL CONTROLLER (DSC) PRODUCTS	84
dsPIC30F Motor Control and Power Conversion Controller Family	84
SERIAL ELECTRICALLY ERASABLE PROMS (EEPROM)	84
SPI™ Compatible Serial EEPROM Family	84

ANALOG/INTERFACE PRODUCTS	85
Thermal Management	85
Voltage Output Temperature Sensors	85
Power Management	85
Switching Regulators	85
Linear	85
Operational Amplifiers	85
Linear Gain Blocks	85
Mixed Signal	86
Delta-Sigma A/D Converters	86
Interface	86
Infrared Products	86
Serial Products	86
PIN AND CODE COMPATIBILITY CHART	87
PACKAGE PHOTOS	91
PART NUMBER SUFFIX DESIGNATIONS	93
ABBREVIATIONS	96

PICmicro[®] MICROCONTROLLER FAMILIES

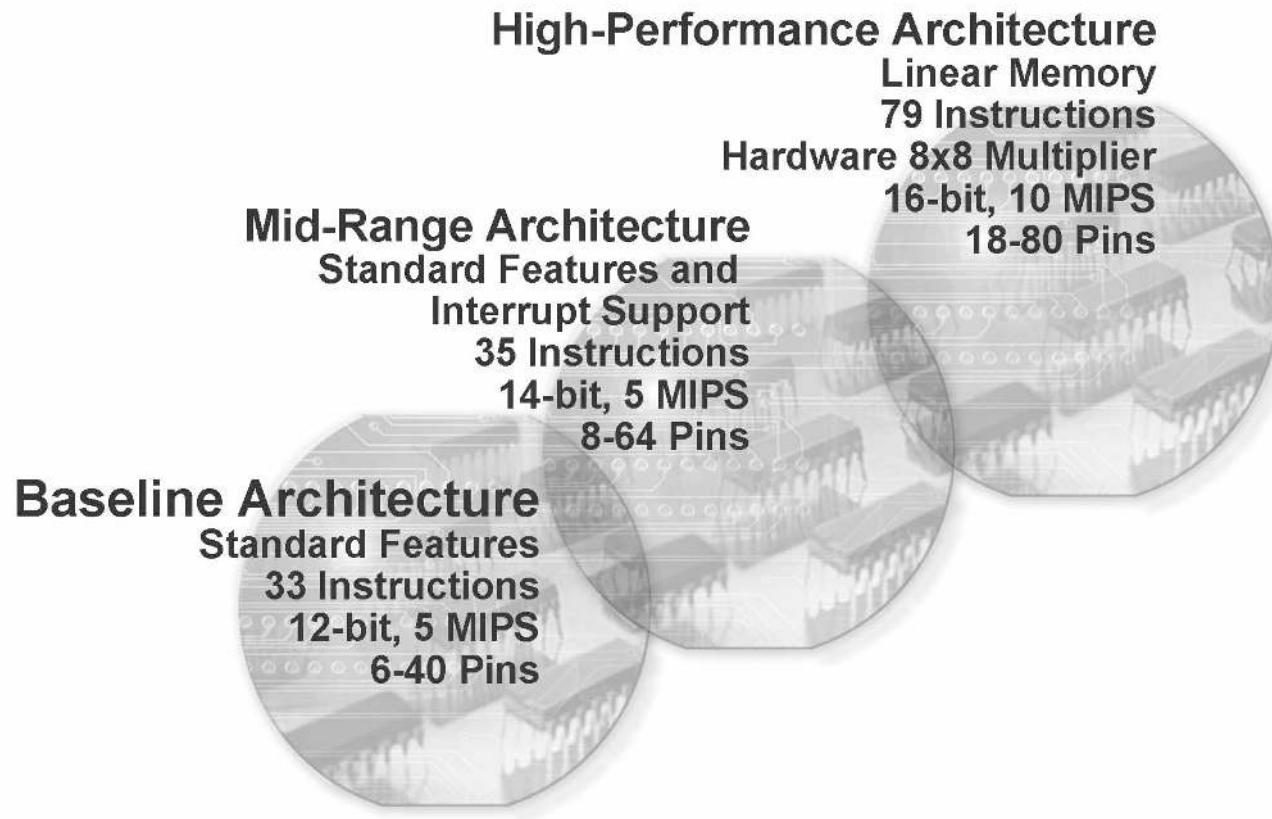

CURRENT 8-BIT PICmicro® MICROCONTROLLER FAMILY PRODUCTS

Baseline 8-Bit PICmicro® Microcontroller Family (12-bit Instruction Set)														
Product	Program Memory Bytes & Type (Words)	RAM Bytes	I/O Pins	Packages	Analog		Digital	Max. Speed MHz	IntOSC	ICSP™	BOR/PBOR/PLVD	ICD # of Breakpoints	Operating Voltage (V)	Other Features
					ADC	Comp.	Timers/WDT							
PIC10FXXX: 1 μs Instruction Execution, 33 Instructions														
PIC10F200	384 StdFI (256)	16	4	6OT, 8P	—	—	1-8 bit, 1-WDT	4	4 MHz	✓	—	1**	2.0 - 5.5	
PIC10F202	768 StdFI (512)	24	4	6OT, 8P	—	—	1-8 bit, 1-WDT	4	4 MHz	✓	—	1**	2.0 - 5.5	
PIC10F204	384 StdFI (256)	16	4	6OT, 8P	—	1	1-8 bit, 1-WDT	4	4 MHz	✓	—	1**	2.0 - 5.5	Bandgap reference
PIC10F206	768 StdFI (512)	24	4	6OT, 8P	—	1	1-8 bit, 1-WDT	4	4 MHz	✓	—	1**	2.0 - 5.5	Bandgap reference
PIC12FXXX: 1 μs Instruction Execution, 33 Instructions, 4 Oscillator Selections														
PIC12F508	768 StdFI (512)	25	6	8P, 8SN, 8MS	—	—	1-8 bit, 1-WDT	4	4 MHz	✓	—	1**	2.0 - 5.5	
PIC12F509	1536 StdFI (1024)	41	6	8P, 8SN, 8MS	—	—	1-8 bit, 1-WDT	4	4 MHz	✓	—	1**	2.0 - 5.5	
PIC16C/F5X: Upwardly Compatible with PIC16C5X/PIC12CXXX, 100-200 ns Instruction Execution, 33/35 Instructions, 4/5 Oscillator Selections														
PIC16C55A	768 OTP (512)	24	20	28P, 28JW, 28SP, 28SO, 28SS	—	—	1-8 bit, 1-WDT	40	—	—	—	—	2.5 - 5.5	
PIC16C56A	1536 OTP (1024)	25	12	18P, 18JW, 18SO, 20SS	—	—	1-8 bit, 1-WDT	40	—	—	—	—	2.5 - 5.5	
PIC16CR56A	1536 ROM (1024)	25	12	18P, 18SO, 20SS	—	—	1-8 bit, 1-WDT	20	—	—	—	—	2.5 - 5.5	
PIC16C58B	3072 OTP (2048)	73	12	18P, 18JW, 18SO, 20SS	—	—	1-8 bit, 1-WDT	40	—	—	—	—	2.5 - 5.5	
PIC16CR58B	3072 ROM (2048)	73	12	18P, 18SO, 20SS	—	—	1-8 bit, 1-WDT	20	—	—	—	—	2.5 - 5.5	
PIC16HV540	768 OTP (512)	25	12	18P, 18JW, 18SO, 20SS	—	—	1-8 bit, 1-WDT	20	—	—	BOR	—	3.5 - 15	8 high-voltage (15V) I/Os, 4 deep stack, 5 I/Os with wake-up-on-change
PIC16F505	1536 StdFI (1024)	72	12	14P, 14JW, 14SL	—	—	1-8 bit, 1-WDT	20	4 MHz	✓	—	1**	2.0 - 5.5	
PIC16F54	768 StdFI (512)	25	12	18P, 18SO, 20SS	—	—	1-8 bit, 1-WDT	20	—	✓	—	—	2.0 - 5.5	
PIC16F57	3072 StdFI (2048)	72	20	28P, 28SO, 28SS, 28SP	—	—	1-8 bit, 1-WDT	20	—	✓	—	—	2.0 - 5.5	
PIC16F59	3072 StdFI (2048)	134	32	40P, 44PT	—	—	1-8 bit, 1-WDT	20	—	✓	—	—	2.0 - 5.5	

*Contact Microchip Technology for availability date.

** Requires ICD specific device with header module – refer to Development Tools. Abbreviations are found on the last page of the Selector Guide.

Mid-Range 8-Bit PICmicro® Microcontroller Family (14-bit Instruction Set)

Product	Program Memory Bytes & Type (Words)	EEPROM Data Memory Bytes	RAM Bytes	I/O Pins	Packages	Analog		Digital		Max. Speed MHz	IntOSC	BOR/PBOR/PLVD	ICD # of Breakpoints	CCP/ECCP	nW	Other Features
						ADC Ch	Comp.	Timers/WDT	Serial I/O							
PIC12FXXX: Upwardly Compatible with PIC12CXXX, 200 ns – 1 µs Instruction Execution, 35 Instructions, 4/5 Oscillator Selections, ICSP™																
PIC12F629	1792 StdFI (1024)	128	64	6	8P, 8SN, 8MF	—	1	1-8 bit, 1-16 bit, 1-WDT	—	20	4 MHz	BOR	1**	—	—	
PIC12F635	1792 StdFI (1024)	128	64	6	8P, 8SN, 8MF	—	1	1-8 bit, 1-16 bit, 1-WDT	—	20	8 MHz	BOR/PLVD	1**	—	✓	KEELOQ® hardware peripheral
PIC12F675	1792 StdFI (1024)	128	64	6	8P, 8SN, 8MF	4x10-bit	1	1-8 bit, 1-16 bit, 1-WDT	—	20	4 MHz	BOR	1**	—	—	
PIC12F683	3584 StdFI (2048)	256	128	6	8P, 8SN, 8MF	4x10-bit	1	1-16 bit, 2-8 bit, 1-WDT	—	20	8 MHz	BOR	1**	1/0	✓	
PIC16CXXX: Upwardly Compatible with PIC16C5X/PIC12CXXX, 4-12 Interrupts, 100-200 ns Instruction Executions, 35 Instructions, 4/5 Oscillator Selections, ICSP™ (except ROM)																
PIC14000	7168 OTP (4096)	—	192	20	28SP, 28SO, 28SS, 28JW	8 SLAC	2	1-8 bit, 1-16 bit, 1-WDT	I ² C™/SMB	20	4 MHz	—	—	—	—	Temperature Sensor, Program Reference Generator
PIC16C432	3584 OTP (2048)	—	128	12	20SS, 20P, 20JW	—	2	1-8 bit, 1-WDT	LIN	20	—	BOR	—	—	—	LIN XCVR, 18V/40 mA
PIC16C433	3584 OTP (2048)	—	128	6	18SO, 18P, 18JW	4x8-bit	—	1-8 bit, 1-WDT	LIN	10	4 MHz	—	—	—	—	LIN XCVR, 18V/40 mA
PIC16C554	896 OTP (512)	—	80	13	18P, 18SO, 18JW, 20SS	—	—	1-8 bit, 1-WDT	—	20	—	—	—	—	—	
PIC16C558	3584 OTP (2048)	—	128	13	18P, 18SO, 18JW, 20SS	—	—	1-8 bit, 1-WDT	—	20	—	—	—	—	—	
PIC16C62B	3584 OTP (2048)	—	128	22	28SP, 28SO, 28SS, 28JW, 28ML	—	—	1-16 bit, 2-8 bit, 1-WDT	I ² C/SPI™	20	—	BOR	—	1/0	—	
PIC16C620A	896 OTP (512)	—	96	13	18P, 18SO, 18JW, 20SS	—	2	1-8 bit, 1-WDT	—	40	—	BOR	—	—	—	
PIC16CR620A	896 OTP (512)	—	96	13	18P, 18SO, 20SS	—	2	1-8 bit, 1-WDT	—	20	—	BOR	—	—	—	
PIC16C621A	1792 OTP (1024)	—	96	13	18P, 18SO, 18JW, 20SS	—	2	1-8 bit, 1-WDT	—	40	—	BOR	—	—	—	
PIC16C622A	3584 OTP (2048)	—	128	13	18P, 18SO, 18JW, 20SS	—	2	1-8 bit, 1-WDT	—	40	—	BOR	—	—	—	
PIC16C63A	7168 OTP (4096)	—	192	22	28SP, 28SO, 28SS, 28JW, 28ML	—	—	1-16 bit, 2-8 bit, 1-WDT	USART, I ² C/SPI	20	—	BOR	—	2/0	—	
PIC16CR63	7168 OTP (4096)	—	192	22	28SP, 28SO, 28SS	—	—	1-16 bit, 2-8 bit, 1-WDT	USART, I ² C/SPI	20	—	BOR	—	2/0	—	
PIC16C65B	7168 OTP (4096)	—	192	33	40P, 40JW, 44L, 44PQ, 44PT	—	—	1-16 bit, 2-8 bit, 1-WDT	USART, I ² C/SPI	20	—	BOR	—	2/0	—	PSP
PIC16CR65	7168 OTP (4096)	—	192	33	40P, 44L, 44PQ, 44PT	—	—	1-16 bit, 2-8 bit, 1-WDT	USART, I ² C/SPI	20	—	BOR	—	2/0	—	PSP
PIC16C717	3584 OTP (2048)	—	256	16	18P, 18SO, 18JW, 20SS	6x10-bit	—	1-16 bit, 2-8 bit, 1-WDT	M ² C/SPI	20	4 MHz	PBOR/PLVD	—	0/1	—	
PIC16CR72	3584 OTP (2048)	—	128	22	28SP, 28SO, 28SS	5x8-bit	—	1-16 bit, 2-8 bit, 1-WDT	I ² C/SPI	20	—	BOR	—	1/0	—	
PIC16C745	14336 OTP (8192)	—	256	22	28SP, 28SO, 28JW	5x8-bit	—	1-16 bit, 2-8 bit, 1-WDT	USART, low-speed USB	24	—	BOR	—	2/0	—	USB 1.1, 64 bytes dual port RAM

*Contact Microchip Technology for availability date.

** Requires ICD specific device with header module – refer to Development Tools. Abbreviations are found on the last page of the Selector Guide.

Mid-Range 8-Bit PICmicro [®] Microcontroller Family (14-bit Instruction Set)																
Product	Program Memory Bytes & Type (Words)	EEPROM Data Memory Bytes	RAM Bytes	I/O Pins	Packages	Analog		Digital		Max. Speed MHz	IntOSC	BOR/PBOR/PLVD	ICD # of Breakpoints	CCP/ECCP	nW	Other Features
						ADC Ch	Comp.	Timers/WDT	Serial I/O							
PIC16CXXX: Upwardly Compatible with PIC16C5X/PIC12CXXX, 4-12 Interrupts, 100-200 ns Instruction Executions, 35 Instructions, 4/5 Oscillator Selections, ICSP™ (except ROM) (continued)																
PIC16C765	14336 OTP (8192)	—	256	33	40P, 40JW, 44L, 44PT	8x8-bit	—	1-16 bit, 2-8 bit, 1-WDT	USART, low-speed USB	24	—	BOR	—	2/0	—	USB 1.1, 64 bytes dual port RAM, PSP
PIC16C770	3584 OTP (2048)	—	256	16	20P, 20SO, 20JW, 20SS	6x12-bit	—	1-16 bit, 2-8 bit, 1-WDT	MI ² C/SPI	20	4 MHz	PBOR/PLVD	—	0/1	—	
PIC16C771	7168 OTP (4096)	—	256	16	20P, 20SO, 20JW, 20SS	6x12-bit	—	1-16 bit, 2-8 bit, 1-WDT	MI ² C/SPI	20	4 MHz	PBOR/PLVD	—	0/1	—	
PIC16C773	7168 OTP (4096)	—	256	22	28SP, 28SO, 28SS, 28JW	6x12-bit	—	1-16 bit, 2-8 bit, 1-WDT	AUSART, MI ² C/SPI	20	—	PBOR/PLVD	—	2/0	—	
PIC16C774	7168 OTP (4096)	—	256	33	40P, 40JW, 44L, 44PQ, 44PT	10x12-bit	—	1-16 bit, 2-8 bit, 1-WDT	AUSART, MI ² C/SPI	20	—	PBOR/PLVD	—	2/0	—	PSP
PIC16C781	1792 OTP (1024)	—	128	16	20P, 20SO, 20SS, 20JW	8x8-bit	2	1-16 bit, 2-8 bit, 1-WDT	—	20	4 MHz	PBOR	—	—	—	Op Amp, PSMC, DAC
PIC16C782	3584 OTP (2048)	—	128	16	20P, 20SO, 20SS, 20JW	8x8-bit	2	1-16 bit, 2-8 bit, 1-WDT	—	20	4 MHz	PBOR/PLVD	—	—	—	Op Amp, PSMC, DAC
PIC16C925	7168 OTP (4096)	—	176	52	68CL, 68L, 64PT	5x10-bit	—	1-16 bit, 2-8 bit, 1-WDT	I ² C/SPI	20	—	BOR	—	1/0	—	LCD module, static, 1/2, 1/3, 1/4 multiplex
PIC16C926	14336 OTP (8192)	—	336	52	68CL, 68L, 64PT	5x10-bit	—	1-16 bit, 2-8 bit, 1-WDT	I ² C/SPI	20	—	BOR	—	1/0	—	LCD module, static, 1/2, 1/3, 1/4 multiplex
PIC16FXXX: Migration to PIC16CXXX/PIC16C5X/PIC12CXXX, 17 Interrupts, 200 ns Instruction Executions, 33/35 Instructions, 4 Oscillator Selections, ICSP™ (except ROM)																
PIC16F627A	1792 StdFI (1024)	128	224	16	18P, 18SO, 20SS, 28ML	—	2	1-16 bit, 2-8 bit, 1-WDT	AUSART	20	4 MHz	BOR	1**	1/0	✓	
PIC16F628A	3584 StdFI (2048)	128	224	16	18P, 18SO, 20SS, 28ML	—	2	1-16 bit, 2-8 bit, 1-WDT	AUSART	20	4 MHz	BOR	1**	1/0	✓	
PIC16F648A	7168 StdFI (4096)	256	256	16	18P, 18SO, 20SS, 28ML	—	2	1-16 bit, 2-8 bit, 1-WDT	AUSART	20	4 MHz	BOR	1**	1/0	✓	
PIC16F630	1792 StdFI (1024)	128	64	12	14P, 14SL, 14ST	—	1	1-8-bit, 1-16 bit, 1-WDT	—	20	4 MHz	BOR	1**	—	—	
PIC16F636	3584 StdFI (2048)	256	128	12	14P, 14SL, 14ST	—	2	1-8 bit, 1-16 bit, 1-WDT	—	20	8 MHz	BOR/PLVD	1**	—	✓	KEELOQ [®] hardware peripheral
NEW PIC16F639*	3584 StdFI (2048)	256	128	12	20P, 20SO, 20SS	—	2	1-16 bit, 1-8 bit, 1-WDT	—	20	8 MHz	BOR	1**	—	✓	Transponder Analog Front End, KEELOQ [®] hardware peripheral
PIC16F676	1792 StdFI (1024)	128	64	12	14P, 14SL, 14ST	8x10-bit	1	1-8 bit, 1-16 bit, 1-WDT	—	20	4 MHz	BOR	1**	—	—	
PIC16F684	3584 StdFI (2048)	256	128	12	14P, 14SL, 14ST	8x10-bit	2	1-16 bit, 2-8 bit, 1-WDT	—	20	8 MHz	BOR	1**	0/1	✓	
NEW PIC16F685*	7168 StdFI (4096)	256	256	18	20P, 20SO, 20SS	12 x 10-bit	2	1-16 bit, 2-8 bit, 1-WDT	—	20	8 MHz	BOR	1**	0/1	✓	
NEW PIC16F687*	3584 StdFI (2048)	256	128	18	20P, 20SO, 20SS	12 x 10-bit	2	1-16 bit, 1-8 bit, 1-WDT	EUSART, I ² C/SPI	20	8 MHz	BOR	1**	—	✓	
PIC16F688	7168 StdFI (4096)	256	256	12	14P, 14SL, 14ST	8x10-bit	2	1-8 bit, 1-16 bit, 1-WDT	EUSART	20	8 MHz	BOR	1**	—	✓	
NEW PIC16F689*	7168 StdFI (4096)	256	256	18	20P, 20SO, 20SS	12x10-bit	2	1-16 bit, 1-8 bit, 1-WDT	EUSART, I ² C/SPI	20	8 MHz	BOR	1**	—	✓	

*Contact Microchip Technology for availability date.

** Requires ICD specific device with header module – refer to Development Tools.

Abbreviations are found on the last page of the Selector Guide.

Mid-Range 8-Bit PICmicro® Microcontroller Family (14-bit Instruction Set)

Product	Program Memory Bytes & Type (Words)	EEPROM Data Memory Bytes	RAM Bytes	I/O Pins	Packages	Analog		Digital		Max. Speed MHz	IntOSC	BOR/PBOR/PLVD	ICD # of Breakpoints	CCP/ECCP	nW	Other Features
						ADC Ch	Comp.	Timers/WDT	Serial I/O							
PIC16FXXX: Migration to PIC16CXXX/PIC16C5X/PIC12CXXX, 17 Interrupts, 200 ns Instruction Execution, 33/35 Instructions, 4 Oscillator Selections, ICSP™ (except ROM) (continued)																
PIC16F690*	7168 StdFI (4096)	256	256	18	20P, 20SO, 20SS	12x10-bit	2	1-16 bit, 2-8 bit, 1-WDT	EUSART, I ² C, SPI	20	8 MHz	BOR	1**	0/1	✓	
PIC16F716	3584 StdFI (2048)	—	128	13	18P, 18SO, 20SS	4x8-bit	—	1-16 bit, 2-8 bit, 1-WDT	—	20	—	BOR	1**	0/1	—	
PIC16F72	3584 StdFI (2048)	—	128	22	28SP, 28SO, 28SS, 28ML	5x8-bit	—	1-16 bit, 2-8 bit, 1-WDT	I ² C/SPI	20	—	BOR	—	1/0	—	
PIC16F73	7168 StdFI (4096)	—	192	22	28SP, 28SO, 28SS, 28ML	5x8-bit	—	1-16 bit, 2-8 bit, 1-WDT	USART, I ² C/SPI	20	—	BOR	—	2/0	—	
PIC16F737	7168 StdFI (4096)	—	368	25	28SP, 28SO, 28SS, 28ML	11x10-bit	2	1-16 bit, 2-8 bit, 1-WDT	AUSART, MI ² C/SPI	20	8 MHz	PBOR/PLVD	1	3/0	✓	
PIC16F74	7168 StdFI (4096)	—	192	33	40P, 44ML, 44L, 44PT	8x8-bit	—	1-16 bit, 2-8 bit, 1-WDT	USART, I ² C/SPI	20	—	BOR	—	2/0	—	PSP
PIC16F747	7168 StdFI (4096)	—	368	36	40P, 44PT, 44ML	14x10-bit	2	1-16 bit, 2-8 bit, 1-WDT	AUSART, MI ² C/SPI	20	8 MHz	PBOR/PLVD	1	3/0	✓	PSP
PIC16F76	14336 StdFI (8192)	—	368	22	28SP, 28SO, 28SS, 28ML	5x8-bit	—	1-16 bit, 2-8 bit, 1-WDT	USART, I ² C/SPI	20	—	BOR	—	2/0	—	
PIC16F767	14336 StdFI (8192)	—	368	25	28SP, 28SO, 28SS, 28ML	11x10-bit	2	1-16 bit, 2-8 bit, 1-WDT	AUSART, MI ² C/SPI	20	8 MHz	PBOR/PLVD	1	3/0	✓	
PIC16F77	14336 StdFI (8192)	—	368	33	40P, 44ML, 44L, 44PT	8x8-bit	—	1-16 bit, 2-8 bit, 1-WDT	USART, I ² C/SPI	20	—	BOR	—	2/0	—	PSP
PIC16F777	14336 StdFI (8192)	—	368	36	40P, 44PT, 44ML	14x10-bit	2	1-16 bit, 2-8 bit, 1-WDT	AUSART, MI ² C/SPI	20	8 MHz	PBOR/PLVD	1	3/0	✓	PSP
PIC16F785*	3584 StdFI (2048)	256	128	18	20P, 20SO, 20SS	12x10-bit	2	1-16 bit, 2-8 bit, 1-WDT	—	20	8 MHz	BOR	1**	1/0	✓	2 phase PWM, 2 x OpAmp, VREF
PIC16F818	1792 EnhFI (1024)	128	128	16	18P, 18SO, 20SS, 28ML	5x10-bit	—	1-16 bit, 2-8 bit, 1-WDT	I ² C/SPI	20	8 MHz	BOR	1	1/0	✓	
PIC16F819	3584 EnhFI (2048)	256	256	16	18P, 18SO, 20SS, 28ML	5x10-bit	—	1-16 bit, 2-8 bit, 1-WDT	I ² C/SPI	20	8 MHz	BOR	1	1/0	✓	
PIC16F84A	1792 StdFI (1024)	64	68	13	18P, 18SO, 20SS	—	—	1-8 bit, 1-WDT	—	20	—	—	—	—	—	
PIC16F87	7168 EnhFI (4096)	256	368	16	18P, 18SO, 20SS, 28ML	—	2	1-16 bit, 2-8 bit, 1-WDT	AUSART, I ² C/SPI	20	8 MHz	BOR	1	1/0	✓	
PIC16F870	3584 EnhFI (2048)	64	128	22	28SP, 28SO, 28SS	5x10-bit	—	1-16 bit, 2-8 bit, 1-WDT	AUSART	20	—	BOR	1	1/0	—	
PIC16F871	3584 EnhFI (2048)	64	128	33	40P, 44L, 44PT	8x10-bit	—	1-16 bit, 2-8 bit, 1-WDT	AUSART	20	—	BOR	1	1/0	—	PSP
PIC16F872	3584 EnhFI (2048)	64	128	22	28SP, 28SO, 28SS	5x10-bit	—	1-16 bit, 2-8 bit, 1-WDT	MI ² C/SPI	20	—	BOR	1	1/0	—	
PIC16F873A	7168 EnhFI (4096)	128	192	22	28SP, 28SO, 28SS, 28ML	5x10-bit	2	1-16 bit, 2-8 bit, 1-WDT	AUSART, MI ² C/SPI	20	—	BOR	1	2/0	—	
PIC16F874A	7168 EnhFI (4096)	128	192	33	40P, 44ML, 44L, 44PT	8x10-bit	2	1-16 bit, 2-8 bit, 1-WDT	AUSART, MI ² C/SPI	20	—	BOR	1	2/0	—	PSP

*Contact Microchip Technology for availability date.

** Requires ICD specific device with header module – refer to Development Tools. Abbreviations are found on the last page of the Selector Guide.

Mid-Range 8-Bit PICmicro® Microcontroller Family (14-bit Instruction Set)

Product	Program Memory Bytes & Type (Words)	EEPROM Data Memory Bytes	RAM Bytes	I/O Pins	Packages	Analog		Digital		Max. Speed MHz	IntOSC	BOR/PBOR/PLVD	ICD # of Breakpoints	CCP/ECCP	nW	Other Features
						ADC Ch	Comp.	Timers/WDT	Serial I/O							
PIC16FXXX: Migration to PIC16CXXX/PIC16C5X/PIC12CXXX, 17 Interrupts, 200 ns Instruction Execution, 33/35 Instructions, 4 Oscillator Selections, ICSP™ (except ROM) (continued)																
PIC16F876A	14336 EnhFI (8192)	256	368	22	28SP, 28SO, 28SS, 28ML	5x10-bit	2	1-16 bit, 2-8 bit, 1-WDT	AUSART, MI ² C/SPI	20	—	BOR	1	2/0	—	
PIC16F877A	14336 EnhFI (8192)	256	368	33	40P, 44ML, 44L, 44PT	8x10-bit	2	1-16 bit, 2-8 bit, 1-WDT	AUSART, MI ² C/SPI	20	—	BOR	1	2/0	—	PSP
PIC16F88	7168 EnhFI (4096)	256	368	16	18P, 18SO, 20SS, 28ML	7x10-bit	2	1-16 bit, 2-8 bit, 1-WDT	AUSART, I ² C/SPI	20	8 MHz	BOR	1	1/0	✓	
NEW PIC16F913*	7168 StdFI (4096)	256	256	25	28P, 28SO, 28SS, 28ML	5x10-bit	2	2-8 bit, 1-16 bit	AUSART, I ² C/SPI	20	8 MHz	BOR/PLVD	1	1/0	✓	Integrated LCD control modules with 60 segments
NEW PIC16F914*	7168 StdFI (4096)	256	256	36	40P, 44PT, 44ML	8x10-bit	2	2-8 bit, 1-16 bit	AUSART, I ² C/SPI	20	8 MHz	BOR/PLVD	1	2/0	✓	Integrated LCD control modules with 96 segments
NEW PIC16F916*	14336 StdFI (8192)	256	352	25	28P, 28SO, 28SS, 28ML	5x10-bit	2	2-8 bit, 1-16 bit	AUSART, I ² C/SPI	20	8 MHz	BOR/PLVD	1	1/0	✓	Integrated LCD control modules with 60 segments
NEW PIC16F917*	14336 StdFI (8192)	256	352	36	40P, 44PT, 44ML	8x10-bit	2	2-8 bit, 1-16 bit	AUSART, I ² C/SPI	20	8 MHz	BOR/PLVD	1	2/0	✓	Integrated LCD control modules with 96 segments

*Contact Microchip Technology for availability date.

** Requires ICD specific device with header module – refer to Development Tools. Abbreviations are found on the last page of the Selector Guide.

High Performance 8-Bit PICmicro® Microcontroller Family (16-bit Instruction Set)

Product	Program Memory Bytes & Type (Words)	EEPROM Data Memory Bytes	RAM Bytes	I/O Pins	Packages	Analog		Digital		Max. Speed MHz	IntOSC	BOR/PBOR/PLVD	ICD # of Breakpoints	CCP/ECCP	nW	Other Features
						ADC Ch	Comp.	Timers/WDT	Serial I/O							
PIC18FXXX Flash MCUs: Upwardly Compatible with PIC18CXXX/PIC17C7XX/PIC16CXX/PIC16C5X/PIC12CXXX, 77 Instructions, C Compiler Efficient Instruction Set, 10 MIPS, V_{DD} = 2.0 - 5.5V (except ROM)																
PIC18C601	ROM-less	—	1536	26	64PT, 68L	8x10-bit	—	3-16 bit, 1-8 bit, 1-WDT	AUSART, MI ² C/SPI	25	—	—	—	2/0	—	256KB EMA, Bootloader RAM
PIC18C801	ROM-less	—	1536	37	80PT, 84L	12x10-bit	—	3-16 bit, 1-8 bit, 1-WDT	AUSART, MI ² C/SPI	25	—	—	—	2/0	—	2MB EMA, Bootloader RAM
PIC18F1220	4096 EnhFI (2048)	256	256	16	18P, 18SO, 20SS, 28ML	7x10-bit	—	3-16 bit, 1-8 bit, 1-WDT	EUSART	40	8 MHz	PBOR/PLVD	1	0/1	✓	
PIC18F1320	8192 EnhFI (4096)	256	256	16	18P, 18SO, 20SS, 28ML	7x10-bit	—	3-16 bit, 1-8 bit, 1-WDT	EUSART	40	8 MHz	PBOR/PLVD	1	0/1	✓	
PIC18F2220	4096 EnhFI (2048)	256	512	25	28SP, 28SO	10x10-bit	2	3-16 bit, 1-8 bit, 1-WDT	AUSART, MI ² C/SPI	40	8 MHz	PBOR/PLVD	1	2/0	✓	
PIC18F2320	8192 EnhFI (4096)	256	512	25	28SP, 28SO	10x10-bit	2	3-16 bit, 1-8 bit, 1-WDT	AUSART, MI ² C/SPI	40	8 MHz	PBOR/PLVD	1	2/0	✓	
PIC18F2331	8192 EnhFI (4096)	256	768	24	28SP, 28SO, 28MM	5x10-bit, 200 ksps	—	3-16 bit, 1-8 bit, 1-WDT	EUSART, I ² C/SPI	40	8 MHz	PBOR/PLVD	1	2/0	✓	6 channel 14-bit Motor Control PWMs, 2-ch Quadrature Encoder

*Contact Microchip Technology for availability date.

Abbreviations are found on the last page of the Selector Guide.

High Performance 8-Bit PICmicro® Microcontroller Family (16-bit Instruction Set)

Product	Program Memory Bytes & Type (Words)	EEPROM Data Memory Bytes	RAM Bytes	I/O Pins	Packages	Analog		Digital		Max. Speed MHz	IntOSC	BOR/PBOR/PLVD	ICD # of Breakpoints	CCP/ECCP	nW	Other Features	
						ADC Ch	Comp.	Timers/WDT	Serial I/O								
PIC18FXXX Flash MCUs: Upwardly Compatible with PIC18CXXX/PIC17C7XX/PIC16CXX/PIC16C5X/PIC12CXXX, 77 Instructions, C Compiler Efficient Instruction Set, 10 MIPS, V_{DD} = 2.0 - 5.5V (except ROM) (continued)																	
PIC18F2410	16384 StdFI (8192)	—	768	25	28SP, 28SO, 28ML	10x10-bit 100 kspcs	2	3-16 bit, 1-8 bit, 1-WDT	EUSART, MI ² C/SPI	40	8 MHz	PBOR/ PLVD	3	2/0	✓		
PIC18F2420	16384 EnhFI (8192)	256	768	25	28SP, 28SO, 28ML	10x10-bit 100 kspcs	2	3-16 bit, 1-8 bit, 1-WDT	EUSART, MI ² C/SPI	40	8 MHz	PBOR/ PLVD	3	2/0	✓		
PIC18F2431	16384 EnhFI (8192)	256	768	24	28SP, 28SO, 28MM	5x10-bit, 200 kspcs	—	3-16 bit, 1-8 bit, 1-WDT	EUSART, I ² C/SPI	40	8 MHz	PBOR/ PLVD	1	2/0	✓	6 channel 14-bit Motor Control PWMs, 2-ch Quadrature Encoder	
NEW	PIC18F2455	24576 EnhFI (12288)	256	2048	23	28SP, 28SO	11x10-bit 100 kspcs	2	3-16 bit, 1-8 bit, 1-WDT	USB 2.0, MI ² C/SPI, EUSART	48	8 MHz	PBOR/ PLVD	3	2/0	✓	Full-speed USB 2.0 Compliant
NEW	PIC18F2480	16384 EnhFI (8192)	256	768	25	28SP, 28SO, 28ML	8x10-bit 100 kspcs	—	3-16 bit, 1-8 bit, 1-WDT	CAN 2.0B, MI ² C/SPI, EUSART	40	8 MHz	PBOR/ PLVD	3	1/0	✓	ECAN
	PIC18F2510	32768 StdFI (16384)	—	1536	25	28SP, 28SO, 28ML	10x10-bit 100 kspcs	2	3-16 bit, 1-8 bit, 1-WDT	EUSART, MI ² C/SPI	40	8 MHz	PBOR/ PLVD	3	2/0	✓	
	PIC18F2520	32768 EnhFI (16384)	256	1536	25	28SP, 28SO, 28ML	10x10-bit 100 kspcs	2	3-16 bit, 1-8 bit, 1-WDT	EUSART, MI ² C/SPI	40	8 MHz	PBOR/ PLVD	3	2/0	✓	
	PIC18F2515	49152 StdFI (24576)	—	3968	25	28SP, 28SO	10x10-bit 100 kspcs	2	3-16 bit, 1-8 bit, 1-WDT	EUSART, MI ² C/SPI	40	8 MHz	PBOR/ PLVD	3	2/0	✓	
	PIC18F2525	49152 EnhFI (24576)	1024	3968	25	28SP, 28SO	10x10-bit 100 kspcs	2	3-16 bit, 1-8 bit, 1-WDT	EUSART, MI ² C/SPI	40	8 MHz	PBOR/ PLVD	3	2/0	✓	
NEW	PIC18F2550	32768 EnhFI (16384)	256	2048	23	28SP, 28SO	11x10-bit 100 kspcs	2	3-16 bit, 1-8 bit, 1-WDT	USB 2.0, MI ² C/SPI, EUSART	48	8 MHz	PBOR/ PLVD	3	2/0	✓	Full-speed USB 2.0 Compliant
NEW	PIC18F2580	32768 EnhFI (16384)	256	1536	25	28SP, 28SO, 28ML	8x10-bit 100 kspcs	—	3-16 bit, 1-8 bit, 1-WDT	CAN 2.0B, MI ² C/SPI, EUSART	40	8 MHz	PBOR/ PLVD	3	1/0	✓	ECAN
	PIC18F2585	49152 EnhFI (24576)	1024	3328	25	28SP, 28SO	8x10-bit 100 kspcs	—	3-16 bit, 1-8 bit, 1-WDT	EUSART, MI ² C/SPI	40	8 MHz	PBOR/ PLVD	3	1/0	✓	ECAN
	PIC18F2610	65536 StdFI (32768)	—	3968	25	28SP, 28SO	10x10-bit 100 kspcs	2	3-16 bit, 1-8 bit, 1-WDT	EUSART, MI ² C/SPI	40	8 MHz	PBOR/ PLVD	3	2/0	✓	
	PIC18F2620	65536 EnhFI (32768)	1024	3968	25	28SP, 28SO	10x10-bit 100 kspcs	2	3-16 bit, 1-8 bit, 1-WDT	EUSART, MI ² C/SPI	40	8 MHz	PBOR/ PLVD	3	2/0	✓	
	PIC18F2680	65536 EnhFI (32768)	1024	3328	25	28SP, 28SO	8x10-bit 100 kspcs	—	3-16 bit, 1-8 bit, 1-WDT	CAN 2.0B, MI ² C/SPI, EUSART	40	8 MHz	PBOR/ PLVD	3	1/0	✓	ECAN
	PIC18F4220	4096 EnhFI (2048)	256	512	36	40P, 44ML, 44PT	13x10-bit	2	3-16 bit, 1-8 bit, 1-WDT	AUSART, MI ² C/SPI	40	8 MHz	PBOR/ PLVD	1	1/1	✓	PSP
	PIC18F4320	8192 EnhFI (4096)	256	512	36	40P, 44ML, 44PT	13x10-bit	2	3-16 bit, 1-8 bit, 1-WDT	AUSART, MI ² C/SPI	40	8 MHz	PBOR/ PLVD	1	1/1	✓	PSP

*Contact Microchip Technology for availability date.
Abbreviations are found on the last page of the Selector Guide.

High Performance 8-Bit PICmicro® Microcontroller Family (16-bit Instruction Set)																	
Product	Program Memory Bytes & Type (Words)	EEPROM Data Memory Bytes	RAM Bytes	I/O Pins	Packages	Analog		Digital		Max. Speed MHz	IntOSC	BOR/PBOR/PLVD	ICD # of Breakpoints	CCP/ECCP	nW	Other Features	
						ADC Ch	Comp.	Timers/WDT	Serial I/O								
PIC18FXXX Flash MCUs (x16): Upwardly Compatible with PIC18CXXX/PIC17C7XX/PIC16CXX/PIC16C5X/PIC12CXXX, 77 Instructions, C Compiler Efficient Instruction Set, 10 MIPS, VDD = 2.0 - 5.5V (except ROM) (continued)																	
PIC18F4331	8192 EnhFI (4096)	256	768	36	40P, 44ML, 44PT	9x10-bit 200 ksps	—	3-16 bit, 1-8 bit, 1-WDT	EUSART, I ² C/SPI	40	8 MHz	PBOR/PLVD	1	2/0	✓	8 channel 14-bit Motor Control PWMs, 2-ch Quadrature Encoder	
PIC18F4410	16384 StdFI (8192)	—	768	36	40P, 44ML, 44PT	13x10-bit 100 ksps	2	3-16 bit, 1-8 bit, 1-WDT	EUSART, MI ² C/SPI	40	8 MHz	PBOR/PLVD	3	1/1	✓	PSP	
PIC18F4420	16384 EnhFI (8192)	256	768	36	40P, 44ML, 44PT	13x10-bit 100 ksps	2	3-16 bit, 1-8 bit, 1-WDT	EUSART, MI ² C/SPI	40	8 MHz	PBOR/PLVD	3	1/1	✓	PSP	
PIC18F4431	16384 EnhFI (8192)	256	768	36	40P, 44ML, 44PT	9x10-bit 200 ksps	—	3-16 bit, 1-8 bit, 1-WDT	EUSART, I ² C/SPI	40	8 MHz	PBOR/PLVD	1	2/0	✓	8 channel 14-bit Motor Control PWMs, 2-ch Quadrature Encoder	
NEW	PIC18F4455	24576 EnhFI (12288)	256	2048	34	40P, 44ML, 44PT	13x10-bit 100 ksps	2	3-16 bit, 1-8 bit, 1-WDT	USB 2.0, MI ² C/SPI, EUSART	48	8 MHz	PBOR/PLVD	3	1/1	✓	Full-speed USB 2.0 Compliant, Streaming Port
NEW	PIC18F4480	16384 EnhFI (8192)	256	768	36	40P, 44ML, 44PT	11x10-bit 100 ksps	2	3-16 bit, 1-8 bit, 1-WDT	CAN 2.0B, MI ² C/SPI, EUSART	40	8 MHz	PBOR/PLVD	3	1/1	✓	ECAN
	PIC18F4510	32768 StdFI (16384)	—	1536	36	40P, 44ML, 44PT	13x10-bit 100 ksps	2	3-16 bit, 1-8 bit, 1-WDT	EUSART, MI ² C/SPI	40	8 MHz	PBOR/PLVD	3	1/1	✓	PSP
	PIC18F4520	32768 EnhFI (16384)	256	1536	36	40P, 44ML, 44PT	13x10-bit 100 ksps	2	3-16 bit, 1-8 bit, 1-WDT	EUSART, MI ² C/SPI	40	8 MHz	PBOR/PLVD	3	1/1	✓	PSP
	PIC18F4515	49152 StdFI (24576)	—	3968	36	40P, 44ML, 44PT	13x10-bit 100 ksps	2	3-16 bit, 1-8 bit, 1-WDT	EUSART, MI ² C/SPI	40	8 MHz	PBOR/PLVD	3	1/1	✓	PSP
	PIC18F4525	49152 EnhFI (24576)	1024	3968	36	40P, 44ML, 44PT	13x10-bit 100 ksps	2	3-16 bit, 1-8 bit, 1-WDT	EUSART, MI ² C/SPI	40	8 MHz	PBOR/PLVD	3	1/1	✓	PSP
NEW	PIC18F4580	32768 EnhFI (16384)	256	1536	36	40P, 44ML, 44PT	11x10-bit 100 ksps	2	3-16 bit, 1-8 bit, 1-WDT	CAN 2.0B, MI ² C/SPI, EUSART	40	8 MHz	PBOR/PLVD	3	1/1	✓	ECAN
NEW	PIC18F4550	32768 EnhFI (16384)	256	2048	34	40P, 44ML, 44PT	13x10-bit 100 ksps	2	3-16 bit, 1-8 bit, 1-WDT	USB 2.0, MI ² C/SPI, EUSART	48	8 MHz	PBOR/PLVD	3	1/1	✓	Full-speed USB 2.0 Compliant, Streaming Port
	PIC18F4585	49152 EnhFI (24576)	1024	3328	36	40P, 44ML, 44PT	11x10-bit 100 ksps	2	3-16 bit, 1-8 bit, 1-WDT	CAN 2.0B, MI ² C/SPI, EUSART	40	8 MHz	PBOR/PLVD	3	1/1	✓	ECAN
	PIC18F4610	65536 StdFI (32768)	—	3968	36	40P, 44ML, 44PT	13x10-bit 100 ksps	2	3-16 bit, 1-8 bit, 1-WDT	EUSART, MI ² C/SPI	40	8 MHz	PBOR/PLVD	3	1/1	✓	PSP
	PIC18F4620	65536 EnhFI (32768)	1024	3968	36	40P, 44ML, 44PT	13x10-bit 100 ksps	2	3-16 bit, 1-8 bit, 1-WDT	EUSART, MI ² C/SPI	40	8 MHz	PBOR/PLVD	3	1/1	✓	PSP
	PIC18F4680	65536 EnhFI (32768)	1024	3328	36	40P, 44ML, 44PT	11x10-bit 100 ksps	2	3-16 bit, 1-8 bit, 1-WDT	CAN 2.0B, MI ² C/SPI, EUSART	40	8 MHz	PBOR/PLVD	3	1/1	✓	ECAN
	PIC18F6310	8192 StdFI (4096)	—	768	54	64PT	12x10-bit 100 ksps	2	3-16 bit, 1-8 bit, 1-WDT	MI ² C/SPI, EUSART, AUSART	40	8 MHz	PBOR/PLVD	3	3/0	✓	EMA

*Contact Microchip Technology for availability date.
Abbreviations are found on the last page of the Selector Guide.

High Performance 8-Bit PICmicro® Microcontroller Family (16-bit Instruction Set)

Product	Program Memory Bytes & Type (Words)	EEPROM Data Memory Bytes	RAM Bytes	I/O Pins	Packages	Analog		Digital		Max. Speed MHz	IntOSC	BOR/PBOR/PLVD	ICD # of Breakpoints	CCP/ECCP	nW	Other Features
						ADC Ch	Comp.	Timers/WDT	Serial I/O							
PIC18FXXX Flash MCUs (x16): Upwardly Compatible with PIC18CXXX/PIC17C7XX/PIC16CXX/PIC16C5X/PIC12CXXX, 77 Instructions, C Compiler Efficient Instruction Set, 10 MIPS, V_{DD} = 2.0 - 5.5V (except ROM) (continued)																
PIC18F6410	16384 StdFI (8192)	—	768	54	64PT	12x10-bit 100 ksps	2	3-16 bit, 1-8 bit, 1-WDT	MI ² C/SPI, EUSART, AUSART	40	8 MHz	PBOR/ PLVD	3	3/0	✓	EMA
PIC18F6390	8192 StdFI (4096)	—	768	50	64PT	12x10-bit 100 ksps	2	3-16 bit, 1-8 bit, 1-WDT	MI ² C/SPI, EUSART, AUSART	40	8 MHz	PBOR/ PLVD	3	2/0	✓	LCD: up to 128 Segments
PIC18F6490	16384 StdFI (8192)	—	768	50	64PT	12x10-bit 100 ksps	2	3-16 bit, 1-8 bit, 1-WDT	MI ² C/SPI, EUSART, AUSART	40	8 MHz	PBOR/ PLVD	3	2/0	✓	LCD: up to 128 Segments
PIC18F6520	32768 EnhFI (16384)	1024	2048	52	64PT	12x10-bit	2	3-16 bit, 2-8 bit, 1-WDT	2x AUSART, MI ² C/SPI	40	—	PBOR/ PLVD	1	5/0	—	PSP
PIC18F6525	49152 EnhFI (24576)	1024	3840	53	64PT	12x10-bit	2	3-16 bit, 2-8 bit, 1-WDT	2x EUSART, MI ² C/SPI	40	—	PBOR/ PLVD	1	2/3	—	PSP
NEW PIC18F6527*	49152 EnhFI (24576)	1024	3936	54	64PT	12x10-bit 100 ksps	2	3-16 bit, 2-8 bit, 1-WDT	2x EUSART, 2x MI ² C/SPI	40	8 MHz	PBOR/ PLVD	3	2/3	✓	PSP
PIC18F6585	49152 EnhFI (24576)	1024	3328	53	64PT, 68L	12x10-bit	2	3-16 bit, 1-8 bit, 1-WDT	EUSART, MI ² C/SPI, CAN 2.0B	40	—	PBOR/ PLVD	1	1/1	—	ECAN
PIC18F6621	65536 EnhFI (32768)	1024	3840	53	64PT	12x10-bit	2	3-16 bit, 2-8 bit, 1-WDT	2x EUSART, MI ² C/SPI	40	—	PBOR/ PLVD	1	2/3	—	PSP
NEW PIC18F6622*	65536 EnhFI (32768)	1024	3936	54	64PT	12x10-bit 100 ksps	2	3-16 bit, 2-8 bit, 1-WDT	2x EUSART, 2x MI ² C/SPI	40	8 MHz	PBOR/ PLVD	3	2/3	✓	PSP
NEW PIC18F6627	98304 EnhFI (49152)	1024	3936	54	64PT	12x10-bit 100 ksps	2	3-16 bit, 2-8 bit, 1-WDT	2x EUSART, 2x MI ² C/SPI	40	8 MHz	PBOR/ PLVD	3	2/3	✓	PSP
PIC18F6680	65536 EnhFI (32768)	1024	3328	53	64PT, 68L	12x10-bit	2	3-16 bit, 1-8 bit, 1-WDT	EUSART, MI ² C/SPI, CAN 2.0B	40	—	PBOR/ PLVD	1	1/1	—	ECAN
PIC18F6720	131072 EnhFI (65536)	1024	3840	52	64PT	12x10-bit	2	3-16 bit, 2-8 bit, 1-WDT	2x AUSART, MI ² C/SPI	25	—	PBOR/ PLVD	1	5/0	—	PSP
NEW PIC18F6722	131072 EnhFI (65536)	1024	3936	54	64PT	12x10-bit 100 ksps	2	3-16 bit, 2-8 bit, 1-WDT	2x EUSART, 2x MI ² C/SPI	40	8 MHz	PBOR/ PLVD	3	2/3	✓	PSP
PIC18F8310	8192 StdFI (4096)	—	768	70	80PT	12x10-bit 100 ksps	2	3-16 bit, 1-8 bit, 1-WDT	MI ² C/SPI, EUSART, AUSART	40	8 MHz	PBOR/ PLVD	3	3/0	✓	EMA
PIC18F8410	16384 StdFI (8192)	—	768	70	80PT	12x10-bit 100 ksps	2	3-16 bit, 2-8 bit, 1-WDT	MI ² C/SPI, EUSART, AUSART	40	8 MHz	PBOR/ PLVD	3	3/0	✓	EMA
PIC18F8390	8192 StdFI (4096)	—	768	66	80PT	12x10-bit 100 ksps	2	3-16 bit, 1-8 bit, 1-WDT	MI ² C/SPI, EUSART, AUSART	40	8 MHz	PBOR/ PLVD	3	2/0	✓	LCD: up to 192 Segments

*Contact Microchip Technology for availability date.

Abbreviations are found on the last page of the Selector Guide.

High Performance 8-Bit PICmicro® Microcontroller Family (16-bit Instruction Set)

Product	Program Memory Bytes & Type (Words)	EEPROM Data Memory Bytes	RAM Bytes	I/O Pins	Packages	Analog		Digital		Max. Speed MHz	IntOSC	BOR/PBOR/PLVD	ICD # of Breakpoints	CCP/ECCP	nW	Other Features
						ADC Ch	Comp.	Timers/WDT	Serial I/O							
PIC18FXXX Flash MCUs: Upwardly Compatible with PIC18CXXX/PIC17C7XX/PIC16CXX/PIC16C5X/PIC12CXXX, 77 Instructions, C Compiler Efficient Instruction Set, 10 MIPS, V_{DD} = 2.0 - 5.5V (except ROM) (continued)																
PIC18F8490	16384 StdFI (8192)	—	768	66	80PT	12x10-bit 100 ksps	2	3-16 bit, 2-8 bit, 1-WDT	MI ² C/SPI, EUSART, AUSART	40	8 MHz	PBOR/ PLVD	3	2/0	✓	LCD: up to 192 Segments
PIC18F8520	32768 EnhFI (16384)	1024	2048	68	80PT	16x10-bit	2	2-8 bit, 3-16 bit, 1-WDT	2x AUSART, MI ² C/SPI	40	—	PBOR/ PLVD	1	5/0	—	PSP, EMA
PIC18F8525	49152 EnhFI (24576)	1024	3840	69	80PT	16x10-bit	2	3-16 bit, 2-8 bit, 1-WDT	2x EUSART, MI ² C/SPI	40	—	PBOR/ PLVD	1	2/3	—	PSP, EMA
NEW PIC18F8527*	49152 EnhFI (24576)	1024	3936	70	80PT	16x10-bit 100 ksps	2	3-16 bit, 2-8 bit, 1-WDT	2x EUSART, 2x MI ² C/SPI	40	8 MHz	PBOR/ PLVD	3	2/3	3	PSP, EMA
PIC18F8585	49152 EnhFI (24576)	1024	3328	69	80PT	16x10-bit	2	3-16 bit, 1-8 bit, 1-WDT	EUSART, MI ² C/SPI, CAN2.0B	40	—	PBOR/ PLVD	1	1/1	—	ECAN, EMA
PIC18F8621	65536 EnhFI (32768)	1024	3840	69	80PT	16x10-bit	2	3-16 bit, 2-8 bit, 1-WDT	2x EUSART, MI ² C/SPI	40	—	PBOR/ PLVD	1	2/3	—	PSP, EMA
NEW PIC18F8622*	65536 EnhFI (32768)	1024	3936	70	80PT	16x10-bit 100 ksps	2	3-16 bit, 2-8 bit, 1-WDT	2x EUSART, 2x MI ² C/SPI	40	8 MHz	PBOR/ PLVD	3	2/3	3	PSP, EMA
NEW PIC18F8627	98304 EnhFI (49152)	1024	3936	70	80PT	16x10-bit 100 ksps	2	3-16 bit, 2-8 bit, 1-WDT	2x EUSART, 2x MI ² C/SPI	40	8 MHz	PBOR/ PLVD	3	2/3	3	PSP, EMA
PIC18F8680	65536 EnhFI (32768)	1024	3328	69	80PT	16x10-bit	2	3-16 bit, 1-8 bit, 1-WDT	EUSART, MI ² C/SPI, CAN2.0B	40	—	PBOR/ PLVD	1	1/1	—	ECAN, EMA
PIC18F8720	131072 EnhFI (65536)	1024	3840	68	80PT	16x10-bit	2	3-16 bit, 2-8 bit, 1-WDT	2x AUSART, MI ² C/SPI	25	—	PBOR/ PLVD	1	5/0	—	PSP, EMA
NEW PIC18F8722	131072 EnhFI (65536)	1024	3936	70	80PT	16x10-bit 100 ksps	2	3-16 bit, 2-8 bit, 1-WDT	2x EUSART, 2x MI ² C/SPI	40	8 MHz	PBOR/ PLVD	3	2/3	3	PSP, EMA
PIC18FXXJXX Flash MCUs: Upwardly Compatible with PIC18CXXX/PIC17C7XX/PIC16CXX/PIC16C5X/PIC12CXXX, 77 Instructions, C Compiler Efficient Instruction Set, 10 MIPS, V_{DD} = 2.0 - 3.6V																
NEW PIC18F66J15*	98304 StdFI (49152)	—	3936	51	64PT	11x10-bit 100 ksps	2	3-16 bit, 2-8 bit, 1-WDT	2x EUSART, 2x MI ² C/SPI	40	32 kHz	BOR	3	2/3	✓	PSP
NEW PIC18F67J10*	131072 StdFL (65536)	—	3936	51	64PT	11x10-bit 100 ksps	2	3-16 bit, 2-8 bit, 1-WDT	2x EUSART, 2x MI ² C/SPI	40	32 kHz	BOR	3	2/3	✓	PSP
NEW PIC18F86J15*	98304 StdFL (49152)	—	3936	67	80PT	15x10-bit 100 ksps	2	3-16 bit, 2-8 bit, 1-WDT	2x EUSART, 2x MI ² C/SPI	40	32 kHz	BOR	3	2/3	✓	PSP, EMA
NEW PIC18F87J10*	131072 StdFI (65536)	—	3936	67	80PT	15x10-bit 100 ksps	2	3-16 bit, 2-8 bit, 1-WDT	2x EUSART, 2x MI ² C/SPI	40	32 kHz	BOR	3	2/3	✓	PSP, EMA

*Contact Microchip Technology for availability date.

Abbreviations are found on the last page of the Selector Guide.

CURRENT dsPIC® DIGITAL SIGNAL CONTROLLER (DSC) PRODUCTS

Product	Program (FLASH) KBytes	Memory (FLASH) KWords	EE Bytes	SRAM Bytes	I/O Pins (max.)	Packages	A/D 12-bit 100 KSPS	A/D 10-bit 500 KSPS	Timer 16-bit	Input Cap	Output Comp/ Std PWM	Motor Control PWM	Quad Enc.	UART	SPI™	I ² C™	CAN	Codec Interface
dsPIC30F Motor Control and Power Conversion Family																		
dsPIC30F2010	12	4	1024	512	20	28SO, 28SP, 28MM	—	6 ch	3	4	2	6	✓	1	1	1	—	—
dsPIC30F3010	24	8	1024	1024	20	28SO, 28SP, 44ML (8x8)	—	6 ch	5	4	2	6	✓	1	1	1	—	—
dsPIC30F4012	48	16	1024	2048	20	28SO, 28SP, 44ML (8x8)	—	6 ch	5	4	2	6	✓	1	1	1	1	—
dsPIC30F3011	24	8	1024	1024	30	40P, 44PT, 44ML (8x8)	—	9 ch	5	4	4	6	✓	2	1	1	—	—
dsPIC30F4011	48	16	1024	2048	30	40P, 44PT, 44ML (8x8)	—	6 ch	5	4	4	6	✓	2	1	1	1	—
dsPIC30F6010	144	48	4096	8192	68	80PF	—	16 ch	5	8	8	8	✓	2	2	1	2	—
dsPIC30F General Purpose Family																		
dsPIC30F3014	24	8	1024	2048	30	40P, 44PT, 44ML (8x8)	13 ch	—	3	2	2	No	No	2	1	1	—	—
dsPIC30F4013	48	16	1024	2048	30	40P, 44PT, 44ML (8x8)	13 ch	—	5	4	4	No	No	2	1	1	1	AC97, I ² S
dsPIC30F5011	66	22	1024	4096	52	64PT	16 ch	—	5	8	8	No	No	2	2	1	2	AC97, I ² S
dsPIC30F6011	132	44	2048	6144	52	64PF	16 ch	—	5	8	8	No	No	2	2	1	2	—
dsPIC30F6012	144	48	4096	8192	52	64PF	16 ch	—	5	8	8	No	No	2	2	1	2	AC97, I ² S
dsPIC30F5013	66	22	1024	4096	68	80PT	16 ch	—	5	8	8	No	No	2	2	1	2	AC97, I ² S
dsPIC30F6013	132	44	2048	6144	68	80PF	16 ch	—	5	8	8	No	No	2	2	1	2	—
dsPIC30F6014	144	48	4096	8192	68	80PF	16 ch	—	5	8	8	No	No	2	2	1	2	AC97, I ² S

Abbreviations are found on the last page of the Selector Guide.

Product	Program (FLASH) KBytes	Memory (FLASH) KWords	EE Bytes	SRAM Bytes	I/O Pins (max.)	Packages	A/D 12-bit 100 KSPS	A/D 10-bit 500 KSPS	Timer 16-bit	Input Cap	Output Comp/ Std PWM	Motor Control PWM	Quad Enc.	UART	SPI™	I ² C™	CAN	Codec Interface	
dsPIC30F Sensor Family																			
NEW	dsPIC30F2011	12	4	0	1024	12	18SO, 18P, 28ML (6x6)	8 ch	—	3	2	2	No	No	1	1	1	—	—
NEW	dsPIC30F3012	24	8	1024	2048	12	18SO, 18P, 44ML (8x8)	8 ch	—	3	2	2	No	No	1	1	1	—	—
NEW	dsPIC30F2012	12	4	0	1024	12	28SO, 28SP, 28ML (6x6)	10 ch	—	3	2	2	No	No	1	1	1	—	—
NEW	dsPIC30F3013	24	8	1024	2048	12	28SO, 28SP, 44ML (8x8)	10 ch	—	3	2	2	No	No	2	1	1	—	—

Abbreviations are found on the last page of the Selector Guide.

FOCUSED SOLUTIONS

PICmicro[®] and dsPIC[®] DSC MICROCONTROLLER FAMILY PRODUCTS

Product	Program Memory Bytes & Type (Words)	EEPROM Data Memory Bytes	RAM Bytes	I/O Pins	Packages	Analog Peripherals	Digital Peripherals	Max. Speed MHz	ICD # of Breakpoints	Function-Specific Features					Development Boards
										ISO-16845 Tested	Transmit Buffers	Receive Buffers	Configurable RX/TX	Acceptance Filters/Mask	
CAN Solutions															
PIC18F2480	16384 EnhFI (8192)	256	768	25	28SP, 28SO, 28ML	ADC	EUSART, CCP	40	3	Planned	3	2	6	16/2	DM163011 PICDEM™ CAN-LIN 2
PIC18F2580	32768 EnhFI (16384)	256	1536	25	28SP, 28SO, 28ML	ADC	EUSART, CCP	40	3	Planned	3	2	6	16/2	DM163011 PICDEM™ CAN-LIN 2
PIC18F2585	49152 EnhFI (24576)	1024	3328	25	28SP, 28SO	ADC	EUSART, CCP	40	3	Planned	3	2	6	16/2	DM163011 PICDEM™ CAN-LIN 2
PIC18F2680	65536 EnhFI (32768)	1024	3328	25	28SP, 28SO	ADC	EUSART, CCP	40	3	Planned	3	2	6	16/2	DM163011 PICDEM™ CAN-LIN 2
PIC18F4480	16384 EnhFI (8192)	256	768	36	40P, 44PT, 44ML	ADC/Comp	EUSART, CCP/ECCP	40	3	Planned	3	2	6	16/2	DM163011 PICDEM™ CAN-LIN 2
PIC18F4580	32768 EnhFI (16384)	256	1536	36	40P, 44PT, 44ML	ADC/Comp	EUSART, CCP/ECCP	40	3	Planned	3	2	6	16/2	DM163011 PICDEM™ CAN-LIN 2
PIC18F4585	49152 EnhFI (24576)	1024	3328	36	40P, 44PT, 44ML	ADC/Comp	EUSART, CCP/ECCP	40	3	Planned	3	2	6	16/2	DM163011 PICDEM™ CAN-LIN 2
PIC18F4680	65536 EnhFI (32768)	1024	3328	36	40P, 44PT, 44ML	ADC/Comp	EUSART, CCP/ECCP	40	3	Planned	3	2	6	16/2	DM163011 PICDEM™ CAN-LIN 2
PIC18F6585	49152 EnhFI (24576)	1024	3328	53	64PT, 68L	ADC/Comp	EUSART, CCP/ECCP	40	1	Yes	3	2	6	16/2	DM163015 PICDEM™ CAN-LIN 3
PIC18F6680	65536 EnhFI (32768)	1024	3328	53	64PT, 68L	ADC/Comp	EUSART, CCP/ECCP	40	1	Yes	3	2	6	16/2	DM163015 PICDEM™ CAN-LIN 3
PIC18F8585	49152 EnhFI (24576)	1024	3328	69	80PT	ADC/Comp	EUSART, CCP/ECCP	40	1	Yes	3	2	6	16/2	DM163015 PICDEM™ CAN-LIN 3
PIC18F8680	65536 EnhFI (32768)	1024	3328	69	80PT	ADC/Comp	EUSART, CCP/ECCP	40	1	Yes	3	2	6	16/2	DM163015 PICDEM™ CAN-LIN 3

Refer to Design pages on www.microchip.com for further details.
Abbreviations are found on the last page of the Selector Guide.

Product	Program Memory Bytes & Type (Words)	EEPROM Data Memory	RAM Bytes	I/O Pins	Packages	Analog Peripherals	Digital Peripherals	Max. Speed MHz	ICD # of Breakpoints	Function-Specific Features					Development Boards
										IEEE.802.3 Complaint	MAC	PHY	TX/RX Buffer (bytes)	Ethernet Voltage Range (V)	
Ethernet Solutions - Integrated															
PIC18F66J60*	16384 EnhFI (8192)	—	3808	39	64PT	ADC/Comp	EUSART, CCP/ECCP	42	3	Yes	Yes	10 BASE-T	8192	3.14 to 3.45	
PIC18F66J65*	32768 EnhFI (16384)	—	3808	39	64PT	ADC/Comp	EUSART, CCP/ECCP	42	3	Yes	Yes	10 BASE-T	8192	3.14 to 3.45	
PIC18F67J60*	49152 EnhFI (24576)	—	3808	39	64PT	ADC/Comp	EUSART, CCP/ECCP	42	3	Yes	Yes	10 BASE-T	8192	3.14 to 3.45	
PIC18F86J60*	65536 EnhFI (32768)	—	3808	55	80PT	ADC/Comp	EUSART, CCP/ECCP	42	3	Yes	Yes	10 BASE-T	8192	3.14 to 3.45	
PIC18F86J65*	16384 EnhFI (8192)	—	3808	55	80PT	ADC/Comp	EUSART, CCP/ECCP	42	3	Yes	Yes	10 BASE-T	8192	3.14 to 3.45	

*Contact Microchip Technology Inc. for availability.
Abbreviations are found on the last page of the Selector Guide.

**PICmicro[®] and dsPIC[®] DSC
MCU Products**

Product	Program Memory Bytes & Type (Words)	EEPROM Data Memory	RAM Bytes	I/O Pins	Packages	Analog Peripherals	Digital Peripherals	Max. Speed MHz	ICD-# of Breakpoints	Function-Specific Features					Development Boards	
										IEEE.802.3 Compliant	MAC	PHY	TX/RX Buffer (bytes)	Ethernet Voltage Range (V)		
Ethernet Solutions - Integrated (continued)																
PIC18F87J60*	32768 EnhFI (16384)	—	3808	55	80PT	ADC/Comp	EUSART, CCP/ECCP	42	3	Yes	Yes	10 BASE-T	8192	3.14 to 3.45		
PIC18F96J60*	49152 EnhFI (24576)	—	3808	70	100PT	ADC/Comp	EUSART, CCP/ECCP	42	3	Yes	Yes	10 BASE-T	8192	3.14 to 3.45		
PIC18F96J65*	65536 EnhFI (32768)	—	3808	70	100PT	ADC/Comp	EUSART, CCP/ECCP	42	3	Yes	Yes	10 BASE-T	8192	3.14 to 3.45		
PIC18F97J60*	49152 EnhFI (24576)	—	3808	70	100PT	ADC/Comp	EUSART, CCP/ECCP	42	3	Yes	Yes	10 BASE-T	8192	3.14 to 3.45		

*Contact Microchip Technology Inc. for availability.
Abbreviations are found on the last page of the Selector Guide.

Product	MAC	PHY	TX/RX Dual Port RAM Buffer	Interrupts	LEDs	Operating Voltage (V)	Temp. Range (°C)	Max. Speed MHz	Serial	Features	Package	Development Boards
Ethernet Solutions - Stand-Alone												
ENC28J60*	Yes	10 BASE-T	8KB	2	2	3.3	-40 to +85	25	SPI	Loop back test modes, auto-polarity	28SO, 28SS, 28ML	

*Contact Microchip Technology Inc. for availability.
Abbreviations are found on the last page of the Selector Guide.

NEW

Product	Program Memory Bytes & Type (Words)	EEPROM Data Memory Bytes	RAM Bytes	I/O Pins	Packages	Analog Peripherals	Digital Peripherals	Max. Speed MHz	ICD # of Breakpoints	Function-Specific Features					Development Boards	
										Compliant	Speed	# of Endpoints	USB Buffer (bytes)	Streaming Port		
USB Solutions																
PIC16C745	14336 OTP (8192)	—	256	22	28SP, 28SO, 28JW	ADC	UART	24	—	USB 1.1	Low-speed (1.5Mbit/s)	16	64	—	DM163010, PICDEM™ USB	
PIC16C765	14336 OTP (8192)	—	256	33	40P, 40JW, 44L, 44PT	ADC	UART	24	—	USB 1.1	Low-speed (1.5Mbit/s)	16	64	—	DM163010, PICDEM™ USB	
PIC18F2455	24576 EnhFI (12288)	256	2048	24	28SP, 28SO, 28ML	ADC/Comp	EUSART, MI ² C/SPI	48	3	USB 2.0	Full-speed (12Mbit/s)	16	1024	—	DM163025 PICDEM™ FS-USB	
PIC18F2550	32768 EnhFI (16384)	256	2048	24	28SP, 28SO, 28ML	ADC/Comp	EUSART, MI ² C/SPI	48	3	USB 2.0	Full-speed (12Mbit/s)	16	1024	—	DM163025 PICDEM™ FS-USB	
PIC18F4455	24576 EnhFI (12288)	256	2048	36	40P, 44PT, 44ML	ADC/Comp	EUSART, MI ² C/SPI	48	3	USB 2.0	Full-speed (12Mbit/s)	16	1024	Yes	DM163025 PICDEM™ FS-USB	
PIC18F4550	32768 EnhFI (16384)	256	2048	36	40P, 44PT, 44ML	ADC/Comp	EUSART, MI ² C/SPI	48	3	USB 2.0	Full-speed (12Mbit/s)	16	1024	Yes	DM163025 PICDEM™ FS-USB	

Refer to Design pages on www.microchip.com for further details.
Abbreviations are found on the last page of the Selector Guide.

ACTIVE RF Solutions
rfPIC® Microcontrollers with UHF RF Transmitter, ICSP™

Product	Program Memory Bytes & Type (Words)	EEPROM Data Memory Bytes	RAM Bytes	I/O Pins	Packages	Analog Peripherals	Digital Peripherals	Max. Speed (MHz)	Function-Specific Specifications					Development Boards
									Modulation	Data Rate (kbps)	Output Power (dBm)	Operating Voltage (V)	Frequency Range (MHz)	
rfPIC12C509AF	1536 OTP (1024)	—	41	6	20JW, 20SS	—	1-8 bit Timer, WDT	4	FSK, ASK	40	2	2.5-5.5	310-440	
rfPIC12C509AG	1536 OTP (1024)	—	41	6	18JW, 18SO	—	1-8 bit Timer, WDT	4	ASK	40	2	2.5-5.5	310-440	
rfPIC12F675F	1792 StdFI (1024)	128	64	6	20SS	4x10-bit A/D, Comp	1-8 bit, 1-16 bit Timer, WDT	20	FSK, ASK	40	10	2.0-5.5	380-450	DV164102, rfPIC® Development Kit
rfPIC12F675H	1792 StdFI (1024)	128	64	6	20SS	4x10-bit A/D, Comp	1-8 bit, 1-16 bit Timer, WDT	20	FSK, ASK	40	10	2.0-5.5	850-930	DV164102, rfPIC® Development Kit
rfPIC12F675K	1792 StdFI (1024)	128	64	6	20SS	4x10-bit A/D, Comp	1-8 bit, 1-16 bit Timer, WDT	20	FSK, ASK	40	10	2.0-5.5	290-350	DV164102, rfPIC® Development Kit

rfHCS KEELoq® Encoders with UHF RF Transmitter

Product	Transmission Code Length Bits	Code Hopping Bits	Programmable Encryption Key Bits	Packages	Protocols	Function Codes	Tunable OSC	CRC	Function-Specific Specifications				Development Boards
									Modulation	Output Power (dBm)	Operating Voltage (V)	Frequency Range (MHz)	
rfHCS362F	69	32	2 x 64	20SS	PWM, Manchester	4 x 15	✓	✓	FSK, ASK	2	2.2-5.5	310-440	DM303006, KEELoq® Evaluation Kit II
rfHCS362G	69	32	2 x 64	18SO	PWM, Manchester	4 x 15	✓	✓	ASK	2	2.2-5.5	310-440	DM303006, KEELoq® Evaluation Kit II

UHF RF Receiver

Product	Modulation	Data Rate (kbps)	Frequency Range (MHz)	Sensitivity dBm (FSK)	IF Frequency Range (MHz)	Operating Voltage (V)	Package	Development Boards
rfRXD0420	ASK, FSK, FM	80	300-450	-111	0.455-21.4	2.5-5.5	32LQ	DV164102, rfPIC® Development Kit
rfRXD0920	ASK, FSK, FM	80	800-930	-109	0.455-21.4	2.5-5.5	32LQ	DV164102, rfPIC® Development Kit

Refer to Design pages on www.microchip.com for further details.
Abbreviations are found on the last page of the Selector Guide.

**PICmicro[®] and dsPIC[®] DSC
MCU Products**

Product	Program Memory Bytes & Type (Words)	EEPROM Data Memory Bytes	RAM Bytes	I/O Pins	Packages	Analog Peripherals	Digital Peripherals	Max. Speed MHz	ICD # of Breakpoints	LCD Function-Specific Features					Development Boards
										COMxSegment = # Segments	Drive in Sleep	Software Configurable Driver Pins	Direct Drive	Intl. Charge Pump	
LCD Solutions															
PIC16C925	7168 OTP (4096)	—	176	52	64PT, 68CL, 68L	ADC	I ² C/SPI	20	—	4x29 (116)	Yes	No	Yes	Yes	DM163003, PICDEM™ 3 LCD
PIC16C926	14336 OTP (8192)	—	336	52	64PT, 68CL, 68L	ADC	I ² C/SPI	20	—	4x29 (116)	Yes	No	Yes	Yes	DM163003, PICDEM™ 3 LCD
PIC16F913*	7168 EnhFI (4096)	256	256	25	28P, 28SO, 28SS, 28ML	ADC/Comp	AUSART, I ² C/SPI	20	1	4x15 (60)	Yes	Yes	Yes	No	
PIC16F914*	7168 EnhFI (4096)	256	256	36	40P, 44PT, 44ML	ADC/Comp	AUSART, I ² C/SPI	20	1	4x24 (96)	Yes	Yes	Yes	No	
PIC16F916*	14336 EnhFI (8192)	256	352	25	28P, 28SO, 28SS, 28ML	ADC/Comp	AUSART, I ² C/SPI	20	1	4x15 (60)	Yes	Yes	Yes	No	
PIC16F917*	14336 EnhFI (8192)	256	352	36	40P, 44PT, 44ML	ADC/Comp	AUSART, I ² C/SPI	20	1	4x24 (96)	Yes	Yes	Yes	No	
PIC18F6390	8192 StdFI (4096)	—	768	50	64PT	ADC/Comp	EUSART, AUSART, MI ² C/SPI	40	3	4x32 (128)	Yes	Yes	Yes	No	DM163028, PICDEM™ LCD Demo Board
PIC18F6490	16384 StdFI (8192)	—	768	50	64PT	ADC/Comp	EUSART, AUSART, MI ² C/SPI	40	3	4x32 (128)	Yes	Yes	Yes	No	DM163028, PICDEM™ LCD Demo Board
PIC18F8390	8192 StdFI (4096)	—	768	66	80PT	ADC/Comp	EUSART, AUSART, MI ² C/SPI	40	3	4x48 (192)	Yes	Yes	Yes	No	DM163028, PICDEM™ LCD Demo Board
PIC18F8490	16384 StdFI (8192)	—	768	66	80PT	ADC/Comp	EUSART, AUSART, MI ² C/SPI	40	3	4x48 (192)	Yes	Yes	Yes	No	DM163028, PICDEM™ LCD Demo Board

*Contact Microchip Technology Inc. for availability.
Refer to Design pages on www.microchip.com for further details.
Abbreviations are found on the last page of the Selector Guide.

Product	Program Memory Bytes & Type (Words)	EEPROM Data Memory Bytes	RAM Bytes	I/O Pins	Packages	Analog Peripherals	Digital Peripherals	Max. Speed MHz	ICD # of Breakpoints	Function-Specific Features					Development Boards
										Timers	Input Capture	Output Comp/Std PWM	Motor Control PWM	Quadrature Encoder	
Motor Control Solutions															
PIC12F683	3584 StdFI (2048)	256	128	6	8P, 8SN, 8MF	ADC/Comp	—	20	1	1-16 bit, 2-8 bit, WDT	1	1x10 bit	—	—	PICKit™ 1
PIC16F684	3584 EnhFI (2048)	256	128	12	14P, 14SL, 14ST	ADC/Comp	—	20	1	1-16 bit, 2-8 bit, WDT	1	4x10 bit	—	—	PICKit™ 1
PIC16F716	3584 StdFI (2048)	—	128	13	18P, 18SO, 20SS	ADC	—	20	1	1-16 bit, 2-8 bit, WDT	1	4x10 bit	—	—	DM163022, PICDEM™ 2 Plus

***Refer to dsPIC DSC Brochure for further details.
Refer to Design pages on www.microchip.com for further details.
Abbreviations are found on the last page of the Selector Guide.

Product	Program Memory Bytes & Type (Words)	EEPROM Data Memory Bytes	RAM Bytes	I/O Pins	Packages	Analog Peripherals	Digital Peripherals	Max. Speed MHz	ICD # of Breakpoints	Function-Specific Features					Development Boards
										Timers	Input Capture	Output Comp/Std PWM	Motor Control PWM	Quadrature Encoder	
Motor Control Solutions (continued)															
PIC16F737	7168 StdFI (4096)	—	368	25	28SP, 28SO, 28SS, 28ML	ADC/Comp	USART, MI ² C/SPI	20	1	1-16 bit, 2-8 bit, WDT	3	3x10 bit	—	—	DM163022, PICDEM™ 2 Plus
PIC16F747	7168 StdFI (4096)	—	368	36	40P, 44PT, 44ML	ADC/Comp	USART, MI ² C/SPI	20	1	1-16 bit, 2-8 bit, WDT	3	3x10 bit	—	—	DM163022, PICDEM™ 2 Plus
PIC16F767	14336 StdFI (8192)	—	368	25	28SP, 28SO, 28SS, 28ML	ADC/Comp	USART, MI ² C/SPI	20	1	1-16 bit, 2-8 bit, WDT	3	3x10 bit	—	—	DM163022, PICDEM™ 2 Plus
PIC16F777	14336 StdFI (8192)	—	368	36	40P, 44PT, 44ML	ADC/Comp	USART, MI ² C/SPI	20	1	1-16 bit, 2-8 bit, WDT	3	3x10 bit	—	—	DM163022, PICDEM™ 2 Plus
PIC18F2331	8192 EnhFI (4096)	256	768	22	28SP, 28SO, 28MM	200 ksps ADC	EUSART, I ² C/SPI	40	1	3-16 bit, 1-8 bit, WDT	3	2x10 bit	6	Yes	DM183011, PICDEM™ MC
PIC18F2431	16384 EnhFI (8192)	256	768	22	28SP, 28SO, 28MM	200 ksps ADC	EUSART, I ² C/SPI	40	1	3-16 bit, 1-8 bit, WDT	3	2x10 bit	6	Yes	DM183011, PICDEM™ MC
PIC18F4331	8192 EnhFI (4096)	256	768	34	40P, 44PT, 44ML	200 ksps ADC	EUSART, I ² C/SPI	40	1	3-16 bit, 1-8 bit, WDT	3	2x10 bit	8	Yes	DM183011, PICDEM™ MC
PIC18F4431	16384 EnhFI (8192)	256	768	34	40P, 44PT, 44ML	200 ksps ADC	EUSART, I ² C/SPI	40	1	3-16 bit, 1-8 bit, WDT	3	2x10 bit	8	Yes	DM183011, PICDEM™ MC
dsPIC30F2010	12288 EnhFI (4096)	1024	512	20	28SO, 28SP, 28MM	500 ksps ADC	UART, I ² C/SPI	120	1	3-16 bit, WDT	4	2	6	Yes	DM300020***
dsPIC30F3010	24576 EnhFI (8102)	1024	1024	20	28SO, 28SP, 44ML (8x8)	500 ksps ADC	UART, I ² C/SPI	120	2	5-16 bit, WDT	4	2	6	Yes	DM300020***
dsPIC30F4012	49152 EnhFI (16384)	1024	2048	20	28SO, 28SP, 44ML (8x8)	500 ksps ADC	UART, I ² C/SPI, CAN	120	1	5-16 bit, WDt	4	2	6	Yes	DM300020***
dsPIC30F3011	24576 EnhFI (8102)	1024	1024	30	40P, 44PT, 44ML (8x8)	500 ksps ADC	UART, I ² C/SPI	120	2	5-16 bit, WDT	4	4	6	Yes	DM300020***
dsPIC30F4011	49152 EnhFI (16384)	1024	2048	30	40P, 44PT, 44ML (8x8)	500 ksps ADC	UART, I ² C/SPI, CAN	120	1	5-16 bit, WDT	4	4	6	Yes	DM300020***
dsPIC30F6010	147456 EnhFI (49152)	4096	8192	68	80PF	500 ksps ADC	UART, I ² C/SPI, CAN	120	4	5-16 bit, WDT	8	8	8	Yes	DM300020***

***Refer to dsPIC DSC Brochure for further details.

Refer to Design pages on www.microchip.com for further details.

Abbreviations are found on the last page of the Selector Guide.

Product	Program Memory Bytes & Type (Words)	EEPROM Data Memory Bytes	SRAM Bytes	I/O Pins (max.)	Packages	A/D 12-bit 100 KSPS (ch)	A/D 10-bit 500 KSPS	Timer 16-bit	Input Cap	Output Comp/Std PWM	Motor Control PWM	Quad. Encoder	UART	SPI™	I ² C™
High Speed Sensor Solutions															
dsPIC30F2011	12288 EnhFI (4096)	—	1024	12	18SO, 18P, 28ML (6x6)	8	—	3	2	2	—	—	1	1	1
dsPIC30F3012	24576 EnhFI (8192)	1024	2048	12	18SO, 18P, 44ML (8x8)	8	—	3	2	2	—	—	1	1	1
dsPIC30F2012	12288 EnhFI (4096)	—	1024	20	28SO, 28SP, 28ML (6x6)	10	—	3	2	2	—	—	1	1	1
dsPIC30F3013	24576EnhFI (8192)	1024	2048	20	28SO, 28SP, 44ML (8x8)	10	—	3	2	2	—	—	2	1	1

Abbreviations are found on the last page of the Selector Guide.

Power-Managed Solutions Featuring *nanoWatt* Technology

Minimum nanoWatt Feature Set (VDD = 2.0-5.5V)	6-20 Pin	28-44 Pin	64-80 Pin
Internal Oscillator	PIC16F627A, PIC16F628A, PIC16F648A		
Quick Start-up (4 MHz)			
Power-Managed Modes			
Sleep			
Low-Power Timer1	PIC16F818, PIC16F819	28-44 Pin	64-80 Pin
Low-Power Watchdog			
Additional Features to Minimum			
IntOSC: Quick Start-up (Two speed) and Clock Divide (8 MHz) BOR			
IntOSC: Quick Start-up (Two speed), Fail-safe Clock Monitor and Clock Divide (8 MHz) Ultra Low-Power Wake-up	PIC12F683 PIC16F684, PIC16F688		
IntOSC: Quick Start-up (Two speed), Fail-safe Clock Monitor and Clock Divide (8 MHz) Ultra Low-Power Wake-up Low-Power Watchdog – Enhanced Software Controlled BOR	PIC16F631, PIC16F677, PIC16F685, PIC16F687, PIC16F689, PIC16F785, PIC16F690		
IntOSC: Quick Start-up (Two speed), Fail-safe Clock Monitor and Clock Divide (8 MHz) Ultra Low-Power Wake-up Wake-up Reset Low-Power Watchdog – Enhanced PLVD Software Controlled BOR	PIC12F635 PIC16F636, PIC16F639		
IntOSC: Quick Start-up (Two speed), Fail-safe Clock Monitor and Selectable Clock (31 kHz-8 MHz) Power-Managed Modes: RC Run Modes PLVD PBOR	PIC16F87, PIC16F88	PIC16F737, PIC16F747, PIC16F767, PIC16F777, PIC16F913, PIC16F914, PIC16F916, PIC16F917	

For additional details, please refer to device data sheets and design pages on www.microchip.com.

Power-Managed Solutions Featuring *nanoWatt* Technology (continued)

Additional Features to Minimum	6-20 Pin	28-44 Pin	64-80 Pin
IntOSC: Quick Start-up (Two speed), Fail-safe Clock Monitor and Selectable Clock (31 kHz) Power-Managed Modes: Multiple Idle Modes and RC Run Modes BOR		PIC18F24J10, PIC18F25J10, PIC18F45J10, PIC18F44J10,	PIC18F65J10, PIC18F65J15, PIC18F66J10, PIC18F66J15, PIC18F67J10, PIC18F85J10, PIC18F85J15, PIC18F86J10, PIC18F86J15, PIC18F87J10,
IntOSC: Quick Start-up (Two speed), Fail-safe Clock Monitor and Selectable Clock (31 kHz - 8 MHz) Power-Managed Modes: Multiple Idle Modes and RC Run Modes PLVD PBOR	PIC18F1220, PIC18F1320	PIC18F2220, PIC18F2221, PIC18F2320, PIC18F2321, PIC18F2331, PIC18F2410, PIC18F2420, PIC18F2431, PIC18F2480, PIC18F2510, PIC18F2515, PIC18F2520, PIC18F2525, PIC18F2550, PIC18F2580, PIC18F2585, PIC18F2610, PIC18F2620, PIC18F2680, PIC18F4220, PIC18F4221, PIC18F4320, PIC18F4321, PIC18F4331, PIC18F4410, PIC18F4420, PIC18F4431, PIC18F4455, PIC18F4480, PIC18F4510, PIC18F4515, PIC18F4520, PIC18F4525, PIC18F4550, PIC18F4580, PIC18F4585, PIC18F4610, PIC18F4620, PIC18F4680	PIC18F6310, PIC18F6390, PIC18F6410, PIC18F6490, PIC18F6522, PIC18F6527, PIC18F6622, PIC18F6722, PIC18F8310, PIC18F8390, PIC18F8410, PIC18F8490, PIC18F8522, PIC18F8527, PIC18F8622, PIC18F8627, PIC18F8722

For additional details, please refer to device data sheets and design pages on www.microchip.com.

MATURE – PICmicro[®] MICROCONTROLLER FAMILY PRODUCTS

Not recommended for new designs.

Please use a device from the recommended column for new designs.

Product	Program Memory (Bytes/Words)	Package Size	Recommended Design-In Device
PIC12C508	768/512x12	8	PIC12F508
PIC12C508A	768/512x12	8	PIC12F508
PIC12C509	1536/1024x12	8	PIC12F509
PIC12C509A	1536/1024x12	8	PIC12F509
PIC12C671	1536/1024x14	8	PIC12F675
PIC12C672	3584/2048x14	8	PIC12F683
PIC12CE673	1792/1024x14	8	PIC12F675
PIC12CE674	3584/2048x14	8	PIC12F683
PIC12CE518	768/512x12	8	PIC12F629
PIC12CE519	1536/1024x12	8	PIC12F629
PIC12CR509A	1536/1024x12	8	PIC12F509
PIC16C505	1536/1024x12	14	PIC16F505
PIC16C54	768/512x12	18	PIC16F54
PIC16C54A	768/512x12	18	PIC16F54
PIC16C54C	768/512x12	18	PIC16F54
PIC16C55	768/512x12	28	PIC16C55A
PIC16C56	1536/1024x12	18	PIC16C56A
PIC16C57	3072/2048x12	28	PIC16F57
PIC16C57C	3072/2048x12	28	PIC16F57
PIC16C62A	3584/2048x14	28	PIC16C62B or PIC16F72
PIC16C620	896/2048x14	18	PIC16C620A
PIC16C621	1792/1024x14	18	PIC16C621A
PIC16C622	3584/2048x14	18	PIC16C622A
PIC16C63	7168/4096x14	28	PIC16C63B or PIC16F73
PIC16C64A	3584/2048x14	40	PIC16F74
PIC16C642	7168/4096x14	28	PIC16F72
PIC16C65A	7168/4096x14	40	PIC16C65B or PIC16F74
PIC16C66	14336/8192x14	28	PIC16F76
PIC16C662	7168/4096x14	40	PIC16F74
PIC16C67	14336/8192x14	40	PIC16F77
PIC16C71	1792/1024x14	18	PIC16F716
PIC16C72	3584/2048x14	28	PIC16F72
PIC16C72A	3584/2048x14	28	PIC16F72
PIC16C710	896/512x14	18	PIC16F716
PIC16C711	1792/1024x14	18	PIC16F716
PIC16C712	1792/1024x14	18	PIC16F716
PIC16C715	3584/2048x14	18	PIC16F716

Product	Program Memory (Bytes/Words)	Package Size	Recommended Design-In Device
PIC16C716	3584/2048x14	18	PIC16F716
PIC16C73A	7168/4096x14	28	PIC16F73
PIC16C73B	7168/4096x14	28	PIC16F73
PIC16C74A	7168/4096x14	40	PIC16F74
PIC16C74B	7168/4096x14	40	PIC16F74
PIC16C76	14336/8192x14	28	PIC16F76
PIC16C77	14336/8192x14	40	PIC16F77
PIC16C923	7168/4096x14	68	PIC16C925
PIC16C924	7168/4096x14	68	PIC16C925
PIC16CE623	896/512x14	18	PIC16F627A
PIC16CE624	1792/1024x14	18	PIC16F627A
PIC16CE625	3584/2048x14	18	PIC16F628A
PIC16CR54A	768/512x12	18	PIC16CR54C
PIC16CR54C	768/512x12	18	PIC16F54
PIC16CR57C	3072/2048x12	28	PIC16F57
PIC16CR83	896/512x14	18	PIC16F84A
PIC16CR84	1792/1024x14	18	PIC16F84A
PIC16F627	1792/1024x14	18	PIC16F627A
PIC16F628	3584/2048x14	18	PIC16F628A
PIC16F83	896/512x14	18	PIC16F84A
PIC16F84	1792/1024x14	18	PIC16F84A
PIC16F873	7168/4096x14	28	PIC16F873A
PIC16F874	7168/4096x14	28	PIC16F874A
PIC16F876	14336/8192x14	40	PIC16F876A
PIC16F877	14336/8192x14	40	PIC16F877A
PIC17C42A	4096/2048x16	40	PIC18F4220
PIC17C43	8192/4096x16	40	PIC18F4320
PIC17C44	16384/8192x16	40	PIC18F442
PIC17C752	16384/8192x16	68	PIC18F6520
PIC17C756A	32768/16384x16	68	PIC18F6520
PIC17C762	16384/8192x16	84	PIC18F8520
PIC17C766	32768/16384x16	84	PIC18F8520
PIC18C242	16384/8192x16	28	PIC18F2420
PIC18C252	32768/16384x16	28	PIC18F2520
PIC18C442	16384/8192x16	40	PIC18F4420
PIC18C452	32768/16384x16	40	PIC18F4520
PIC18C658	32768/16384x16	68	PIC18F6585

Product	Program Memory (Bytes/Words)	Package Size	Recommended Design-In Device
PIC18C858	32768/16384x16	84	PIC18F8585
PIC18F242	16384/8192x16	28	PIC18F2420
PIC18F248	16384/8192x16	28	PIC18F2480
PIC18F252	32768/16384x16	28	PIC18F2520
PIC18F258	32768/16384x16	28	PIC18F2580
PIC18F442	16384/8192x16	40	PIC18F4420
PIC18F448	16384/8192x16	40	PIC18F4480
PIC18F452	32768/16384x16	40	PIC18F4520

Product	Program Memory (Bytes/Words)	Package Size	Recommended Design-In Device
PIC18F458	32768/16384x16	40	PIC18F4580
PIC18F2439	12288/6144x16	28	PIC18F2431
PIC18F2539	24576/12288x16	28	PIC18F2431
PIC18F4439	12288/6144x16	40	PIC18F4431
PIC18F4539	24576/12288x16	40	PIC18F4431
PIC18F6620	65536/32768x16	64	PIC18F6621
PIC18F8620	65536/32768x16	80	PIC18F8621

BATTERY MANAGEMENT FAMILY PRODUCTS

Battery Fuel Gauge ICs												
Product	Battery Chemistry	# of Cells	Interface	Data Set	A/D Converter	Programmable Memory	Programmable I/O Functions	Accuracy	Time Base	Temp. Sensor	Packaging	Description
PS501	Li-Ion NiMH	2-4 6-12	SMBus	> 1%	16-bit Sigma Delta	16 Kbytes Flash, 256 bytes EEPROM	12 GPIO	N/A	On-chip	On-chip external	28SSOP	Single chip reprogrammable battery manager IC reports capacity, current, temperature, voltage and other status for Li-Ion or Nickel batteries.
PS700	Li-Ion	1 - 2	SMBus v1.1	> 1%	16-bit Sigma Delta	512 bytes EEPROM	1 A/D input, 2 inputs configurable as GPIO or A/D inputs	N/A	On-chip	On-chip and external	8TSOP	Highly accurate analog front end that measures, stores and reports all of the critical parameters required for rechargeable battery monitoring with a minimum of external components.
NEW PS810*	Li-Ion	1	SMBus/SPS	N/A	16-bit Sigma Delta	4k x 16 Flash	6 GPIO	1%	On-chip	On-chip	14ST, 16ML	Single cell Li-Ion fuel gauge provides battery status such as run time to empty, run time to full, relative state-of-charge and battery state-of-health

* Contact Microchip Technology for availability.

Supporting Development Tools are listed in the Development Systems Products Section.

Abbreviations are found on the last page of the Selector Guide.

Switching Battery Chargers								
Product	Mode	Cell Type	# of Cells	Vin Range (V)	Max. Voltage Regulation (%)	Int/Ext FET	Features	Package
NEW PS200*	Switch	Li-Ion, Li-Polymer, NiMH, NiCD, Pb	multi	5 -18	±1%	Ext	Voltage and current regulation, safety charge timers and temperature limits, internal voltage regulator, 1 MHz (max.) PWM	20P, 20SO, 20SS

* Contact Microchip Technology for availability.

For Linear Battery Chargers, refer to Analog/Interface Family Products.

Supporting Development Tools are listed in the Development Systems Products Section.

Abbreviations are found on the last page of the Selector Guide.

RADIO FREQUENCY PRODUCTS

PASSIVE								
microID® RFID Tagging Devices								
Product	Carrier Frequency	Programming	Anticollision	Memory Type	Memory Size	Protocols	Packages	Other
MCRF200	100-150 kHz	Factory	No	OTP	96/128 bits	PSK, FSK, ASK, bi-phase, Manchester, NRZ	W, WF, S, WB, WFB, SB, 1M, 3M, P, SN	–
MCRF202	100-150 kHz	Factory	Yes	OTP	96/128 bits	FSK, ASK, bi-phase, Manchester, NRZ	W, WF, S, WB, WFB, SB, P, SN	Sensor input
MCRF250	100-150 kHz	Factory	Yes	OTP	96/128 bits	PSK, FSK, ASK, bi-phase, Manchester, NRZ	W, WF, S, WB, WFB, SB, 1M, 3M, P, SN	–
MCRF355	13.56 MHz	Contact/Factory	Yes	R/W	154 bits	ASK Manchester	W, WF, S, WB, WFB, SB, P, SN, 7M	–
MCRF360	13.56 MHz	Contact/Factory	Yes	R/W	154 bits	ASK Manchester	W, WF, S, WB, WFB, SB, P, SN	100 pF res cap
MCRF450	13.56 MHz	Contactless	Yes	R/W	1 Kbit	PPM, ASK Manchester	W, WF, S, WB, WFB, SB, P, SN, 7M	32-bit unique ID user lock control by block
MCRF451	13.56 MHz	Contactless	Yes	R/W	1 Kbit	PPM, ASK Manchester	W, WF, S, WB, WFB, SB, P, SN, 7M	100 pF res cap
MCRF452	13.56 MHz	Contactless	Yes	R/W	1 Kbit	PPM, ASK Manchester	W, WF, S, WB, WFB, SB, P, SN, 7M	Dual 50 pF res cap
MCRF455	13.56 MHz	Contactless	Yes	R/W	1 Kbit	PPM, ASK Manchester	W, WF, S, WB, WFB, SB, P, SN, 7M	50 pF res cap

SECURE DATA PRODUCTS

KEELOQ® Encoder Devices															
Product	Transmission Code Length Bits	Code Hopping Bits	Programmable Encryption Key Bits	Seed Length	Operating Voltage (V)	Turnable OSC	Function Codes	CRC	Protocols	Other Features			Packages		
HCS101	66	—	—	—	3.5 to 13.0	✓	7	No	PWM	Fixed code support for non-secure applications, up to 28-bit serial numbers			8P, 8SN		
HCS200	66	32	64	32	3.5 to 13.0	No	7	No	PWM	Entry level, Fixed code support, Battery-low indicator			8P, 8SN		
HCS201	66	32	64	32	3.5 to 13.0	✓	7	No	PWM	Entry level, Fixed code support, Battery-low indicator, Step-up voltage operation			8P, 8SN		
HCS300	66	32	64	32	2.0 to 6.3	No	15	No	PWM	LED Drive, Overflow bits, Time-out, Battery-low indicator			8P, 8SN		
HCS301	66	32	64	32	3.5 to 13.0	No	15	No	PWM	LED Drive, Overflow bits, Time-out, Battery-low indicator			8P, 8SN		
HCS320	66	32	64	32	3.5 to 13.0	No	16	No	PWM	Shift Operation, LED Drive, Overflow bits, Time-out, Battery-low indicator			8P, 8SN		
HCS360	67	32	64	48	2.0 to 6.3	No	15	✓	IR Mode, PWM and Manchester	2 independent counters			8P, 8SN		
HCS361	67	32	64	48	2.0 to 6.3	No	15	✓	IR Mode, PWM and VPWM	2 independent counters			8P, 8SN		
HCS362	69	32	2 x 64	60	2.0 to 6.3	✓	15	✓	PWM and Manchester	Queue counter, PLL interface, Timer bits, Programmable time-out			8P, 8SN, 8ST		
HCS365	69	32	2 x 64	2 x 60	2.05 to 5.5	Factory	15	✓	PWM, VPWM PPM and Manchester	Dual Encoder Operation, 4 inputs, Queue counter			8P, 8SM		
HCS370	69	32	2 x 64	2 x 60	2.05 to 5.5	Factory	15	✓	PWM, VPWM PPM and Manchester	Step-up voltage regulation, Dual Encoder Operation, 6 inputs, Queue counter			14P, 14SL		
HCS410	69	32	2 x 64	60	2.0 to 6.6	✓	7	✓	PWM and Manchester	Self-powered transponder and encoder, Bidirectional authentication, User EEPROM, Queue counter			8P, 8SN, 8ST		
KEELOQ® Decoder Devices															
Product	Reception Length Bits	Encoders Supported**			Transmitters Supported	Operating Voltage (V)	Functions			Other Features			Packages		
HCS500	66	HCS200, HCS201, HCS300, HCS301, HCS320, HCS360, HCS361, HCS362, HCS365, HCS370, HCS410, HCS412, HCS473			Up to 7	3.0 to 5.5	S0, 15 Serial Functions			Full-featured decoder with serial interface to microcontrollers			8P, 8SM		
HCS512	66	HCS200, HCS201, HCS300, HCS301, HCS320, HCS360, HCS361, HCS362, HCS365, HCS370, HCS410, HCS412, HCS473			Up to 4	4.0 to 6.0	S0, S1, S2, S3; VLOW, 15 Serial Functions			Single-chip decoder with secure learning			18P, 18SO		
HCS515	66	HCS200, HCS201, HCS300, HCS301, HCS320, HCS360, HCS361, HCS362, HCS365, HCS370, HCS410, HCS412, HCS473			Up to 7	4.5 to 5.5	S0, S1, 15 Serial Functions			Full-featured decoder with serial and parallel interface. On-chip 1K transmitter and 1K user EEPROM.			14P, 14SL		
KEELOQ® Programmable Encoder/Decoder Flash Devices (x14), ICSP™															
Product	Program Memory Bytes & Type (Words)	EEPROM Data Memory (Bytes)	RAM Bytes	I/O Pins	Analog		Digital		Max. Speed MHz	IntOSC	BOR/PBOR/PLVD	ICD # of Breakpoints	nW	Other Features	Packages
					ADC Channels	Comparators	Timers/WDT	Serial I/O							
PIC12F635	1792 EnhFI (1024)	128	64	6	—	1	1-16 bit, 1-8 bit, 1-WDT	—	20	8 MHz	BOR/PLVD	1**	✓		8P, 8SN, 8MF
PIC16F636	3584 EnhFI (2048)	256	128	12	—	2	1-16 bit, 1-8 bit, 1-WDT	—	20	8 MHz	BOR/PLVD	1**	✓		14P, 14SL, 14ST
PIC16F639*	3584 EnhFI (2048)	256	128	12	—	2	1-16 bit, 1-8 bit, 1-WDT	—	20	8 MHz	BOR/PLVD	1**	✓	Transponder Analog Front End	20P, 20SO, 20SS

* Contact Microchip Technology for availability date.

** Requires ICD specific device with header module – refer to Development Tools.

Abbreviations are found on the last page of the Selector Guide.

ANALOG/INTERFACE PRODUCTS

Lead-free versions of many devices are currently offered. Check Microchip's website for availability.

THERMAL MANAGEMENT PRODUCTS – Temperature Sensors							
Part #	Typical Accuracy (°C)	Maximum Accuracy @ 25°C (°C)	Maximum Temperature Range (°C)	Vcc Range (V)	Maximum Supply Current (μA)	Features	Packages
Logic Output Temperature Sensors							
TC6501	±0.5	±3	-55 to +125	+2.7 to +5.5	40	Cross to MAX6501, Open-drain	5-Pin SOT-23A
TC6502	±0.5	±3	-55 to +125	+2.7 to +5.5	40	Cross to MAX6502, Push-pull	5-Pin SOT-23A
TC6503	±0.5	±3	-55 to +125	+2.7 to +5.5	40	Cross to MAX6503, Open-drain	5-Pin SOT-23A
TC6504	±0.5	±3	-55 to +125	+2.7 to +5.5	40	Cross to MAX6504, Push-pull	5-Pin SOT-23A
TC620	±1	±3	-40 to +125	+4.5 to +18	400	Two resistor-programmable trip points	8-Pin PDIP, 8-Pin SOIC
TC621	Note 1	Note 1	-40 to +85	+4.5 to +18	400	Requires external thermistor, resistor-programmable trip points	8-Pin PDIP, 8-Pin SOIC
TC622	±1	±5	-40 to +125	+4.5 to +18	600	Dual output, TO-220 for heat sink mounting, resistor-programmable trip points	8-Pin PDIP, 8-Pin SOIC, 5-Pin TO-220
TC623	±1	±3	-40 to +125	+2.7 to +4.5	250	Two resistor-programmable trip points	8-Pin PDIP, 8-Pin SOIC
TC624	±1	±5	-40 to +125	+2.7 to +4.5	300	Dual output, resistor-programmable trip points	8-Pin PDIP, 8-Pin SOIC
Voltage Output Temperature Sensors							
MCP9700	±1	±4	-40 to +125	+2.3 to +5.5	12	Temperature slope: 10 mV/°C	5-pin SC-70
MCP9701	±1	±4	-10 to +125	+3.1 to +5.5	12	Temperature slope: 19.53 mV/°C, cross to MAX6612	5-pin SC-70
TC1046	±0.5	±2	-40 to +125	+2.7 to +4.4	60	High precision temperature-to-voltage converter, 6.25 mV/°C	3-Pin SOT-23B
TC1047	±0.5	±2	-40 to +125	+2.7 to +4.4	60	High precision temperature-to-voltage converter, 10 mV/°C	3-Pin SOT-23B
TC1047A	±0.5	±2	-40 to +125	+2.5 to +5.5	60	High precision temperature-to-voltage converter, 10 mV/°C	3-Pin SOT-23B
Serial Output Temperature Sensors							
MCP9800	±0.5	±1	-55 to +125	+2.7 to +5.5	400	SMBus/I ² C™ compatible interface, 0.0625°C to 0.5°C adj. resolution, power-saving one-shot temperature measurement	5-Pin SOT-23
MCP9801	±0.5	±1	-55 to +125	+2.7 to +5.5	400	SMBus/I ² C™ compatible interface, 0.0625°C to 0.5°C adj. resolution, power-saving one-shot temperature measurement, multi-drop capability	8-Pin MSOP, 8-pin SOIC
MCP9802	±0.5	±1	-55 to +125	+2.7 to +5.5	400	SMBus/I ² C™ compatible interface with time out, 0.0625°C to 0.5°C adj. resolution, power-saving one-shot temperature measurement	5-Pin SOT-23

NOTE 1: These devices use an external temperature sensor. Accuracy of the total solution is a function of the accuracy of the external sensor.
NOTE 2: TCN75 idle current is 250 μA. This device also has a Software Shutdown mode that reduces supply current to <1 μA.

THERMAL MANAGEMENT PRODUCTS – Temperature Sensors

Part #	Typical Accuracy (°C)	Maximum Accuracy @ 25°C (°C)	Maximum Temperature Range (°C)	Vcc Range (V)	Maximum Supply Current (µA)	Features	Packages
Serial Output Temperature Sensors (continued)							
MCP9803	±0.5	±1	-55 to +125	+2.7 to +5.5	400	SMBus/I ² C™ compatible interface with time out, 0.0625°C to 0.5°C adj. resolution, power-saving one-shot temperature measurement, multi-drop capability	8-Pin MSOP, 8-Pin SOIC
TC77	±0.5	±1	-55 to +125	+2.7 to +5.5	400	SPI™ compatible interface, 0.0625°C temperature resolution	5-Pin SOT-23A, 8-Pin SOIC
TC72	±0.5	±1	-55 to +125	+2.65 to +5.5	400	SPI™ compatible interface, power saving one-shot temperature measurement, 0.25°C temperature resolution	8-Pin MSOP, 8-Pin 3x3 DFN
TC74	±0.5	±2	-40 to +125	+2.7 to +5.5	350	SMBus/I ² C™ compatible interface, 1°C temperature resolution	5-Pin SOT-23A, 5-Pin TO-220
TCN75A	±0.5	±2	-40 to +125	+2.7 to +5.5	500	SMBus/I ² C™ compatible interface, adjustable resolution, power-saving one-shot temperature measurement, multi-drop capability, 0.0625°C to 0.5°C temperature resolution	8-Pin SOIC, 8-Pin MSOP
TCN75	±0.5	±2	-55 to +125	+2.7 to +5.5	1,000 ⁽²⁾	SMBus/I ² C™ compatible interface, multi-drop capability, interrupt output, 0.5°C temperature resolution	8-Pin MSOP, 8-Pin SOIC

NOTE 1: These devices use an external temperature sensor. Accuracy of the total solution is a function of the accuracy of the external sensor.
NOTE 2: TCN75 idle current is 250 µA. This device also has a Software Shutdown mode that reduces supply current to <1 µA.

THERMAL MANAGEMENT PRODUCTS – Brushless DC Fan Controllers and Fan Fault Detectors

Part #	Description	Typical Accuracy (°C)	Maximum Accuracy @ 25°C (°C)	Maximum Temperature Range (°C)	Vcc Range (V)	Maximum Supply Current (µA)	Features	Packages
TC642	Fan Manager	Note 1	Note 1	-40 to +85	+3.0 to +5.5	1,000	FanSense™ Fan Monitor, minimum fan speed control	8-Pin PDIP, 8-Pin SOIC, 8-Pin MSOP
TC642B	Fan Manager	Note 1	Note 1	-40 to +85	+3.0 to +5.5	400	FanSense™ Fan Monitor, minimum fan speed control, fan auto-restart	8-Pin PDIP, 8-Pin SOIC, 8-Pin MSOP
TC646	Fan Manager	Note 1	Note 1	-40 to +85	+3.0 to +5.5	1,000	FanSense™ Fan Monitor, auto-shutdown	8-Pin PDIP, 8-Pin SOIC, 8-Pin MSOP
TC646B	Fan Manager	Note 1	Note 1	-40 to +85	+3.0 to +5.5	400	FanSense™ Fan Monitor, auto-shutdown, fan auto-restart	8-Pin PDIP, 8-Pin SOIC, 8-Pin MSOP
TC647	Fan Manager	Note 1	Note 1	-40 to +85	+3.0 to +5.5	1,000	FanSense™ Fan Monitor, minimum fan speed control	8-Pin PDIP, 8-Pin SOIC, 8-Pin MSOP
TC647B	Fan Manager	Note 1	Note 1	-40 to +85	+3.0 to +5.5	400	FanSense™ Fan Monitor, minimum fan speed control, fan auto-restart	8-Pin PDIP, 8-Pin SOIC, 8-Pin MSOP
TC648	Fan Manager	Note 1	Note 1	-40 to +85	+3.0 to +5.5	1,000	Over-temperature alert, auto-shutdown	8-Pin PDIP, 8-Pin SOIC, 8-Pin MSOP

NOTE 1: These devices use an external temperature sensor. Accuracy of the total solution is a function of the accuracy of the external sensor.

THERMAL MANAGEMENT PRODUCTS – Brushless DC Fan Controllers and Fan Fault Detectors

Part #	Description	Typical Accuracy (°C)	Maximum Accuracy @ 25°C (°C)	Maximum Temperature Range (°C)	Vcc Range (V)	Maximum Supply Current (μA)	Features	Packages
TC648B	Fan Manager	Note 1	Note 1	-40 to +85	+3.0 to +5.5	400	Over-temperature alert, auto-shutdown, fan auto-restart	8-Pin PDIP, 8-Pin SOIC, 8-Pin MSOP
TC649	Fan Manager	Note 1	Note 1	-40 to +85	+3.0 to +5.5	1,000	FanSense™ Fan Monitor, auto-shutdown	8-Pin PDIP, 8-Pin SOIC, 8-Pin MSOP
TC649B	Fan Manager	Note 1	Note 1	-40 to +85	+3.0 to +5.5	400	FanSense™ Fan Monitor, auto-shutdown, fan auto-restart	8-Pin PDIP, 8-Pin SOIC, 8-Pin MSOP
TC650	Fan Manager	±1	±3	-40 to +125	+2.8 to +5.5	90	Over-temperature alert	8-Pin MSOP
TC651	Fan Manager	±1	±3	-40 to +125	+2.8 to +5.5	90	Over-temperature alert, auto-shutdown	8-Pin MSOP
TC652	Fan Manager	±1	±3	-40 to +125	+2.8 to +5.5	90	FanSense™ Fan Monitor, over-temperature alert	8-Pin MSOP
TC653	Fan Manager	±1	±3	-40 to +125	+2.8 to +5.5	90	FanSense™ Fan Monitor, over-temperature alert, auto-shutdown	8-Pin MSOP
TC654	Dual SMBus Fan Manager	Note 1	Note 1	-40 to +85	+3.0 to +5.5	320	FanSense™ Fan Monitor, RPM data	10-Pin MSOP
TC655	Dual SMBus Fan Manager	Note 1	Note 1	-40 to +85	+3.0 to +5.5	320	FanSense™ Fan Monitor, RPM data, over-temperature alert	10-Pin MSOP
TC664	Single SMBus Fan Manager	Note 1	Note 1	-40 to +85	+3.0 to +5.5	320	FanSense™ Fan Monitor, RPM data	10-Pin MSOP
TC665	Single SMBus Fan Manager	Note 1	Note 1	-40 to +85	+3.0 to +5.5	320	FanSense™ Fan Monitor, RPM data, over-temperature alert	10-Pin MSOP
TC670	Predictive Fan Fault Detector	N/A	N/A	-40 to +85	+3.0 to +5.5	150	FanSense™ Fan Monitor, programmable threshold	6-Pin SOT-23

NOTE 1: These devices use an external temperature sensor. Accuracy of the total solution is a function of the accuracy of the external sensor.

POWER MANAGEMENT – Voltage References

Part #	Vcc Range (V)	Output Voltage (V)	Max. Load Current (mA)	Initial Accuracy (max.%)	Temperature Coefficient (ppm/°C)	Max. Supply Current (μA @ 25°C)	Packages
MCP1525	2.7 to 5.5	2.5	±2	±1	50	100	3-Pin TO-92, 3-Pin SOT-23B
MCP1541	4.3 to 5.5	4.096	±2	±1	50	100	3-Pin TO-92, 3-Pin SOT-23B

POWER MANAGEMENT – Linear Regulators

Part #	Max. Input Voltage (V)	Output Voltage (V)	Output Current (mA)	Junction Temperature Range (°C)	Typical Active Current (µA)	Typical Dropout Voltage @ Max. I _{OUT} (mV)	Typical Output Voltage Accuracy (%)	Features	Packages
50 mA to 250 mA Low Dropout Linear Regulators									
TC2014	6.0	1.8, 2.7, 2.8, 3.0, 3.3	50	-40 to +125	55	45	±0.4	Shutdown, Reference bypass input	5-Pin SOT-23A
TC1014	6.0	1.8, 2.5, 2.7, 2.8, 2.85, 3.0, 3.3, 3.6, 4.0, 5.0	50	-40 to +125	50	85	±0.5	Shutdown, Reference bypass input	5-Pin SOT-23A
TC2054	6.0	1.8, 2.7, 2.8, 3.0, 3.3	50	-40 to +125	55	45	±0.4	Shutdown, Error output	5-Pin SOT-23A
TC1054	6.0	1.8, 2.5, 2.7, 2.8, 2.85, 3.0, 3.3, 3.6, 4.0, 5.0	50	-40 to +125	50	85	±0.5	Shutdown, Error output	5-Pin SOT-23A
TC1070	6.0	1.23 → V _{IN}	50	-40 to +125	50	85	—	Shutdown, Adjustable	5-Pin SOT-23A
TC1072	6.0	2.5, 2.7, 2.8, 2.85, 3.0, 3.3, 3.6, 4.0, 5.0	50	-40 to +125	50	85	±0.5	Shutdown, Reference bypass input, Error output	6-Pin SOT-23A
TC1223	6.0	2.5, 2.7, 2.8, 3.0, 3.3, 3.6, 4.0, 5.0	50	-40 to +125	50	85	±0.5	Shutdown	5-Pin SOT-23A
TC1016	6.0	1.8, 2.7, 2.8, 3.0	80	-40 to +125	50	150	±0.5	Shutdown	5-Pin SC-70
TC2015	6.0	1.8, 2.7, 2.8, 3.0, 3.3	100	-40 to +125	55	90	±0.4	Shutdown, Reference bypass input	5-Pin SOT-23A
TC1015	6.0	1.8, 2.5, 2.7, 2.8, 2.85, 3.0, 3.3, 3.6, 4.0, 5.0	100	-40 to +125	50	180	±0.5	Shutdown, Reference bypass input	5-Pin SOT-23A
TC2055	6.0	1.8, 2.7, 2.8, 3.0, 3.3	100	-40 to +125	55	90	±0.4	Shutdown, Error output	5-Pin SOT-23A
TC1055	6.0	1.8, 2.5, 2.7, 2.8, 2.85, 3.0, 3.3, 3.6, 4.0, 5.0	100	-40 to +125	50	180	±0.5	Shutdown, Error output	5-Pin SOT-23A
TC1071	6.0	1.23 → V _{IN}	100	-40 to +125	50	180	—	Shutdown, Adjustable	5-Pin SOT-23A
TC1073	6.0	2.5, 2.7, 2.8, 2.85, 3.0, 3.3, 3.6, 4.0, 5.0	100	-40 to +125	50	180	±0.5	Shutdown, Reference bypass input, Error output	6-Pin SOT-23A
TC1224	6.0	2.5, 2.7, 2.8, 3.0, 3.3, 3.6, 4.0, 5.0	100	-40 to +125	50	180	±0.5	Shutdown	5-Pin SOT-23A
TC1188	6.0	1.8, 2.8, 2.84, 3.15	120	-40 to +125	50	130	±0.5	Shutdown	5-Pin SOT-23A
TC1189	6.0	1.8, 2.8, 2.84, 3.15	120	-40 to +125	50	130	±0.5	Shutdown	5-Pin SOT-23A
TC2185	6.0	1.8, 2.7, 2.8, 3.0, 3.3	150	-40 to +125	55	140	±0.4	Shutdown, Reference bypass input	5-Pin SOT-23A
TC1185	6.0	1.8, 2.5, 2.7, 2.8, 2.85, 3.0, 3.3, 3.6, 4.0, 5.0	150	-40 to +125	50	270	±0.5	Shutdown, Reference bypass input	5-Pin SOT-23A
TC2186	6.0	1.8, 2.7, 2.8, 3.0, 3.3	150	-40 to +125	55	140	±0.4	Shutdown, Error output	5-Pin SOT-23A
TC1186	6.0	1.8, 2.5, 2.7, 2.8, 2.85, 3.0, 3.3, 3.6, 4.0, 5.0	150	-40 to +125	50	270	±0.5	Shutdown, Error output	5-Pin SOT-23A
TC1187	6.0	1.23 → V _{IN}	150	-40 to +125	50	270	—	Shutdown, Adjustable	5-Pin SOT-23A
TC1017	6.0	1.8, 2.6, 2.7, 2.8, 2.85, 2.9, 3.3, 3.4	150	-40 to +125	53	285	±0.5	Shutdown	5-Pin SOT-23A, 5-Pin SC-70
MCP1700	6.0	1.2, 1.8, 2.5, 3.0, 3.3, 5.0	250	-40 to +125	1.0	300	±0.4	1.0 µF ceramic cap stable, Short-circuit protection	3-Pin TO-92, 3-Pin SOT-23A, 3-Pin SOT-89
MCP1701	10	1.8, 2.5, 3.0, 3.3, 5.0	250	-40 to +85	1.1	380	±0.5	10V max. input voltage	3-Pin SOT-23A, 3-Pin SOT-89, 3-Pin TO-92

- NOTE**
- 1: Depending on external transistor configuration.
 - 2: Each channel (for Dual and Quad LDOs).
 - 3: LDOs with shutdown (except Power-Management Combination Products as indicated) have typical shutdown currents of 0.05 µA.

POWER MANAGEMENT – Linear Regulators

Part #	Max. Input Voltage (V)	Output Voltage (V)	Output Current (mA)	Junction Temperature Range (°C)	Typical Active Current (µA)	Typical Dropout Voltage @ Max. I _{OUT} (mV)	Typical Output Voltage Accuracy (%)	Features	Packages
300 mA Low Dropout Linear Regulators									
TC1107	6.0	2.5, 2.7, 2.8, 3.0, 3.3, 5.0	300	-40 to +125	50	240	±0.5	Shutdown, Reference bypass input	8-Pin MSOP, 8-Pin SOIC
TC1108	6.0	2.5, 2.7, 2.8, 3.0, 3.3, 5.0	300	-40 to +125	50	240	±0.5		3-Pin SOT-223
TC1173	6.0	2.5, 2.7, 2.8, 3.0, 3.3, 5.0	300	-40 to +125	50	240	±0.5	Shutdown, Reference bypass input, Error output	8-Pin MSOP, 8-Pin SOIC
TC1174	6.0	1.23 → V _{IN}	300	-40 to +125	50	240	—	Shutdown, Reference bypass input, Adjustable	8-Pin MSOP, 8-Pin SOIC
TC1269	6.0	2.5, 2.8, 3.0, 3.3, 5.0	300	-40 to +125	50	240	±0.5	Shutdown, Reference bypass input	8-Pin MSOP
500 mA to 800 mA Low Dropout Linear Regulators									
TC1262	6.0	2.5, 2.8, 3.0, 3.3, 5.0	500	-40 to +125	80	350	±0.5		3-Pin TO-220, 3-Pin DDPACK, 3-Pin SOT-223
TC1263	6.0	2.5, 2.8, 3.0, 3.3, 5.0	500	-40 to +125	80	350	±0.5	Shutdown, Reference bypass input, Error output	8-Pin SOIC, 5-Pin TO-220, 5-Pin DDPACK
TC1268	6.0	2.5	500	-40 to +125	80	350	±0.5	Shutdown, Reference bypass input, Error output	8-Pin SOIC
TC1264	6.0	1.8, 2.5, 3.0, 3.3	800	-40 to +125	80	450	±0.5		3-Pin TO-220, 3-Pin DDPACK, 3-Pin SOT-223
TC1265	6.0	1.8, 2.5, 3.0, 3.3	800	-40 to +125	80	450	±0.5	Shutdown, Reference bypass input, Error output	8-Pin SOIC, 5-Pin TO-220, 5-Pin DDPACK
TC2117	6.0	1.8, 2.5, 3.0, 3.3	800	-40 to +125	80	600	±0.5		3-Pin SOT-223, 3-Pin DDPACK
1A and Above Low Dropout Linear Regulators									
MCP1726	6.0	Fixed: 5, 3.3, 3, 2.5, 1.8, 1.2, 0.8 Adjustable: .8 to 5.0	1000	-40 to +125	140	300	±0.4	Ceramic output capacitor stable, Shutdown, C _{delay} , Power-Good	8-Pin 3x3 DFN, 8-Pin SOIC
Application Specific Low Dropout Linear Regulators									
TC1266	6.0	3.3	200	-5 to +70	230	200	±1.0	PCI compliant	8-Pin SOIC, 8-Pin MSOP
TC1267	6.0	3.3	400	-5 to +70	230	300	±1.0	PCI compliant	5-Pin DDPACK
TC57	8	2.5, 3.0, 3.3	4,000 ⁽¹⁾	-40 to +85	50	100 ⁽¹⁾	±2.0	Shutdown, External transistor	5-Pin SOT-23A
TC59	-10	-3.0, -5.0	100	-40 to +85	3	380	±0.5	Negative LDO	3-Pin SOT-23A
Power-Management Combination Products									
TC1300 ⁽³⁾	6.0	2.5, 2.7, 2.8, 2.85, 3.0, 3.3	300	-40 to +125	80	210	±0.5	Shutdown, Reference bypass input, LDO plus Reset output	8-Pin MSOP
TC1301A ⁽³⁾	6.0	LDO1: 1.5-3.3 LDO2: 1.5-3.3	LDO1: 300 LDO2: 150	-40 to +125	103	LDO1: 104 LDO2: 150	±0.5	Dual LDO plus Reset output, Shutdown, Reference bypass, Voltage detect	8-Pin MSOP, 8-Pin 3x3 DFN
TC1301B ⁽³⁾	6.0	LDO1: 1.5-3.3 LDO2: 1.5-3.3	LDO1: 300 LDO2: 150	-40 to +125	114	LDO1: 104 LDO2: 150	±0.5	Dual LDO plus Reset, Per channel output shutdown, Reference bypass	8-Pin MSOP, 8-Pin 3x3 DFN
TC1302A ⁽³⁾	6.0	LDO1: 1.5-3.3 LDO2: 1.5-3.3	LDO1: 300 LDO2: 150	-40 to +125	103	LDO1: 104 LDO2: 150	±0.5	Dual LDO, Output shutdown reference bypass, Voltage detect	8-Pin MSOP, 8-Pin 3x3 DFN

NOTE 1: Depending on external transistor configuration.
 2: Each channel (for Dual and Quad LDOs).
 3: LDOs with shutdown (except Power-Management Combination Products as indicated) have typical shutdown currents of 0.05 µA.

POWER MANAGEMENT – Linear Regulators

Part #	Max. Input Voltage (V)	Output Voltage (V)	Output Current (mA)	Junction Temperature Range (°C)	Typical Active Current (µA)	Typical Dropout Voltage @ Max. I _{out} (mV)	Typical Output Voltage Accuracy (%)	Features	Packages
Power-Management Combination Products (continued)									
TC1302B ⁽³⁾	6.0	LDO1: 1.5-3.3 LDO2: 1.5-3.3	LDO1: 300 LDO2: 150	-40 to +125	114	LDO1: 104 LDO2: 150	±0.5	Dual LDO, Per channel output shutdown, Reference bypass	8-Pin MSOP, 8-Pin 3x3 DFN
TC1305	6.0	2.5, 2.8, 3.0	150 ⁽²⁾	-40 to +125	120	240	±0.5	Dual LDO plus Reset output, Reference bypass input, Shutdown, Select Mode™ selectable output voltages	10-Pin MSOP
TC1306	6.0	1.8, 2.8, 3.0	150 ⁽²⁾	-40 to +125	120	240	±0.5	Dual LDO plus Reset output, Shutdown, Select Mode™ selectable output voltages	8-Pin MSOP
TC1307 ⁽³⁾	6.0	1.8, 2.5, 2.8, 3.0	150 ⁽²⁾	-40 to +125	220	200	±0.5	Quad LDO plus Reset output, Shutdown, Select Mode™ selectable output voltage	16-Pin QSOP

- NOTE**
- 1: Depending on external transistor configuration.
 - 2: Each channel (for Dual and Quad LDOs).
 - 3: LDOs with shutdown (except Power-Management Combination Products as indicated) have typical shutdown currents of 0.05 µA.

POWER MANAGEMENT – Switching Regulators

Part #	Description	Input Voltage Range (V)	Output Voltage (V)	Operating Temperature Range (°C)	Control Scheme	Switching Frequency (kHz)	Typical Active Current (µA)	Output Current (mA)	Features	Packages
MCP1601	Synchronous Buck Regulator	2.7 to 5.5	0.9V to V _{IN}	-40 to +85	PFM/PWM/LDO	750	825 (PWM) 125 (PFM)	500	UVLO, Auto-switching, LDO	8-Pin MSOP
MCP1612	Synchronous Buck DC/DC Regulator	2.7 to 5.5	0.8 to 5.5	-40 to +85	Constant frequency PWM	1400	10,000	1000	Overall efficiency >94% soft start, over-temperature and over-current protection	8-Pin MSOP, 8-Pin 3x3 DFN
MCP1650	Step-up DC/DC controller	2.7 to 5.5	2.5 to ext. tx limited	-40 to +125	Constant frequency, 2 fixed DC	750	120	560/440	2 duty cycles for min. and max. loads, shutdown control, UVLO, soft start	8-Pin MSOP
MCP1651	Step-up DC/DC controller	2.7 to 5.5	2.5 to ext. tx limited	-40 to +125	Constant frequency, 2 fixed DC	750	120	560/440	2 duty cycles for min. and max. loads, shutdown control, low battery detect, UVLO, soft start	8-Pin MSOP
MCP1652	Step-up DC/DC controller	2.7 to 5.5	2.5 to ext. tx limited	-40 to +125	Constant frequency, 2 fixed DC	750	120	560/440	2 duty cycles for min. and max. loads, shutdown control, power-good indicator, UVLO, soft start	8-Pin MSOP
MCP1653	Step-up DC/DC controller	2.7 to 5.5	2.5 to ext. tx limited	-40 to +125	Constant frequency, 2 fixed DC	750	120	560/440	2 duty cycles for min. and max. loads, shutdown control, low battery detect, power-good indicator, UVLO, soft start	10-Pin MSOP
TC105	Step-down DC/DC Controller	2.2 to 10	3.0, 3.3, 5.0	-40 to +85	PFM/PWM	300	57	1,000	Low-Power Shutdown mode	5-Pin SOT-23A
TC120	Step-down Regulator/Controller Combination	1.8 to 10	3.0, 3.3, 5.0	-40 to +85	PFM/PWM	300	52	2,000	Soft-start, Low-Power Shutdown mode	8-Pin SOP
TC125	Step-up DC/DC Regulator	0.9 to 10	3.0, 3.3, 5.0	-40 to +85	PFM	100	20	80	Low-Power Shutdown mode	5-Pin SOT-23A
TC126	Step-up DC/DC Regulator	0.9 to 10	3.0, 3.3, 5.0	-40 to +85	PFM	100	20	80	Feedback voltage sensing	5-Pin SOT-23A
TC115	Step-up DC/DC Regulator	0.9 to 10	3.0, 3.3, 5.0	-40 to +85	PFM/PWM	100	80	140	Feedback voltage sensing, Low-Power Shutdown mode	5-Pin SOT-89
TC110	Step-up DC/DC Controller	2.0 to 10	3.0, 3.3, 5.0	-40 to +85	PFM/PWM	100/300	50/120	300	Soft-start, Low-Power Shutdown mode	5-Pin SOT-23A

POWER MANAGEMENT – PWM Controllers

Part #	Description	Input Voltage Range (V)	Output Voltage (V)	Operating Temperature Range (°C)	Control Scheme	Switching Frequency (kHz)	Typical Active Supply (µA)	Output Current (mA)	Features	Packages
MCP1630	High speed PWM to use with PIC® MCUs	2.7 to 5.5	V _{SS} + 0.2V to V _{DD} - 0.2V	-40 to +125	Cycle-by-Cycle DC control	1000	3.5	±10	UVLO, current sense to V _{EXT} , response <25 ns	8-Pin MSOP

POWER MANAGEMENT – Charge Pump DC-to-DC Converters

Part #	Input Voltage Range (V)	Output Voltage (V)	Operating Temperature Range (°C)	Maximum Input Current ⁽¹⁾ (µA)	Typical Active Output Current (mA)	Features	Packages
Inverting or Doubling Charge Pumps							
TC1044S	1.5 to 12	V _{OUT} = -V _{IN} or V _{OUT} = 2 V _{IN}	-40 to +85	160	20	85 kHz oscillator, Boost mode	8-Pin PDIP, 8-Pin SOIC
TC7660	1.5 to 10	V _{OUT} = -V _{IN} or V _{OUT} = 2 V _{IN}	-40 to +85	180	20	10 kHz oscillator	8-Pin PDIP, 8-Pin SOIC
TC7660H	1.5 to 10	V _{OUT} = -V _{IN} or V _{OUT} = 2 V _{IN}	-40 to +85	1,000	20	120 kHz oscillator	8-Pin PDIP, 8-Pin SOIC
TC7660S	1.5 to 12	V _{OUT} = -V _{IN} or V _{OUT} = 2 V _{IN}	-40 to +85	160	20	45 kHz oscillator, Boost mode	8-Pin PDIP, 8-Pin SOIC
TC7662B	1.5 to 15	V _{OUT} = -V _{IN} or V _{OUT} = 2 V _{IN}	-40 to +85	180	20	35 kHz oscillator, Boost mode	8-Pin PDIP, 8-Pin SOIC
TC1219	1.5 to 5.5	V _{OUT} = -V _{IN} or V _{OUT} = 2 V _{IN}	-40 to +85	115	25	12 kHz oscillator, Low-Power Shutdown mode	6-Pin SOT-23A
TC1220	1.5 to 5.5	V _{OUT} = -V _{IN} or V _{OUT} = 2 V _{IN}	-40 to +85	325	25	35 kHz oscillator, Low-Power Shutdown mode	6-Pin SOT-23A
TC1221	1.8 to 5.5	V _{OUT} = -V _{IN} or V _{OUT} = 2 V _{IN}	-40 to +85	600	25	Shutdown, 125 kHz oscillator	6-Pin SOT-23A
TC1222	1.8 to 5.5	V _{OUT} = -V _{IN} or V _{OUT} = 2 V _{IN}	-40 to +85	2,800	25	Shutdown, 750 kHz oscillator	6-Pin SOT-23A
TCM828	1.5 to 5.5	V _{OUT} = -V _{IN} or V _{OUT} = 2 V _{IN}	-40 to +85	90	25	12 kHz oscillator	5-Pin SOT-23A
TCM829	1.5 to 5.5	V _{OUT} = -V _{IN} or V _{OUT} = 2 V _{IN}	-40 to +85	260	25	35 kHz oscillator	5-Pin SOT-23A
TC1240	2.5 to 4.0	V _{OUT} = 2 V _{IN}	-40 to +85	900	40	Shutdown, 160 kHz oscillator	6-Pin SOT-23A
TC1240A	2.5 to 5.5	V _{OUT} = 2 V _{IN}	-40 to +85	900	40	Shutdown, 160 kHz oscillator	6-Pin SOT-23A
TC7662A	3 to 18	V _{OUT} = -V _{IN} or V _{OUT} = 2V _{IN}	-40 to +85	200	40	12 kHz oscillator	8-Pin PDIP
TC962	3 to 18	V _{OUT} = -V _{IN} or V _{OUT} = 2 V _{IN}	-40 to +85	200	80		8-Pin PDIP, 16-Pin SOIC
TC1121	2.4 to 5.5	V _{OUT} = -V _{IN} or V _{OUT} = 2 V _{IN}	-40 to +85	100	100	Low-Power Shutdown mode	8-Pin MSOP, 8-Pin PDIP, 8-Pin SOIC
Multi-Function Charge Pumps							
TCM680	2.0 to 5.5	V _{OUT} = ±2 V _{IN}	-40 to +85	1,000	±10	Generates ±6V from +3V or ±10V from +5V	8-Pin PDIP, 8-Pin SOIC
Inverting and Doubling Charge Pumps							
TC682	2.4 to 5.5	V _{OUT} = -2 V _{IN}	-40 to +85	400	10	12 kHz oscillator	8-Pin PDIP, 8-Pin SOIC
Regulated Charge Pumps							
TC1142	2.5 to 5.5	-3V to -5V	-40 to +85	400	20	Regulated GaAs FET supply, Internal 200 kHz oscillator, External clock 3 kHz to 500 kHz, Low-Power Shutdown mode	8-Pin MSOP
MCP1252	2.1/2.7 to 5.5 2.0 to 5.5	Selectable 3.3V or 5.0V or Adjustable 1.5V to 5.5V	-40 to +85	120	120 mA for V _{IN} >3.0V	Power-Good output, 650 kHz oscillator	8-Pin MSOP
MCP1253	2.1/2.7 to 5.5 2.0 to 5.5	Selectable 3.3V or 5.0V or Adjustable 1.5V to 5.5V	-40 to +85	120	120 mA for V _{IN} >3.0V	Power-Good output, 1 MHz oscillator	8-Pin MSOP

NOTE 1: Measured at V_{DD} = 5.0V at 25°C and no load.

POWER MANAGEMENT – CPU/System Supervisors

Part #	Vcc Range (V)	Operating Temperature Range (°C)	Nominal Reset Voltage (V)	Reset Type	Output	Typical Reset Pulse Width (ms)	Typical Supply Current (µA)	Additional Features	Packages	Bond Options
MCP102	1.0-5.5	-40 to 125	1.9, 2.32, 2, 63, 2.93, 3.08, 4.38, 4.63	Active Low	CMOS Push-Pull	120	1		3-Pin SOT-23B, 3-Pin SC-70, 3-Pin TO-92	N/A
MCP103	1.0-5.5	-40 to 125	1.9, 2.32, 2, 63, 2.93, 3.08, 4.38, 4.63	Active Low	CMOS Push-Pull	120	1	Max. 809 Pinout	3-Pin SOT-23B, 3-Pin SC-70, 3-Pin TO-92	N/A
TC1272	1.2-5.5	-40 to +85	4.62, 4.37, 4.12	Active Low	CMOS Push-Pull	200	17		3-Pin SOT-23B	N/A
TC1275	1.2-5.5	-40 to +85	3.06, 2.88, 2.55	Active Low	CMOS Push-Pull	200	20		3-Pin SOT-23B	N/A
TCM809	1.2-5.5	-40 to +85	4.63, 4.38, 4.00, 3.08, 2.93, 2.63, 2.32	Active Low	CMOS Push-Pull	240	12		3-Pin SOT-23B, 3-Pin SC-70	N/A
TC1270	1.2-5.5	-40 to +85	4.63, 4.38, 3.08, 2.93, 2.63, 1.75	Active Low	CMOS Push-Pull	280	7	Manual Reset	4-Pin SOT-143	N/A
TCM811	1.0-5.5	-40 to +85	4.63, 4.38, 3.08, 2.93, 2.63, 1.75	Active Low	CMOS Push-Pull	280	6	Manual Reset	4-Pin SOT-143	N/A
MCP100	1.0-5.5	-40 to +85	4.72, 4.62, 4.47, 4.37, 3.075, 2.92, 2.62	Active Low	CMOS Push-Pull	350	45		3-Pin TO-92, 3-Pin SOT-23B	D, H
MCP809	1.0-5.5	-40 to +85	4.72, 4.62, 4.47, 4.37, 3.075, 2.92, 2.62	Active Low	CMOS Push-Pull	350	45		3-Pin SOT-23B	N/A
TC1274	1.8-5.5	-40 to +85	4.62, 4.37, 4.13	Active High	CMOS Push-Pull	200	17		3-Pin SOT-23B	N/A
TC1277	1.8-5.5	-40 to +85	3.06, 2.88, 2.55	Active High	CMOS Push-Pull	200	20		3-Pin SOT-23B	N/A
TCM810	1.2-5.5	-40 to +85	4.63, 4.38, 3.08, 2.93, 2.63, 2.32	Active High	CMOS Push-Pull	240	12		3-Pin SOT-23B, 3-Pin SC-70	N/A
TC1271	1.2-5.5	-40 to +85	4.63, 4.38, 3.08, 2.93, 2.63, 1.75	Active High	CMOS Push-Pull	280	7	Manual Reset	4-Pin SOT-143	N/A
TCM812	1.1-5.5	-40 to +85	4.63, 4.38, 3.08, 2.93, 2.63, 1.75	Active High	CMOS Push-Pull	280	6	Manual Reset	4-Pin SOT-143	N/A
MCP101	1.0-5.5	-40 to +85	4.72, 4.62, 4.47, 4.37, 3.075, 2.92, 2.62	Active High	CMOS Push-Pull	350	45		3-Pin TO-92, 3-Pin SOT-23B	D, H
MCP810	1.0-5.5	-40 to +85	4.72, 4.62, 4.47, 4.37, 3.075, 2.92, 2.62	Active High	CMOS Push-Pull	350	45		3-Pin SOT-23B	N/A
MCP121	1.0-5.5	-40 to 125	1.9, 2.32, 2, 63, 2.93, 3.08, 4.38, 4.63	Active Low	Open-drain	120	1		3-Pin SOT-23B, 3-Pin SC-70, 3-Pin TO-92	N/A
TC1273	1.2-5.5	-40 to +85	4.62, 4.37, 4.12	Active Low	Open-drain	200	17		3-Pin SOT-23B	N/A
TC1276	1.2-5.5	-40 to +85	3.06, 2.88, 2.55	Active Low	Open-drain	200	20		3-Pin SOT-23B	N/A
MCP120	1.0-5.5	-40 to +85	4.72, 4.62, 4.47, 4.37, 3.075, 2.92, 2.62	Active Low	Open-drain	350	45		3-Pin TO-92, 3-Pin SOT-23, 8-Pin SOIC	D, G, H
TC1279	1.2-5.5	-40 to +85	4.62, 4.37, 4.125	Active Low	Open-drain	350	900		3-Pin SOT-23B	N/A
MCP131	1.0-5.5	-40 to 125	1.9, 2.32, 2, 63, 2.93, 3.08, 4.38, 4.63	Active Low	Open-drain	120	1	100kΩ Internal Pull-up Resistor	3-Pin SOT-23B, 3-Pin SC-70, 3-Pin TO-92	N/A
MCP130	1.0-5.5	-40 to +85	4.72, 4.62, 4.47, 4.37, 3.075, 2.92, 2.62	Active Low	Open-drain w/ 5 kΩ Pull-up	350	45		3-Pin TO-92, 3-Pin SOT-23, 8-Pin SOIC	D, F, H
TC1278	1.2-5.5	-40 to +85	4.62, 4.37, 4.125	Active High	Open-drain	350	900		3-Pin SOT-23B	N/A
TC1232	4.5-5.5	-40 to +85	4.62, 4.37	Active Low/High	Open-drain	610	50	Watchdog Timer	8-Pin PDIP, 8-Pin SOIC, 16-Pin SOIC	N/A
TC32M	4.5-5.5	-40 to +85	4.5	Active Low	Open-drain	700	50	Watchdog Timer	3-Pin TO-92, 3-Pin SOT-223	N/A

POWER MANAGEMENT – Voltage Detectors

Part #	Vcc Range (V)	Operating Temperature Range (°C)	Nominal Reset Voltage (V)	Reset Type	Output	Minimum Reset Pulse Width (ms)	Typical Supply Current (µA)	Features	Packages
MCP111	1.0 to 5.5	-40 to +125	4.63, 4.38, 3.08, 2.93, 2.63, 2.32, 1.90	Active Low	Open-drain	—	1		3-Pin SOT-23B, 3-Pin TO-92, 3-Pin SC-70, 3-Pin SOT-89
MCP112	1.0 to 5.5	-40 to +125	4.63, 4.38, 3.08, 2.93, 2.63, 2.32, 1.90	Active Low	CMOS Push-Pull	—	1		3-Pin SOT-23B, 3-Pin TO-92, 3-Pin SC-70, 3-Pin SOT-89
TC51	0.7 to 10	-40 to +85	3.0, 2.7, 2.2	Active Low	Open-drain	50	1	Reset delay	3-Pin SOT-23A
TC52	1.5 to 10	-40 to +85	4.5/2.7, 3.0/2.7	Active Low	Open-drain	—	2	Dual channel	5-Pin SOT-23A
TC53	1.5 to 10	-40 to +85	2.9, 2.7, 2.2	Active Low	CMOS Push-Pull or Open-drain	—	1		5-Pin SOT-23A
TC54	0.7 to 10	-40 to +85	7.7, 4.3, 4.2, 3.0, 2.9, 2.7, 2.1, 1.4	Active Low	CMOS Push-Pull or Open-drain	—	1		3-Pin SOT-23A, 3-Pin SOT-89, 3-Pin TO-92

POWER MANAGEMENT – Power MOSFET Drivers

Part #	Configuration	Operating Temperature Range (°C)	Peak Output Current (A)	Output Resistance (RH/RL) (Max. Ω @ 25°C)	Max. Supply Voltage (V)	Input/Output Delay (td1, td2) ⁽¹⁾ (ns)	Packages
Low-Side Drivers, 0.5A to 1.2A Peak Output Current							
TC1410	Single, Inverting	-40 to +85	0.5	22/22	16	30/30	8-Pin PDIP, 8-Pin SOIC, 8-Pin MSOP
TC1410N	Single, Non-inverting	-40 to +85	0.5	22/22	16	30/30	8-Pin PDIP, 8-Pin SOIC, 8-Pin MSOP
TC1411	Single, Inverting	-40 to +85	1	11/11	16	30/30	8-Pin PDIP, 8-Pin SOIC, 8-Pin MSOP
TC1411N	Single, Non-inverting	-40 to +85	1	11/11	16	30/30	8-Pin PDIP, 8-Pin SOIC, 8-Pin MSOP
TC1426	Dual, Inverting	0 to +70	1.2	18/18	16	75/75	8-Pin PDIP, 8-Pin SOIC
TC1427	Dual, Non-inverting	0 to +70	1.2	18/18	16	75/75	8-Pin PDIP, 8-Pin SOIC
TC1428	Dual, Inverting and Non-inverting	0 to +70	1.2	18/18	16	75/75	8-Pin PDIP, 8-Pin SOIC
TC4467	Quad, Inverting	-40 to +85	1.2	15/15	18	40/40	14-Pin PDIP, 16-Pin SOIC (W)
TC4468	Quad, Non-inverting	-40 to +85	1.2	15/15	18	40/40	14-Pin PDIP, 16-Pin SOIC (W)
TC4469	Quad, Non-inverting	-40 to +85	1.2	15/15	18	40/40	14-Pin PDIP, 16-Pin SOIC (W)
Low-Side Drivers, 1.5A Peak Output Current							
TC4403	Single, Non-inverting Floating Load Driver	-40 to +85	1.5	5/5	18	33/38	8-Pin PDIP
TC4426A	Dual, Inverting	-40 to +125	1.5	9/9	18	30/30	8-Pin PDIP, 8-Pin SOIC, 8-Pin DFN
TC4427A	Dual, Non-inverting	-40 to +125	1.5	9/9	18	30/30	8-Pin PDIP, 8-Pin SOIC, 8-Pin DFN
TC4428A	Dual, Inverting and Non-inverting	-40 to +125	1.5	9/9	18	30/30	8-Pin PDIP, 8-Pin SOIC, 8-Pin DFN
TC4426	Dual, Inverting	-40 to +125	1.5	10/10	18	20/40	8-Pin PDIP, 8-Pin SOIC, 8-Pin DFN, 8-Pin MSOP
TC4427	Dual, Non-inverting	-40 to +125	1.5	10/10	18	20/40	8-Pin PDIP, 8-Pin SOIC, 8-Pin DFN, 8-Pin MSOP
TC4428	Dual, Inverting and Non-inverting	-40 to +125	1.5	10/10	18	20/40	8-Pin PDIP, 8-Pin SOIC, 8-Pin DFN, 8-Pin MSOP

NOTE 1: *td1 = delay time from input low-to-high transition to output transition. td2 = delay time from input high-to-low transition to output transition.

POWER MANAGEMENT – Power MOSFET Drivers

Part #	Configuration	Operating Temperature Range (°C)	Peak Output Current (A)	Output Resistance (RH/RL) (Max. Ω @ 25°C)	Max. Supply Voltage (V)	Input/Output Delay (td1, td2) ⁽¹⁾ (ns)	Packages
Low-Side Drivers, 1.5A Peak Output Current (continued)							
TC426	Dual, Inverting	-40 to +85	1.5	15/10	18	50/75	8-Pin PDIP, 8-Pin SOIC
TC427	Dual, Non-inverting	-40 to +85	1.5	15/10	18	50/75	8-Pin PDIP, 8-Pin SOIC
TC428	Dual, Inverting and Non-inverting	-40 to +85	1.5	15/10	18	50/75	8-Pin PDIP, 8-Pin SOIC
TC4404	Dual, Inverting	-40 to +85	1.5	10/10	18	15/32	8-Pin PDIP, 8-Pin SOIC
TC4405	Dual, Non-inverting	-40 to +85	1.5	10/10	18	15/32	8-Pin PDIP, 8-Pin SOIC
Low-Side Drivers, 2.0A to 9.0A Peak Output Current							
TC1412	Single, Inverting	-40 to +85	2	6/6	16	35/35	8-Pin PDIP, 8-Pin SOIC, 8-Pin MSOP
TC1412N	Single, Non-inverting	-40 to +85	2	6/6	16	35/35	8-Pin PDIP, 8-Pin SOIC, 8-Pin MSOP
TC1413	Single, Inverting	-40 to +85	3	4/4	16	35/35	8-Pin PDIP, 8-Pin SOIC, 8-Pin MSOP
TC1413N	Single, Non-inverting	-40 to +85	3	4/4	16	35/35	8-Pin PDIP, 8-Pin SOIC, 8-Pin MSOP
TC4423	Dual, Inverting	-40 to +125	3	5/5	18	33/38	8-Pin PDIP, 16-Pin SOIC (W), 8-Pin DFN
TC4424	Dual, Non-inverting	-40 to +125	3	5/5	18	33/38	8-Pin PDIP, 16-Pin SOIC (W), 8-Pin DFN
TC4425	Dual, Inverting and Non-inverting	-40 to +125	3	5/5	18	33/38	8-Pin PDIP, 16-Pin SOIC (W), 8-Pin DFN
TC429	Single, Inverting	-40 to +85	6	2.5/2.5	18	53/60	8-Pin PDIP, 8-Pin DFN, 8-Pin SOIC
TC4420	Single, Non-inverting	-40 to +125	6	2.8/2.5	18	55/55	8-Pin PDIP, 8-Pin SOIC, 5-Pin TO-220, 8-Pin DFN
TC4429	Single, Inverting	-40 to +125	6	2.8/2.5	18	55/55	8-Pin PDIP, 8-Pin SOIC, 5-Pin TO-220, 8-Pin DFN
TC4421	Single, Inverting	-40 to +125	9	1.4 (typ)/1.7	18	30/33	8-Pin PDIP, 5-Pin TO-220, 8-Pin DFN
TC4422	Single, Non-inverting	-40 to +125	9	1.4 (typ)/1.7	18	30/33	8-Pin PDIP, 5-Pin TO-220, 8-Pin DFN
High-Side/Low-Side Drivers							
TC4626	Single, Inverting	-40 to +85	1.5	15/10	6	35/45	8-Pin PDIP, 16-Pin SOIC (W)
TC4627	Single, Non-inverting	-40 to +85	1.5	15/10	6	35/45	8-Pin PDIP, 16-Pin SOIC (W)
TC4431	Single, Inverting	-40 to +85	1.5	10/10	30	62/78	8-Pin PDIP, 8-Pin SOIC
TC4432	Single, Non-inverting	-40 to +85	1.5	10/10	30	62/78	8-Pin PDIP, 8-Pin SOIC

NOTE 1: *td1 = delay time from input low-to-high transition to output transition. td2 = delay time from input high-to-low transition to output transition.

POWER MANAGEMENT – Battery Chargers

Part #	Mode	Cell Type	# of Cells	Vcc Range (V)	Max. Voltage Regulation (%)	Int/Ext FET	Features	Packages
MCP73826	Linear	Li Ion/Li Polymer	1	4.5 to 5.5	±1.0	Ext	Small size	6-Pin SOT-23
MCP73827	Linear	Li Ion/Li Polymer	1	4.5 to 5.5	±1.0	Ext	Mode indicator, Charge Current monitor	8-Pin MSOP
MCP73828	Linear	Li Ion/Li Polymer	1	4.5 to 5.5	±1.0	Ext	Temperature monitor	8-Pin MSOP
MCP73841	Linear	Li Ion/Li Polymer	1	4.5 to 12	±0.5	Ext	Safety charge timers, Temperature monitor	10-Pin MSOP
MCP73842	Linear	Li Ion/Li Polymer	2	8.7 to 12	±0.5	Ext	Safety charge timers, Temperature monitor	10-Pin MSOP
MCP73843	Linear	Li Ion/Li Polymer	1	4.5 to 12	±0.5	Ext	Safety charge timers	8-Pin MSOP
MCP73844	Linear	Li Ion/Li Polymer	2	8.7 to 12	±0.5	Ext	Safety charge timers	8-Pin MSOP
MCP73853	Linear	Li-Ion/Li-Polymer	1	4.5 to 5.5	±0.5	Int	USB control, safety charge timers, temperature monitor, thermal regulation	16-Pin QFN (4x4)
MCP73855	Linear	Li-Ion/Li-Polymer	1	4.5 to 5.5	±0.5	Int	USB control, safety charge timers, thermal regulation	10-Pin DFN (3x3)
MCP73861	Linear	Li Ion/Li Polymer	1	4.5 to 12	±0.5	Int	Safety charge timers, Temperature monitor, Thermal regulation	16-pin 4x4 QFN
MCP73862	Linear	Li Ion/Li Polymer	2	8.7 to 12	±0.5	Int	Safety charge timers, Temperature monitor, Thermal regulation	16-pin 4x4 QFN

POWER MANAGEMENT – Hot Swap Controllers

Part #	Number of Outputs	Vpos to Vneg Differential Voltage (V)	Junction Temperature Range (°C)	OVLO	UVLO	Power Good	Int/Ext FET	Applications	Packages
MCP18480	1	-0.3 to +15.0	-40 to +85	Adjustable	Adjustable	Adjustable	Ext	-48V Telecom/Datacom, Bus/Backplane	20-Pin SSOP

LINEAR – Op Amps

Part #	# per Package	GBWP	Iq Typical (µA)	Vos Max (mV)	Input Voltage Noise Density (nV/rtHz)	Operating Voltage (V)	Temp. Range (°C)	Features	Packages
TC1034	1	90 kHz	6	1.5	125 ⁽¹⁾	1.8 to 5.5	-40 to +85	Rail-to-Rail Input/Output	5-Pin SOT-23A
TC1035	1	90 kHz	6	1.5	125 ⁽¹⁾	1.8 to 5.5	-40 to +85	Rail-to-Rail Input/Output, Shutdown pin	6-Pin SOT-23A
TC1029	2	90 kHz	6	1.5	125 ⁽¹⁾	1.8 to 5.5	-40 to +85	Rail-to-Rail Input/Output	8-Pin PDIP, 8-Pin MSOP, 8-Pin SOIC
TC1030	4	90 kHz	5	1.5	125 ⁽¹⁾	1.8 to 5.5	-40 to +85	Rail-to-Rail Input/Output, Shutdown pins	16-Pin QSOP
MCP6041	1	14 kHz	0.6	3	170 ⁽¹⁾	1.4 to 5.5	-40 to +85	Rail-to-Rail Input/Output	8-Pin PDIP, 8-Pin SOIC, 8-Pin MSOP, 5-Pin SOT-23
MCP6042	2	14 kHz	0.6	3	170 ⁽¹⁾	1.4 to 5.5	-40 to +85	Rail-to-Rail Input/Output	8-Pin PDIP, 8-Pin SOIC, 8-Pin MSOP
MCP6043	1	14 kHz	0.6	3	170 ⁽¹⁾	1.4 to 5.5	-40 to +85	Rail-to-Rail Input/Output, Chip Select	8-Pin PDIP, 8-Pin SOIC, 8-Pin MSOP
MCP6044	4	14 kHz	0.6	3	170 ⁽¹⁾	1.4 to 5.5	-40 to +85	Rail-to-Rail Input/Output	14-Pin PDIP, 14-Pin SOIC, 14-Pin TSSOP

NOTE 1: Values are typical at 1 KHz
 2: Values are typical at 10 KHz

LINEAR – Op Amps

Part #	# per Package	GBWP	I _Q Typical (μA)	V _{OS} Max (mV)	Input Voltage Noise Density (nV/rtHz)	Operating Voltage (V)	Temp. Range (°C)	Features	Packages
MCP6141	1	100 kHz	0.6	3	170 ⁽¹⁾	1.4 to 5.5	-40 to +85	Rail-to-Rail Input/Output, G>10 stable	8-Pin PDIP, 8-Pin SOIC, 8-Pin MSOP
MCP6142	2	100 kHz	0.6	3	170 ⁽¹⁾	1.4 to 5.5	-40 to +85	Rail-to-Rail Input/Output, G>10 stable	8-Pin PDIP, 8-Pin SOIC, 8-Pin MSOP
MCP6143	1	100 kHz	0.6	3	170 ⁽¹⁾	1.4 to 5.5	-40 to +85	Rail-to-Rail Input/Output, G>10 stable, Chip Select	8-Pin PDIP, 8-Pin SOIC, 8-Pin MSOP
MCP6144	4	100 kHz	0.6	3	170 ⁽¹⁾	1.4 to 5.5	-40 to +85	Rail-to-Rail Input/Output, G>10 stable	14-Pin PDIP, 14-Pin SOIC, 14-Pin TSSOP
MCP606	1	155 kHz	19	0.25	38 ⁽¹⁾	2.5 to 5.5	-40 to +85	Rail-to-Rail Output	8-Pin PDIP, 8-Pin SOIC, 8-Pin TSSOP, 5-Pin SOT23
MCP607	2	155 kHz	19	0.25	38 ⁽¹⁾	2.5 to 5.5	-40 to +85	Rail-to-Rail Output	8-Pin PDIP, 8-Pin SOIC, 8-Pin TSSOP
MCP608	1	155 kHz	19	0.25	38 ⁽¹⁾	2.5 to 5.5	-40 to +85	Rail-to-Rail Output, Chip Select	8-Pin PDIP, 8-Pin SOIC, 8-Pin TSSOP
MCP609	4	155 kHz	19	0.25	38 ⁽¹⁾	2.5 to 5.5	-40 to +85	Rail-to-Rail Output	14-Pin PDIP, 14-Pin SOIC, 14-Pin TSSOP
MCP616	1	190 kHz	19	0.15	32 ⁽¹⁾	2.3 to 5.5	-40 to +85	Rail-to-Rail Output, PNP Input	8-Pin PDIP, 8-Pin SOIC, 8-Pin MSOP
MCP617	2	190 kHz	19	0.15	32 ⁽¹⁾	2.3 to 5.5	-40 to +85	Rail-to-Rail Output, PNP	8-Pin PDIP, 8-Pin SOIC, 8-Pin MSOP
MCP618	1	190 kHz	19	0.15	32 ⁽¹⁾	2.3 to 5.5	-40 to +85	Rail-to-Rail Output, Chip Select, PNP Input	8-Pin PDIP, 8-Pin SOIC, 8-Pin MSOP
MCP619	4	190 kHz	19	0.15	32 ⁽¹⁾	2.3 to 5.5	-40 to +85	Rail-to-Rail Output, PNP Input	14-Pin PDIP, 14-Pin SOIC, 14-Pin TSSOP
MCP6231	1	300 kHz	20	7	52 ⁽¹⁾	1.8 to 5.5	-40 to +125	Rail-to-Rail Input/Output	5-Pin SC-70, 5-Pin SOT-23, 8-Pin PDIP, 8-Pin SOIC, 8-Pin MSOP
MCP6232	2	300 kHz	20	7	52 ⁽¹⁾	1.8 to 5.5	-40 to +125	Rail-to-Rail Input/Output	8-Pin PDIP, 8-Pin SOIC, 8-Pin MSOP
MCP6241	1	650 kHz	50	7	45 ⁽¹⁾	1.8 to 5.5	-40 to +125	Rail-to-Rail Input/Output	5-Pin SC-70, 5-Pin SOT-23, 8-Pin PDIP, 8-Pin SOIC, 8-Pin MSOP
MCP6242	2	650 kHz	50	7	45 ⁽¹⁾	1.8 to 5.5	-40 to +125	Rail-to-Rail Input/Output	8-Pin PDIP, 8-Pin SOIC, 8-Pin MSOP
MCP6001	1	1 MHz	140	4.5	28 ⁽¹⁾	1.8 to 5.5	-40 to +125	Rail-to-Rail Input/Output	5-Pin SOT-23, 5-Pin SC-70
MCP6002	2	1 MHz	140	4.5	28 ⁽¹⁾	1.8 to 5.5	-40 to +125	Rail-to-Rail Input/Output	8-Pin PDIP, 8-Pin SOIC, 8-Pin MSOP
MCP6004	4	1 MHz	140	4.5	28 ⁽¹⁾	1.8 to 5.5	-40 to +125	Rail-to-Rail Input/Output	14-Pin PDIP, 14-Pin SOIC, 14-Pin TSSOP
MCP6271	1	2 MHz	170	3	20 ⁽¹⁾	2.0 to 5.5	-40 to +125	Rail-to-Rail Input/Output	8-Pin PDIP, 8-Pin SOIC, 8-Pin MSOP
MCP6272	2	2 MHz	170	3	20 ⁽¹⁾	2.0 to 5.5	-40 to +125	Rail-to-Rail Input/Output	8-Pin PDIP, 8-Pin SOIC, 8-Pin MSOP
MCP6273	1	2 MHz	170	3	20 ⁽¹⁾	2.0 to 5.5	-40 to +125	Rail-to-Rail Input/Output, Chip Select	8-Pin PDIP, 8-Pin SOIC, 8-Pin MSOP
MCP6274	4	2 MHz	170	3	20 ⁽¹⁾	2.0 to 5.5	-40 to +125	Rail-to-Rail Input/Output	14-Pin PDIP, 14-Pin SOIC, 14-Pin TSSOP
MCP6275	2	2 MHz	150	3	20 ⁽¹⁾	2.0 to 5.5	-40 to +125	Rail-to-Rail Input/Output, Dual connected, Chip Select	8-Pin PDIP, 8-Pin SOIC, 8-Pin MSOP
MCP601	1	2.8 MHz	230	2	29 ⁽¹⁾	2.7 to 5.5	-40 to +125	Rail-to-Rail Output	8-Pin PDIP, 8-Pin SOIC, 8-Pin TSSOP, 5-Pin SOT-23
MCP602	2	2.8 MHz	230	2	29 ⁽¹⁾	2.7 to 5.5	-40 to +125	Rail-to-Rail Output	8-Pin PDIP, 8-Pin SOIC, 8-Pin TSSOP

NOTE 1: Values are typical at 1 KHz
NOTE 2: Values are typical at 10 KHz

LINEAR – Op Amps

Part #	# per Package	GBWP	I _Q Typical (μA)	V _{OS} Max (mV)	Input Voltage Noise Density (nV/rtHz)	Operating Voltage (V)	Temp. Range (°C)	Features	Packages
MCP603	1	2.8 MHz	230	2	29 ⁽¹⁾	2.7 to 5.5	-40 to +125	Rail-to-Rail Output, Chip Select	8-Pin PDIP, 8-Pin SOIC, 8-Pin TSSOP
MCP604	4	2.8 MHz	230	2	29 ⁽¹⁾	2.7 to 5.5	-40 to +125	Rail-to-Rail Output	14-Pin PDIP, 14-Pin SOIC, 14-Pin TSSOP
MCP6281	1	5 MHz	445	3	16 ⁽¹⁾	2.2 to 5.5	-40 to +125	Rail-to-Rail Input/Output	8-Pin PDIP, 8-Pin SOIC, 8-Pin MSOP
MCP6282	2	5 MHz	445	3	16 ⁽¹⁾	2.2 to 5.5	-40 to +125	Rail-to-Rail Input/Output	8-Pin PDIP, 8-Pin SOIC, 8-Pin MSOP
MCP6283	1	5 MHz	445	3	16 ⁽¹⁾	2.2 to 5.5	-40 to +125	Rail-to-Rail Input/Output, Chip Select	8-Pin PDIP, 8-Pin SOIC, 8-Pin MSOP
MCP6284	4	5 MHz	445	3	16 ⁽¹⁾	2.2 to 5.5	-40 to +125	Rail-to-Rail Input/Output	14-Pin PDIP, 14-Pin SOIC, 14-Pin TSSOP
MCP6285	2	5 MHz	400	3	16 ⁽¹⁾	2.2 to 5.5	-40 to +125	Rail-to-Rail Input/Output, Dual connected, Chip Select	8-Pin PDIP, 8-Pin SOIC, 8-Pin MSOP
MCP6291	1	10 MHz	1000	3	8.7 ⁽²⁾	2.4 to 5.5	-40 to +125	Rail-to-Rail Input/Output	8-Pin PDIP, 8-Pin SOIC, 8-Pin MSOP
MCP6292	2	10 MHz	1000	3	8.7 ⁽²⁾	2.4 to 5.5	-40 to +125	Rail-to-Rail Input/Output	8-Pin PDIP, 8-Pin SOIC, 8-Pin MSOP
MCP6293	1	10 MHz	1000	3	8.7 ⁽²⁾	2.4 to 5.5	-40 to +125	Rail-to-Rail Input/Output, Chip Select	8-Pin PDIP, 8-Pin SOIC, 8-Pin MSOP
MCP6294	4	10 MHz	1000	3	8.7 ⁽²⁾	2.4 to 5.5	-40 to +125	Rail-to-Rail Input/Output	14-Pin PDIP, 14-Pin SOIC, 14-Pin TSSOP
MCP6295	2	10 MHz	1100	3	8.7 ⁽²⁾	2.4 to 5.5	-40 to +125	Rail-to-Rail Input/Output, Dual connected, Chip Select	8-Pin PDIP, 8-Pin SOIC, 8-Pin MSOP
MCP6021	1	10 MHz	1000	0.5	8.7 ⁽²⁾	2.5 to 5.5	-40 to +125	Rail-to-Rail Input/Output, 1/2 V _{CC} V _{REF}	8-Pin PDIP, 8-Pin SOIC, 8-Pin TSSOP
MCP6022	2	10 MHz	1000	0.5	8.7 ⁽²⁾	2.5 to 5.5	-40 to +125	Rail-to-Rail Input/Output	8-Pin PDIP, 8-Pin SOIC, 8-Pin TSSOP
MCP6023	1	10 MHz	1000	0.5	8.7 ⁽²⁾	2.5 to 5.5	-40 to +125	Rail-to-Rail Input/Output, Chip Select	8-Pin PDIP, 8-Pin SOIC, 8-Pin TSSOP
MCP6024	4	10 MHz	1000	0.5	8.7 ⁽²⁾	2.5 to 5.5	-40 to +125	Rail-to-Rail Input/Output	14-Pin PDIP, 14-Pin SOIC, 14-Pin TSSOP

NOTE 1: Values are typical at 1 KHz
 2: Values are typical at 10 KHz

LINEAR – High Precision Operational Amplifiers

Part #	# per Package	GBWP	I _Q MAX (mA)	Typical V _{OS} (μV)	V _{OS} Drift Max (μV/°C)	Operating Voltage (V)	Temp. Range (°C)	Features	Packages
Chopper Stabilized									
TC7650	1	2.0 MHz	3.5	5	0.05	4.5 to 16	0 to 70	Single and Split Supply	8-Pin PDIP, 14-Pin PDIP
TC7652	1	0.4 MHz	3	5	0.05	5 to 16	0 to 70	Single and Split Supply, Low Noise	8-Pin PDIP, 14-Pin PDIP
Auto-Zero									
TC913	2	1.5 MHz	1.1	15	0.15	6.5 to 16	0 to 70	Single and Split Supply	8-Pin PDIP, 8-Pin SOIC

LINEAR – Programmable Gain Amplifiers (PGA)

Part #	Channels	-3dB BW (MHz)	Iq Typ.	Vos (μ V)	Operating Voltage (V)	Temp. Range ($^{\circ}$ C)	Features	Packages
MCP6S21	1	2 to 12	1.1 mA	275	2.5 to 5.5	-40 to +85	SPI, 8 Gain Steps, Software Shutdown	8-Pin PDIP, 8-Pin SOIC, 8-Pin MSOP
MCP6S22	2	2 to 12	1.1 mA	275	2.5 to 5.5	-40 to +85	SPI, 8 Gain Steps, Software Shutdown	8-Pin PDIP, 8-Pin SOIC, 8-Pin MSOP
MCP6S26	6	2 to 12	1.1 mA	275	2.5 to 5.5	-40 to +85	SPI, 8 Gain Steps, Software Shutdown	14-Pin PDIP, 14-Pin SOIC, 14-Pin TSSOP
MCP6S28	8	2 to 12	1.1 mA	275	2.5 to 5.5	-40 to +85	SPI, 8 Gain Steps, Software Shutdown	16-Pin PDIP, 16-Pin SOIC
MCP6S91	1	1 to 18	1.0 mA	4000	2.5 to 5.5	-40 to +125	SPI, 8 Gain Steps, Software Shutdown	8-Pin PDIP, 8-Pin SSOIC, 8-Pin MSOP
MCP6S92	2	1 to 18	1.0 mA	4000	2.5 to 5.5	-40 to +125	SPI, 8 Gain Steps, Software Shutdown	8-Pin PDIP, 8-Pin SSOIC, 8-Pin MSOP
MCP6S93	2	1 to 18	1.0 mA	4000	2.5 to 5.5	-40 to +125	SPI, 8 Gain Steps, Software Shutdown	10-Pin MSOP

LINEAR – Integrated Devices

Part #	# of Op Amps per Package	# of Comparators per Package	Iq Typical (μ A)	VREF (V)	Operating Voltage (V)	Temp. Range ($^{\circ}$ C)	Features	Packages
TC1026C	1	1	12	1.2	1.8 to 5.5	-40 to +85	On-board VREF	8-Pin PDIP, 8-Pin MSOP, 8-Pin SOIC
TC1043C	2	2	16	1.2	1.8 to 5.5	-40 to +85	On-board VREF, Shutdown pin	16-Pin QSOP

LINEAR – Comparators

Part #	# per Package	VREF (V)	Typical Propagation Delay (μ s)	Iq Typical (μ A)	Vos Max (mV)	Operating Voltage (V)	Temp. Range ($^{\circ}$ C)	Features	Packages
TC1027	4	1.2	4	18	5	1.8 to 5.5	-40 to +85	On-board VREF	16-Pin PDIP, 16-Pin QSOP, 16-Pin SOIC
TC1037	1	—	4	4	5	1.8 to 5.5	-40 to +85		5-Pin SOT-23A
TC1038	1	—	4	4	5	1.8 to 5.5	-40 to +85	Shutdown pin	6-Pin SOT-23A
TC1039	1	1.2	4	6	5	1.8 to 5.5	-40 to +85	On-board VREF	6-Pin SOT-23A
TC1041	2	1.2	4	10	5	1.8 to 5.5	-40 to +85	On-board VREF, Programmable hysteresis	8-Pin MSOP, 8-Pin SOIC
MCP6541	1	—	4	1	5	1.6 to 5.5	-40 to +85	Push-Pull, Rail-to-Rail Input/Output	5-Pin SOT-23, 8-Pin PDIP, 8-Pin SOIC, 8-Pin MSOP
MCP6542	2	—	4	1	5	1.6 to 5.5	-40 to +85	Push-Pull, Rail-to-Rail Input/Output	8-Pin PDIP, 8-Pin SOIC, 8-Pin MSOP
MCP6543	1	—	4	1	5	1.6 to 5.5	-40 to +85	Push-Pull, Rail-to-Rail Input/Output, Chip Select	8-Pin PDIP, 8-Pin SOIC, 8-Pin MSOP
MCP6544	4	—	4	1	5	1.6 to 5.5	-40 to +85	Push-Pull, Rail-to-Rail Input/Output	14-Pin PDIP, 14-Pin SOIC, 14-Pin TSSOP
MCP6546	1	—	4	1	5	1.6 to 5.5	-40 to +85	Open-drain, 9V, Rail-to-Rail Input/Output	5-Pin SOT-23, 8-Pin PDIP, 8-Pin SOIC, 8-Pin MSOP
MCP6547	2	—	4	1	5	1.6 to 5.5	-40 to +85	Open-drain, 9V, Rail-to-Rail Input/Output	8-Pin PDIP, 8-Pin SOIC, 8-Pin MSOP
MCP6548	1	—	4	1	5	1.6 to 5.5	-40 to +85	Open-drain, 9V, Rail-to-Rail Input/Output, Chip Select	8-Pin PDIP, 8-Pin SOIC, 8-Pin MSOP
MCP6549	4	—	4	1	5	1.6 to 5.5	-40 to +85	Open-drain, 9V, Rail-to-Rail Input/Output	14-Pin PDIP, 14-Pin SOIC, 14-Pin TSSOP

NOTE: All Comparators have rail-to-rail inputs and outputs.

MIXED SIGNAL – Successive Approximation Register (SAR) A/D Converters

Part #	Resolution (bits)	Maximum Sampling Rate (ksamples/sec)	# of Input Channels	Input Type	Interface	Input Voltage Range (V)	Max. Supply Current (μ A)	Max. INL	Temp. Range ($^{\circ}$ C)	Packages
MCP3021	10	22	1	Single-ended	I ² C	2.7 to 5.5	250	+1 LSB	-40 to +125	5-Pin SOT-23A
MCP3001	10	200	1	Single-ended	SPI	2.7 to 5.5	500	\pm 1 LSB	-40 to +85	8-Pin PDIP, 8-Pin SOIC, 8-Pin TSSOP
MCP3002	10	200	2	Single-ended	SPI	2.7 to 5.5	650	\pm 1 LSB	-40 to +85	8-Pin PDIP, 8-Pin SOIC, 8-Pin TSSOP
MCP3004	10	200	4	Single-ended	SPI	2.7 to 5.5	550	\pm 1 LSB	-40 to +85	14-Pin PDIP, 14-Pin SOIC, 14-Pin TSSOP
MCP3008	10	200	8	Single-ended	SPI	2.7 to 5.5	550	\pm 1 LSB	-40 to +85	16-Pin PDIP, 16-Pin SOIC
MCP3221	12	22	1	Single-ended	I ² C	2.7 to 5.5	250	\pm 2 LSB	-40 to +125	5-Pin SOT-23A
MCP3201	12	100	1	Single-ended	SPI	2.7 to 5.5	400	\pm 1 LSB	-40 to +85	8-Pin PDIP, 8-Pin SOIC, 8-Pin TSSOP
MCP3202	12	100	2	Single-ended	SPI	2.7 to 5.5	550	\pm 1 LSB	-40 to +85	8-Pin PDIP, 8-Pin SOIC, 8-Pin TSSOP
MCP3204	12	100	4	Single-ended	SPI	2.7 to 5.5	400	\pm 1 LSB	-40 to +85	14-Pin PDIP, 14-Pin SOIC, 14-Pin TSSOP
MCP3208	12	100	8	Single-ended	SPI	2.7 to 5.5	400	\pm 1 LSB	-40 to +85	16-Pin PDIP, 16-Pin SOIC
MCP3301	13	100	1	Differential	SPI	2.7 to 5.5	450	\pm 1 LSB	-40 to +85	8-Pin PDIP, 8-Pin SOIC, 8-Pin MSOP
MCP3302	13	100	2	Differential	SPI	2.7 to 5.5	450	\pm 1 LSB	-40 to +85	14-Pin PDIP, 14-Pin SOIC, 14-Pin TSSOP
MCP3304	13	100	4	Differential	SPI	2.7 to 5.5	450	\pm 1 LSB	-40 to +85	16-Pin PDIP, 16-Pin SOIC

MIXED SIGNAL – Sigma-Delta A/D Converters

Part #	Resolution (bits)	Maximum Sampling Rate (samples/sec)	# of Input Channels	Interface	Supply Voltage Range (V)	Typical Supply Current (μ A)	Typical INL (%FSR)	Temp. Range ($^{\circ}$ C)	Features	Packages
TC3400 ⁽¹⁾	10 to 16	>400	1 Diff	2-Wire	1.8 to 5.5	260	0.0038	0 to +85		8-Pin PDIP, 8-Pin SOIC
TC3401 ⁽¹⁾	10 to 16	>400	2 Diff	2-Wire	1.8 to 5.5	300	0.0038	0 to +85	Enable mode, Reset monitor, Power-fail monitor	16-Pin PDIP, 16-Pin QSOP
TC3402 ⁽¹⁾	10 to 16	>400	4 Diff	2-Wire	1.8 to 5.5	250	0.0038	0 to +85		16-Pin PDIP, 16-Pin QSOP
TC3405 ⁽¹⁾	10 to 16	>400	3 Single-ended, 1 Diff	2-Wire	1.8 to 5.5	250	0.0038	0 to +85	Enable mode, Reset monitor	16-Pin PDIP, 16-Pin QSOP

NOTE 1: All TC340X are not recommended for new designs.

MIXED SIGNAL – Dual Slope A/D Converters

Part #	Supply Voltage (V)	Input Voltage Range (V)	Resolution	Sampling Rate (Conv/s)	Input Channels	Data Interface	Temp. Range ($^{\circ}$ C)	Features	Packages
TC500	\pm 4.5 to \pm 7.5	VSS + 1.5V to VDD – 1.5V	Up to 16 bits	4 to 10	1	3-Wire	0 to +70	Differential input range, Programmable resolution/conversion time	16-Pin PDIP, 16-Pin SOIC, 16-Pin CerDIP
TC500A	\pm 4.5 to \pm 7.5	VSS + 1.5V to VDD – 1.5V	Up to 17 bits	4 to 10	1	3-Wire	0 to +70	Differential input range, Programmable resolution/conversion time	16-Pin PDIP, 16-Pin SOIC, 16-Pin CerDIP
TC510	+4.5 to +5.5	VSS + 1.5V to VDD – 1.5V	Up to 17 bits	4 to 10	1	3-Wire	0 to +70	Differential input range, Programmable resolution/conversion time, Charge pump (-V) output pin	24-Pin PDIP, 24-Pin SOIC

MIXED SIGNAL – Dual Slope A/D Converters

Part #	Supply Voltage (V)	Input Voltage Range (V)	Resolution	Sampling Rate (Conv/s)	Input Channels	Data Interface	Temp. Range (°C)	Features	Packages
TC514	+4.5 to +5.5	V _{SS} + 1.5V to V _{DD} – 1.5V	Up to 17 bits	4 to 10	4	3-Wire	0 to +70	Differential input range, Programmable resolution/conversion time, Charge pump (-V) output pin	28-Pin PDIP, 28-Pin SOIC
TC520A	+4.5 to +5.5	—	—	—	—	Serial port	0 to +70	Optional serial interface adapter for TC500/500A/510/514	14-Pin PDIP, 16-Pin SOIC
TC530	+4.5 to +5.5	V _{SS} + 1.5V to V _{DD} – 1.5V	Up to 17 bits	3 to 10	1	Serial port	0 to +70	Differential input range, Programmable resolution/conversion time, Charge pump (-V) output pin	28-Pin PDIP, 28-Pin SOIC
TC534	+4.5 to +5.5	V _{SS} + 1.5V to V _{DD} – 1.5V	Up to 17 bits	3 to 10	4	Serial port	0 to +70	Differential input range, Programmable resolution/conversion time, Charge pump (-V) output pin	40-Pin PDIP, 44-Pin MQFP
TC7109	±4.5 to ±5.5	V _{SS} + 1.5V to V _{DD} – 1.0V	12 bits plus sign bit	2 to 10	1	Parallel or Serial port	-25 to +85	Differential input range	40-Pin PDIP, 40-Pin CerDip, 44-Pin PLCC, 44-Pin MQFP
TC7109A	±4.5 to ±5.5	V _{SS} + 1.5V to V _{DD} – 1.0V	12 bits plus sign bit	2 to 10	1	Parallel or Serial port	-25 to +85	Differential input range	40-Pin PDIP, 40-Pin CerDip, 44-Pin PLCC, 44-Pin MQFP

MIXED SIGNAL – Binary and BCD A/D Converters

Part #	Description	Supply Voltage (V)	Input Voltage Range (V)	Resolution (Digits)	Resolution (Counts)	Max Power (mW)	Data Interface	Temp. Range (°C)	Features	Packages
TC835	BCD A/D	±5	V _{SS} + 1.0V to V _{DD} – 0.5V	4½	±20,000	30	MUXed BCD	0 to +70	Upgrade to TC7135	64-Pin MQFP, 44-Pin MQFP, 28-Pin PDIP
TC850	Binary A/D	±5	V _{SS} + 1.5V to V _{DD} – 1.5V	15-bit	±32,768	35	8-bit parallel	-25 to +70	Highest conversion speed (40 conv/sec)	44-Pin PLCC, 40-Pin PDIP, 40-Pin CerDIP
TC7135	BCD A/D	±5	V _{SS} + 1.0V to V _{DD} – 1.0V	4½	±20,000	30	MUXed BCD	0 to +70	For DMM, DPM, Data loggers	28-Pin PLCC, 28-Pin PDIP, 64-Pin MQFP
TC14433	BCD A/D	±4.5 to ±8	±199.9 mV to 1.999V	3½	±2,000	20	MUXed BCD	-40 to +85	For DMM, DPM, Data loggers	24-Pin SOIC, 24-Pin PDIP, 28-Pin PLCC, 24-Pin CerDIP
TC14433A	BCD A/D	±4.5 to ±8	±199.9 mV to 1.999V	3½	±2,000	20	MUXed BCD	-40 to +85	For DMM, DPM, Data loggers	24-Pin PDIP, 28-Pin PLCC, 24-Pin CerDIP

MIXED SIGNAL – Display A/D Converters

Part #	Display Type	Supply Voltage (V)	Resolution (Digits)	Resolution (Counts)	Power (mW)	Temp. Range (°C)	Features	Packages
TC820	LCD	9	3¾	±4,000	10	0 to +70	DMM plus frequency counter and logic probe	40-Pin PDIP, 44-Pin PLCC, 44-Pin MQFP
TC7106	LCD	9	3½	±2,000	10	-25 to +85	For DMM, DPM, Data logger applications	40-Pin PDIP, 44-Pin PLCC, 44-Pin MQFP, 40-Pin CerDIP
TC7106A	LCD	9	3½	±2,000	10	-25 to +85	For DMM, DPM, Data logger applications	40-Pin PDIP, 44-Pin PLCC, 44-Pin MQFP, 40-Pin CerDIP
TC7107	LED	±5	3½	±2,000	10	-25 to +85	For DMM, DPM, Data logger applications	40-Pin PDIP, 44-Pin PLCC, 44-Pin MQFP, 40-Pin CerDIP
TC7107A	LED	±5	3½	±2,000	10	-25 to +85	For DMM, DPM, Data logger applications	40-Pin PDIP, 44-Pin PLCC, 44-Pin MQFP, 40-Pin CerDIP
TC7116	LCD	9	3½	±2,000	10	-25 to +85	Hold function	40-Pin PDIP, 44-Pin PLCC, 44-Pin MQFP, 40-Pin CerDIP
TC7116A	LCD	9	3½	±2,000	10	-25 to +85	Hold function	40-Pin PDIP, 44-Pin PLCC, 44-Pin MQFP, 40-Pin CerDIP

MIXED SIGNAL – Display A/D Converters

Part #	Display Type	Supply Voltage (V)	Resolution (Digits)	Resolution (Counts)	Power (mW)	Temp. Range (°C)	Features	Packages
TC7117	LED	±5	3½	±2,000	10	-25 to +85	Hold function	40-Pin PDIP, 44-Pin PLCC, 44-Pin MQFP, 40-Pin CerDIP
TC7117A	LED	±5	3½	±2,000	10	-25 to +85	Hold function	40-Pin PDIP, 44-Pin PLCC, 44-Pin MQFP, 40-Pin CerDIP
TC7126	LCD	9	3½	±2,000	0.5	-25 to +85	Low-power TC7106	40-Pin PDIP, 44-Pin PLCC, 44-Pin MQFP, 40-Pin CerDIP
TC7126A	LCD	9	3½	±2,000	0.5	-25 to +85	Low-power TC7106	40-Pin PDIP, 44-Pin PLCC, 44-Pin MQFP, 40-Pin CerDIP
TC7129	LCD	9	4½	±20,000	4.5	0 to +70	Lowest noise ±3 mV sensitivity	40-Pin PDIP, 44-Pin PLCC, 44-Pin MQFP

MIXED SIGNAL – Digital Potentiometers

Part #	Number of Taps	Memory	Number per Package	Interface	Resistance (ohms)	INL (max)	DNL (max)	Temp. Range (°C)	Comments	Packages
MCP4021	64	Non-volatile	1	Up/Down	2, 5, 10, 50	0.5	0.5	-40 to +125	Potentiometer mode, Shutdown, WiperLock™ Technology	6-Pin SOT-23, 8-Pin SOIC, 8-Pin MSOP, 8-Pin 3x2 DFN
MCP4022	64	Non-volatile	1	Up/Down	2, 5, 10, 50	0.5	0.5	-40 to +125	Rheostat mode, Shutdown, WiperLock™ Technology	6-Pin SOT-23
MCP4023	64	Non-volatile	1	Up/Down	2, 5, 10, 50	0.5	0.5	-40 to +125	Potentiometer to Vss, WiperLock™ Technology	6-Pin SOT-23
MCP4024	64	Non-volatile	1	Up/Down	2, 5, 10, 50	0.5	0.5	-40 to +125	Rheostat to Vss, Shutdown, WiperLock™ Technology	5-Pin SOT-23
MCP41010	256	Volatile	1	SPI™	10	1	1	-40 to +85	Potentiometer mode, Shutdown	8-Pin PDIP, 8-Pin SOIC
MCP41050	256	Volatile	1	SPI™	50	1	1	-40 to +85	Potentiometer mode, Shutdown	8-Pin PDIP, 8-Pin SOIC
MCP41100	256	Volatile	1	SPI™	100	1	1	-40 to +85	Potentiometer mode, Shutdown	8-Pin PDIP, 8-Pin SOIC
MCP42010	256	Volatile	2	SPI™	10	1	1	-40 to +85	Potentiometer mode, Shutdown	14-Pin PDIP, 14-Pin SOIC, 14-Pin TSSOP
MCP42050	256	Volatile	2	SPI™	50	1	1	-40 to +85	Potentiometer mode, Shutdown	14-Pin PDIP, 14-Pin SOIC, 14-Pin TSSOP
MCP42100	256	Volatile	2	SPI™	100	1	1	-40 to +85	Potentiometer mode, Shutdown	14-Pin PDIP, 14-Pin SOIC, 14-Pin TSSOP

MIXED SIGNAL – Frequency-to-Voltage/Voltage-to-Frequency Converters

Part #	Frequency Range (kHz)	Full Scale (ppm FS/°C)	Non-linearity (%FS)	Temp. Range (°C)	Packages
TC9400	100	±40	±0.05	-40 to +85	14-Pin PDIP, 14-Pin SOIC
TC9401	100	±40	±0.02	-40 to +85	14-Pin PDIP, 14-Pin SOIC
TC9402	100	±100	±0.25	-40 to +85	14-Pin PDIP, 14-Pin SOIC

MIXED SIGNAL – System D/A Converters

Part #	Resolution (Bits)	DACs per Package	Interface	VREF	Output Settling Time (μs)	DNL (LSB)	Typical Standby Current (μA)	Typical Operating Current (μA)	Temp. Range (°C)	Packages
TC1320	8	1	SMBus	Ext	10	±0.8	0.1	350	-40 to +85	8-Pin MSOP, 8-Pin SOIC
TC1321	10	1	SMBus	Ext	10	±2	0.1	350	-40 to +85	8-Pin MSOP, 8-Pin SOIC
MCP4921	12	1	SPI	Ext	4.5	0.75	1	175	-40 to +125	8-Pin PDIP, 8-Pin SOIC, 8-Pin MSOP
MCP4922	12	2	SPI	Ext	4.5	0.75	1	350	-40 to +125	14-Pin PDIP, 14-Pin SOIC, 14-Pin TSSOP

NOTE: The analog output is voltage.

INTERFACE – Controller Area Network (CAN) Products

Part #	Operating Voltage (V)	Temperature Range (°C)	Tx Buffers	Rx Buffers	Filters	Masks	Interrupt Output	Unique Features	Packages
MCP2510 ⁽¹⁾	2.7 to 5.5	-40 to +125	3	2	6	2	Yes	CAN 2.0B Active controller with SPI interface to MCU, 3 transmit buffers, 2 receive buffers, HW and SW message triggers	18-Pin PDIP, 18-Pin SOIC, 20-Pin TSSOP
MCP2515	2.7 to 5.5	-40 to +125	3	2	6	2	Yes	MCP2510 pin compatible upgrade with enhanced features including higher throughput and data byte filtering	18-Pin PDIP, 18-Pin SOIC, 20-Pin TSSOP
MCP25020	2.7 to 5.5	-40 to +125	3	2	2	1	N/A	CAN 2.0B Active I/O Expander, Configurable I/O, 2 PWM outputs	14-Pin PDIP, 14-Pin SOIC
MCP25025	2.7 to 5.5	-40 to +85	3	2	2	1	N/A	CAN 2.0B Active I/O Expander, Configurable I/O, 2 PWM outputs, One-wire CAN option	14-Pin PDIP, 14-Pin SOIC
MCP25050	2.7 to 5.5	-40 to +125	3	2	2	1	N/A	Mixed-Signal CAN 2.0B Active I/O Expander, Configurable I/O, 4 10-bit ADCs, 2 PWM outputs	14-Pin PDIP, 14-Pin SOIC
MCP25055	2.7 to 5.5	-40 to +85	3	2	2	1	N/A	Mixed-Signal CAN 2.0B Active I/O Expander, Configurable I/O, 4 10-bit ADCs, 2 PWM outputs, One-wire CAN option	14-Pin PDIP, 14-Pin SOIC
MCP2551	4.5 to 5.5	-40 to +125	n/a	n/a	n/a	n/a	N/A	High-speed CAN Transceiver (1 Mbps max. CAN bus speed), ISO11898 compatible, Industry standard pinout	8-Pin PDIP, 8-Pin SOIC

NOTE 1: Not recommended for new designs.

INTERFACE – Infrared Products

Part #	Operating Voltage (V)	Operating Temperature Range (°C)	Max. Baud Rate (Kbaud)	Unique Features	Packages
MCP2120	2.5 to 5.5	-40 to +85	325	UART to IR encoder/decoder with both hardware and software baud rate selection	14-Pin PDIP, 14-Pin SOIC
MCP2122	1.8 to 5.5	-40 to +85	16x less than clock input	UART to IR encoder/decoder	8-Pin PDIP, 8-Pin SOIC
MCP2140	2.7 to 5.5	-40 to +85	9.6	IrDA® Standard protocol handler plus bit encoder/decoder, Fixed baud rate, Low-cost	18-Pin PDIP, 18-Pin SOIC, 20-Pin SSOP

NOTE: IrDA® is a registered trademark of Infrared Data Association.

INTERFACE – Infrared Products

Part #	Operating Voltage (V)	Operating Temperature Range (°C)	Max. Baud Rate (Kbaud)	Unique Features	Packages
MCP2150	3.0 to 5.5	-40 to +85	115.2	IrDA® Standard protocol handler plus bit encoder/decoder on one chip for DTE applications, Programmable ID	18-Pin PDIP, 18-Pin SOIC, 20-Pin SSOP
MCP2155	3.0 to 5.5	-40 to +85	115.2	IrDA® Standard protocol handler plus bit encoder/decoder on one chip for DCE applications, Programmable ID	18-Pin PDIP, 18-Pin SOIC, 20-Pin SSOP

NOTE: IrDA® is a registered trademark of Infrared Data Association.

INTERFACE – LIN Transceiver Products

Part #	Description	Vreg Output Voltage (V)	Operating Temperature Range (°C)	Vreg Output Current (mA)	Vcc Range (V)	Max Baud Rate	LIN Specification Supported	Packages
MCP201	LIN Transceiver with integrated VREG	4.75 to 5.25	-40 to +125	50	7.4 to 18 ⁽¹⁾	20 Kbaud	Revision 1.2	8-pin PDIP, 8-pin SOIC, 8-Pin DFN

NOTE 1: Can withstand 40V load dump.

INTERFACE – Serial Peripherals

Part #	Description	Operating Voltage (V)	Operating Temperature Range (°C)	Bus Type	Max. Bus Frequency (kHz)	Features	Packages
MCP23008	8-bit I/O Port Expander	1.8 to 5.5	-40 to +85	I ² C™	3400	3 HW address pins, HW interrupt, 25 mA source/sink capability per I/O	18-Pin PDIP, 18-Pin SOIC, 20-Pin SSOP
MCP23S08	8-bit I/O Port Expander	1.8 to 5.5	-40 to +85	SPI™	10000	2 HW address pins, HW interrupt, 25 mA source/sink capability per I/O	18-Pin PDIP, 18-Pin SOIC, 20-Pin SSOP
MCP23016	16-bit I/O Port Expander	2.0 to 5.5	-40 to +85	I ² C™	400	3 H/W address inputs, HW interrupt, 25 mA source/sink capability per I/O	28-Pin PDIP, 28-Pin SOIC, 28-Pin SSOP, 28-Pin 6x6 QFN

SERIAL ELECTRICALLY ERASABLE PROMS (EEPROM)

Product	E/W Cycles	Density (Organization)	Write Speed	Max. Clock Freq.	Operating Voltage (V)	Temps	Max. Standby Current	Unique Features	Packages ⁽¹⁾
Microwire Compatible Serial EEPROM Family – Automatic ERAL before WRAL, self-timed erase and write cycle, power on/off data protection circuitry, sequential read function and industry standard 3-wire serial I/O									
93C46A	1M	1 Kbits (x8)	2 ms	2 MHz	4.5 to 5.5	C, I, E	5 μ A	93Cx6A and 93Cx6B devices have no ORG pin. 93Cx6A parts have x8 organization; 93Cx6B parts are x16. Devices in this family include POR (VDD detect) feature. Use 93C76C or 93C86C devices for P, SN, ST or MS packages. Use 93C76C or 93C86C devices for P, SN, ST or MS packages. Use 93C76C or 93C86C devices for P, SN, ST or MS packages. Use 93C76C or 93C86C devices for P, SN, ST or MS packages.	P, SN, ST, MS, OT, X/SN, MC
93C46B	1M	1 Kbits (x16)	2 ms	2 MHz	4.5 to 5.5	C, I, E	5 μ A		P, SN, ST, MS, OT, X/SN, MC
93C56A	1M	2 Kbits (x8)	2 ms	2 MHz	4.5 to 5.5	I, E	5 μ A		P, SN, ST, MS, OT, MC
93C56B	1M	2 Kbits (x16)	2 ms	2 MHz	4.5 to 5.5	I, E	5 μ A		P, SN, ST, MS, OT, MC
93C66A	1M	4 Kbits (x8)	2 ms	2 MHz	4.5 to 5.5	I, E	5 μ A		P, SN, ST, MS, OT, MC
93C66B	1M	4 Kbits (x16)	2 ms	2 MHz	4.5 to 5.5	I, E	5 μ A		P, SN, ST, MS, OT, MC
93C76A	1M	8 Kbits (x8)	2 ms	3 MHz	4.5 to 5.5	I, E	5 μ A		OT
93C76B	1M	8 Kbits (x16)	2 ms	3 MHz	4.5 to 5.5	I, E	5 μ A		OT
93C86A	1M	16 Kbits (x8)	2 ms	3 MHz	4.5 to 5.5	I, E	5 μ A		OT
93C86B	1M	16 Kbits (x16)	2 ms	3 MHz	4.5 to 5.5	I, E	5 μ A		OT
93LC46A	1M	1 Kbits (x8)	6 ms	2 MHz	2.5 to 5.5	C, I, E	5 μ A	93LCx6A and 93LCx6B devices have no ORG pin. 93LCx6A parts have x8 organization; 93Cx6B parts are x16. Use 93LC76C or 93LC86C devices for P, SN, ST or MS packages. Use 93LC76C or 93LC86C devices for P, SN, ST or MS packages. Use 93LC76C or 93LC86C devices for P, SN, ST or MS packages. Use 93LC76C or 93LC86C devices for P, SN, ST or MS packages.	P, SN, ST, MS, OT, X/SN, MC
93LC46B	1M	1 Kbits (x16)	6 ms	2 MHz	2.5 to 5.5	C, I, E	5 μ A		P, SN, ST, MS, OT, X/SN, MC
93LC56A	1M	2 Kbits (x8)	6 ms	2 MHz	2.5 to 5.5	C, I, E	5 μ A		P, SN, ST, MS, OT, X/SN, MC
93LC56B	1M	2 Kbits (x16)	6 ms	2 MHz	2.5 to 5.5	C, I, E	5 μ A		P, SN, ST, MS, OT, X/SN, MC
93LC66A	1M	4 Kbits (x8)	6 ms	2 MHz	2.5 to 5.5	C, I, E	5 μ A		P, SN, ST, MS, OT, X/SN, MC
93LC66B	1M	4 Kbits (x16)	6 ms	2 MHz	2.5 to 5.5	C, I, E	5 μ A		P, SN, ST, MS, OT, X/SN, MC
93LC76A	1M	8 Kbits (x8)	6 ms	3 MHz	2.5 to 5.5	I, E	5 μ A		OT
93LC76B	1M	8 Kbits (x16)	6 ms	3 MHz	2.5 to 5.5	I, E	5 μ A		OT
93LC86A	1M	16 Kbits (x8)	6 ms	3 MHz	2.5 to 5.5	I, E	5 μ A		OT
93LC86B	1M	16 Kbits (x16)	6 ms	3 MHz	2.5 to 5.5	I, E	5 μ A		OT
93AA46A	1M	1 Kbits (x8)	6 ms	2 MHz	1.8 to 5.5	I	5 μ A	93AAx6A and 93AAx6B devices have no ORG pin. 93AAx6A parts have x8 organization; 93Cx6B parts are x16. Use 93AA76C or 93AA86C devices for P, SN, ST or MS packages. Use 93AA76C or 93AA86C devices for P, SN, ST or MS packages. Use 93AA76C or 93AA86C devices for P, SN, ST or MS packages. Use 93AA76C or 93AA86C devices for P, SN, ST or MS packages.	P, SN, ST, MS, OT, MC
93AA46B	1M	1 Kbits (x16)	6 ms	2 MHz	1.8 to 5.5	I	5 μ A		P, SN, ST, MS, OT, MC
93AA56A	1M	2 Kbits (x8)	6 ms	2 MHz	1.8 to 5.5	I	5 μ A		P, SN, ST, MS, OT, MC
93AA56B	1M	2 Kbits (x16)	6 ms	2 MHz	1.8 to 5.5	I	5 μ A		P, SN, ST, MS, OT, MC
93AA66A	1M	4 Kbits (x8)	6 ms	2 MHz	1.8 to 5.5	I	5 μ A		P, SN, ST, MS, OT, MC
93AA66B	1M	4 Kbits (x16)	6 ms	2 MHz	1.8 to 5.5	I	5 μ A		P, SN, ST, MS, OT, MC
93AA76A	1M	8 Kbits (x8)	6 ms	3 MHz	1.8 to 5.5	I	5 μ A		OT
93AA76B	1M	8 Kbits (x16)	6 ms	3 MHz	1.8 to 5.5	I	5 μ A		OT
93AA86A	1M	16 Kbits (x8)	6 ms	3 MHz	1.8 to 5.5	I	5 μ A		OT
93AA86B	1M	16 Kbits (x16)	6 ms	3 MHz	1.8 to 5.5	I	5 μ A		OT
93C46C	1M	1 Kbits (x8 or x16)	2 ms	3 MHz	4.5 to 5.5	I, E	5 μ A	93Cx6C devices can be used in either x8 or x16 organization via the ORG pin. Devices in this family include POR (VDD detect) feature.	P, SN, ST, MS, MC
93C56C	1M	2 Kbits (x8 or x16)	2 ms	3 MHz	4.5 to 5.5	I, E	5 μ A		P, SN, ST, MS, MC
93C66C	1M	4 Kbits (x8 or x16)	2 ms	3 MHz	4.5 to 5.5	I, E	5 μ A		P, SN, ST, MS, MC
93C76C	1M	8 Kbits (x8 or x16)	2 ms	3 MHz	4.5 to 5.5	I, E	5 μ A		P, SN, ST, MS, MC
93C86C	1M	16 Kbits (x8 or x16)	2 ms	3 MHz	4.5 to 5.5	I, E	5 μ A		P, SN, ST, MS, MC
93LC46C	1M	1 Kbits (x8 or x16)	6 ms	3 MHz	2.5 to 5.5	I, E	5 μ A	93LCx6C devices can be used in either x8 or x16 organization via the ORG pin.	P, SN, ST, MS, X/SN, MC
93LC56C	1M	2 Kbits (x8 or x16)	6 ms	3 MHz	2.5 to 5.5	I, E	5 μ A		P, SN, ST, MS, X/SN, MC
93LC66C	1M	4 Kbits (x8 or x16)	6 ms	3 MHz	2.5 to 5.5	I, E	5 μ A		P, SN, ST, MS, X/SN, MC
93LC76C	1M	8 Kbits (x8 or x16)	6 ms	3 MHz	2.5 to 5.5	I, E	5 μ A		P, SN, ST, MS, MC
93LC86C	1M	16 Kbits (x8 or x16)	6 ms	3 MHz	2.5 to 5.5	I, E	5 μ A		P, SN, ST, MS, MC
93AA46C	1M	1 Kbits (x8 or x16)	6 ms	3 MHz	1.8 to 5.5	I	5 μ A	93AAx6C devices can be used in either x8 or x16 organization via the ORG pin.	P, SN, ST, MS, X/SN, MC
93AA56C	1M	2 Kbits (x8 or x16)	6 ms	3 MHz	1.8 to 5.5	I	5 μ A		P, SN, ST, MS, X/SN, MC
93AA66C	1M	4 Kbits (x8 or x16)	6 ms	3 MHz	1.8 to 5.5	I	5 μ A		P, SN, ST, MS, X/SN, MC
93AA76C	1M	8 Kbits (x8 or x16)	6 ms	3 MHz	1.8 to 5.5	I	5 μ A		P, SN, ST, MS, MC
93AA86C	1M	16 Kbits (x8 or x16)	6 ms	3 MHz	1.8 to 5.5	I	5 μ A		P, SN, ST, MS, MC

NOTE 1. X/SN package code denotes rotated pinouts.

Product	E/W Cycles	Density (Organization)	Write Speed	Max. Clock Frequency	Operating Voltage (V)	Temps	Unique Features	Packages
2-Wire I²C™ Compatible Serial EEPROM Family – Self-timed write cycle and Page Write mode								
24C00	1M	128 bits (x8)	4 ms	400 kHz	4.5 to 5.5	C, I, E	100 kHz operation for voltages from 1.8V to 4.5V.	P, SN, ST, OT, MC
24LC00	1M	128 bits (x8)	4 ms	400 kHz	2.5 to 6.0	C, I		P, SN, ST, OT, MC
24AA00	1M	128 bits (x8)	4 ms	400 kHz	1.8 to 6.0	C, I		P, SN, ST, OT, MC
24C01C	1M	1 Kbits (x8)	1 ms	400 kHz	4.5 to 5.5	C, I, E	The 24C01C and 24C02C are for applications which require fast byte write and/or extended temperature. Three address pins.	P, SN, ST, MS, MC
24C02C	1M	2 Kbits (x8)	1 ms	400 kHz	4.5 to 5.5	C, I, E		P, SN, ST, MS, MC
24LC014	1M	1 Kbit (x8)	10 ms	400 MHz	2.5 to 5.5	I	Three address pins.	P, SN, ST, MS, MC
24AA014	1M	1 Kbit (x8)	10 ms	400 MHz	1.8 to 5.5	I		P, SN, ST, MS, MC
24LC01B	1M	1 Kbits (x8)	5 ms	400 kHz	2.5 to 5.5	I, E	Hardware write protect. Schmitt trigger inputs. 2.5V operation @ extended temperatures. 100 kHz operation @ extended temperatures. B version on 2-wire devices designates that address pins A0, A1, A2 are no-connect.	P, SN, ST, MS, OT, MC
24LC02B	1M	2 Kbits (x8)	5 ms	400 kHz	2.5 to 5.5	I, E		P, SN, ST, MS, OT, MC
24LC04B	1M	4 Kbits (x8)	5 ms	400 kHz	2.5 to 5.5	I, E		P, SN, ST, MS, OT, MC
24LC08B	1M	8 Kbits (x8)	5 ms	400 kHz	2.5 to 5.5	I, E		P, SN, ST, MS, OT, MC
24LC16B	1M	16 Kbits (x8)	5 ms	400 kHz	2.5 to 5.5	I, E		P, SN, ST, MS, OT, MC
24AA01	1M	1 Kbits (x8)	5 ms	400 kHz	1.8 to 5.5	I		Hardware write protect. Schmitt trigger inputs. 100 kHz operation for voltages from 1.8V to 2.5V. For all devices in this section (24AA01 through 24AA16), pins A0, A1, A2 are no-connect.
24AA02	1M	2 Kbits (x8)	5 ms	400 kHz	1.8 to 5.5	I	P, SN, ST, MS, OT, MC	
24AA04	1M	4 Kbits (x8)	5 ms	400 kHz	1.8 to 5.5	I	P, SN, ST, MS, OT, MC	
24AA08	1M	8 Kbits (x8)	5 ms	400 kHz	1.8 to 5.5	I	P, SN, ST, MS, OT, MC	
24AA16	1M	16 Kbits (x8)	5 ms	400 kHz	1.8 to 5.5	I	P, SN, ST, MS, OT, MC	
24LC32A	1M	32 Kbits (x8)	5 ms	400 kHz	2.5 to 5.5	I, E	100 kHz operation for voltages from 1.8V to 2.5V.	
24AA32A	1M	32 Kbits (x8)	5 ms	400 kHz	1.8 to 5.5	I		P, SN, SM, ST, MS, MC
24LC64	1M	64 Kbits (x8)	5 ms	400 kHz	2.5 to 5.5	I, E	32-byte page. 100 kHz operation for voltages from 1.8V to 2.5V.	P, SN, SM, ST, MS, MC
24AA64	1M	64 Kbits (x8)	5 ms	400 kHz	1.8 to 5.5	I		P, SN, SM, ST, MS, MC
24LC65	1 M/10 M	64 Kbits (x8)	5 ms	400 kHz	2.5 to 5.5	C, I	8-byte page, 64-byte input buffer, high-endurance block, write protectable in 4K blocks. Smart Serial™ EEPROM.	P, SM
24AA65	1 M/10 M	64 Kbits (x8)	5 ms	400 kHz	1.8 to 5.5	C		P, SM
24C65	1 M/10 M	64 Kbits (x8)	5 ms	400 kHz	4.5 to 5.5	C, I, E		P, SM
24LC128	1M	128 Kbits (x8)	5 ms	400 kHz	2.5 to 5.5	I, E	64-byte page. 100 kHz operation for voltages from 1.8V to 2.5V.	P, SN, SM, ST, MS, MF
24AA128	1M	128 Kbits (x8)	5 ms	400 kHz	1.8 to 5.5	I		P, SN, SM, ST, MS, MF
24FC128	1M	128 Kbits (x8)	5 ms	1 MHz	2.5 to 5.5	I	400 kHz operation for voltages below 4.5V (24FC128).	P, SN, SM, ST, MS, MF
24LC256	1M	256 Kbits (x8)	5 ms	400 kHz	2.5 to 5.5	I, E	64-byte page. 100 kHz operation for voltages from 1.8V to 2.5V.	P, SM, SN, ST, MS, MF
24AA256	1M	256 Kbits (x8)	5 ms	400 kHz	1.8 to 5.5	I		P, SM, SN, ST, MS, MF
24FC256	1M	256 Kbits (x8)	5 ms	1 MHz	2.5 to 5.5	I	400 kHz operation for voltages below 4.5V (24FC256).	P, SN, SM, ST, MS, MF
24LC512	1M	512 Kbits (x8)	5 ms	400 kHz	2.5 to 5.5	I, E	128-byte page, cascadeable up to 8 devices (4 Mbits). 100 kHz operation for voltages from 1.8 to 2.5V. 400 kHz operation for voltages below 4.5V. (24FC512).	P, MF, ST14, SM
24AA512	1M	512 Kbits (x8)	5 ms	400 kHz	1.8 to 5.5	I		P, MF, ST14, SM
24FC512	1M	512 Kbits (x8)	5 ms	1 MHz	2.5 to 5.5	I		P, MF, ST14, SM
24LC515	1M	512 Kbits (x8)	5 ms	400 kHz	2.5 to 5.5	I	Cascadeable up to 4 devices (2 Mbits). 100 kHz operation for voltages from 1.8V to 2.5V.	P, SM
24AA515	1M	512 Kbits (x8)	5 ms	400 kHz	1.8 to 5.5	I		P, SM
24FC515	1M	512 Kbits (x8)	5 ms	1 MHz	2.5 to 5.5	I		P, SM

Product	E/W Cycles	Density (Organization)	Write Speed	Max. Clock Frequency	Operating Voltage (V)	Temps	Unique Features	Packages
ISO Smart Card Family – Self-timed write cycle and Page Write mode. All devices meet ISO7816 pinout requirements.								
24LC01SC	1M	1 Kbits (x8)	5 ms	400 kHz	2.5 to 5.5	C, I		S, W, WF
24LC02SC	1M	2 Kbits (x8)	5 ms	400 kHz	2.5 to 5.5	C, I		S, W, WF
24LC04SC	1M	4 Kbits (x8)	5 ms	400 kHz	2.5 to 5.5	C, I		S, W, WF
24LC08SC	1M	8 Kbits (x8)	5 ms	400 kHz	2.5 to 5.5	C, I		S, W, WF
24LC16SC	1M	16 Kbits (x8)	5 ms	400 kHz	2.5 to 5.5	C, I		S, W, WF
24LC32ASC	1M	32 Kbits (x8)	5 ms	400 kHz	2.5 to 5.5	C, I		S, W, WF
24LC64SC	1M	64 Kbits (x8)	5 ms	400 kHz	2.5 to 5.5	C, I		S, W, WF
24LC128SC	1M	128 Kbits (x8)	5 ms	400 kHz	2.5 to 5.5	C, I		S, W, WF
24LC256SC	1M	256 Kbits (x8)	5 ms	400 kHz	2.5 to 5.5	C, I		S, W, WF
24LC512SC	1M	512 Kbits (x8)	5 ms	400 kHz	2.5 to 5.5	C, I		S, W, WF
24AA01SC	1M	1 Kbits (x8)	5 ms	400 kHz	1.8 to 5.5	C		S, W, WF
24AA02SC	1M	2 Kbits (x8)	5 ms	400 kHz	1.8 to 5.5	C		S, W, WF
24AA04SC	1M	4 Kbits (x8)	5 ms	400 kHz	1.8 to 5.5	C		S, W, WF
24AA08SC	1M	8 Kbits (x8)	5 ms	400 kHz	1.8 to 5.5	C		S, W, WF
24AA16SC	1M	16 Kbits (x8)	5 ms	400 kHz	1.8 to 5.5	C		S, W, WF
24AA32ASC	1M	32 Kbits (x8)	5 ms	400 kHz	1.8 to 5.5	C		S, W, WF
24AA64SC	1M	64 Kbits (x8)	5 ms	400 kHz	1.8 to 5.5	C		S, W, WF
24AA128SC	1M	128 Kbits (x8)	5 ms	400 kHz	1.8 to 5.5	C		S, W, WF
24AA256SC	1M	256 Kbits (x8)	5 ms	400 kHz	1.8 to 5.5	C		S, W, WF
24AA512SC	1M	512 Kbits (x8)	5 ms	400 kHz	1.8 to 5.5	C		S, W, WF

Product	E/W Cycles	Density (Organization)	Page Size	Write Speed	Max. Clock Frequency	Operating Voltage (V)	Temps	Unique Features	Packages ⁽¹⁾
SPI™ Compatible Serial EEPROM Family – Page Write mode, HOLD pin, software enabled block write protection and hardware write-protect pin. Supports SPI™ modes 0, 3.									
25C040	1M	4 Kbits (x8)	16B	5 ms	3 MHz	4.5 to 5.5	I, E		P, SN, X/ST
25LC040	1M	4 Kbits (x8)	16B	5 ms	2 MHz	2.5 to 5.5	I		P, SN, X/ST
25AA040	1M	4 Kbits (x8)	16B	5 ms	1 MHz	1.8 to 5.5	I		P, SN, X/ST
25LC080A	1M	8 Kbits (x8)	16B	5 ms	10 MHz	2.5 to 5.5	I, E		P, SN, ST, MS, MC
25AA080A	1M	8 Kbits (x8)	16B	5 ms	10 MHz	1.8 to 5.5	I		P, SN, ST, MS, MC
25LC080B	1M	8 Kbits (x8)	32B	5 ms	10 MHz	2.5 to 5.5	I, E		P, SN, ST, MS, MC
25AA080B	1M	8 Kbits (x8)	32B	5 ms	10 MHz	1.8 to 5.5	I		P, SN, ST, MS, MC

NOTE 1. X/ST package code denotes rotated pinout.

Product	E/W Cycles	Density (Organization)	Page Size	Write Speed	Max. Clock Frequency	Operating Voltage (V)	Temps	Unique Features	Packages ⁽¹⁾
SPI™ Compatible Serial EEPROM Family – Page Write mode, HOLD pin, software enabled block write protection and hardware write-protect pin. Supports SPI™ modes 0, 3. (continued)									
25LC160A	1M	16 Kbits (x8)	16B	5 ms	10 MHz	2.5 to 5.5	I, E		P, SN, ST, MS, MC
25AA160A	1M	16 Kbits (x8)	16B	5 ms	10 MHz	1.8 to 5.5	I		P, SN, ST, MS, MC
25LC160B	1M	16 Kbits (x8)	32B	5 ms	10 MHz	2.5 to 5.5	I, E		P, SN, ST, MS, MC
25AA160B	1M	16 Kbits (x8)	32B	5 ms	10 MHz	1.8 to 5.5	I		P, SN, ST, MS, MC
25C320	100K	32 Kbits (x8)	32B	5 ms	3 MHz	4.5 to 5.5	I, E		P, SN
25LC320	1M	32 Kbits (x8)	32B	5 ms	2 MHz	2.5 to 5.5	I, E		P, SN, X/ST
25AA320	1M	32 Kbits (x8)	32B	5 ms	1 MHz	1.8 to 5.5	I		P, SN, X/ST
25LC640	1M	64 Kbits (x8)	32B	5 ms	3 MHz	2.5 to 5.5	I, E		P, SN, X/ST
25AA640	1M	64 Kbits (x8)	32B	5 ms	1 MHz	1.8 to 5.5	I		P, SN, X/ST
25LC256 ⁽³⁾	1M	256 Kbits (x8)	64B	5 ms	10 MHz	2.5 to 5.5	I, E		P, SN, ST, MF
25AA256 ⁽³⁾	1M	256 Kbits (x8)	64B	5 ms	10 MHz	1.8 to 5.5	I		P, SN, ST, MF

NOTE 1. X/ST package code denotes rotated pinout.

Product	E/W Cycles	Density (Organization)	Write Speed	Max. Clock Frequency	Operating Voltage (V)	Temps	Unique Features	Packages
Identification Products (Application-Specific Products for Monitors, DRAM Modules, ACR Risers and Other Plug-And-Play Applications)								
24LC21	1M	1 Kbits (x8)	10 ms	400 kHz	2.5 to 5.5	C, I	Completely implements DDC1™/DDC2™ interface for VESA monitor identification. Improved noise filter. Write protection pin. Not recommended for new designs. Use 24LC21A or 24LCS21A.	P, SN
24LCS21	1M	1 Kbits (x8)	10 ms	400 kHz	2.5 to 5.5	C, I	Same as 24LC21 plus software enabled write-protect pin. Not recommended for new designs. Use 24LC21A or 24LCS21A.	P, SN
24LC21A	1M	1 Kbits (x8)	10 ms	400 kHz	2.5 to 5.5	C, I	Same as 24LC21 plus “return to DDC1” feature.	P, SN
24LCS21A	1M	1 Kbits (x8)	10 ms	400 kHz	2.5 to 5.5	C, I	Same as 24LC21A plus software enabled write-protect pin.	P, SN
24LCS22A	1M	2 Kbits (x8)	10 ms	400 kHz	2.5 to 5.5	I	Implements VESA E-EDID 1.3 for flat panels and projectors. Includes “return to DDC1” feature and software - enabled write protect pin.	P, SN
24LC024	1M	2 Kbits (x8)	10 ms	400 kHz	2.5 to 5.5	C, I	Addressable, hardware write protection for DRAM DIMM modules and other applications.	P, SN, ST, MS
24LC025	1M	2 Kbits (x8)	10 ms	400 kHz	2.5 to 5.5	C, I	Addressable. No write-protect.	P, SN, ST, MS
24AA52	1M	2 Kbits (x8)	10 ms	400 kHz	1.8 to 5.5	I	Addressable, hardware write protection and software write protection for lower half of the array. Designed for DRAM DIMM modules.	P, SN, ST, MS
24LCS52	1M	2 Kbits (x8)	10 ms	400 kHz	2.5 to 5.5	I		P, SN, ST, MS

DEVELOPMENT SYSTEMS

MPLAB® ICE 2000 and MPLAB® ICE 4000 Emulator Systems

HOW DO I ORDER MPLAB® ICE?

Ordering MPLAB® ICE is as easy as 1, 2, and 3!

- NOTE 1:** Choose your PICmicro® MCU.
2: Choose your PICmicro® MCU package.
3: Find the right line on the next few pages for MPLAB® ICE part numbers. You're ready to order.

A COMPLETE MPLAB® ICE SYSTEM

MPLAB® ICE is a modular emulator system with interchangeable components allowing the system to be easily configured to emulate different PICmicro® MCUs. Since this emulator supports package-specific emulation, customers need to know which device and package they intend to emulate. Then, the customer can use the *Cross Reference Parts List* on the following pages to identify the part numbers required to complete an MPLAB® ICE system. A complete system consists of:

- NOTE 1:** An emulator pod (including among other things the host-to-pod parallel cable and power supply)
2: A processor module
3: A device adapter
4: A transition socket

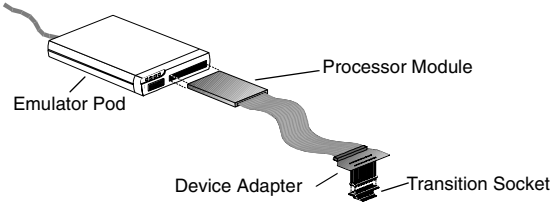

MPLAB® ICE 2000 Emulator

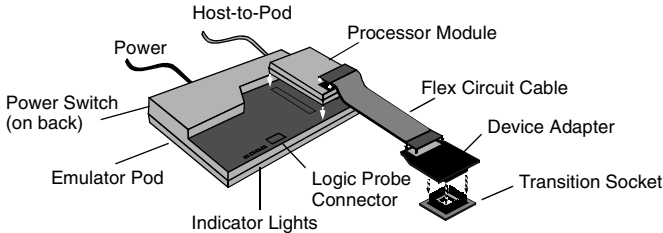

MPLAB® ICE 4000 Emulator

An MPLAB® ICE emulator system is ordered as separate components. Knowing the terms will make it easy to order and use the MPLAB® ICE emulator system. Read more about each component:

1. Emulator Pod

The MPLAB® ICE 2000 and MPLAB® ICE 4000 are full-featured emulator pods containing a main board with an additional board for expanded trace memory and complex control logic. The pods come with a standard parallel interface cable that connects the pods to the parallel port of the PC and a power supply. MPLAB® ICE 4000 also includes a USB interface cable that connects the pod to the USB port.

2. Processor Module

The processor module is a PICmicro®, device-specific module that is inserted into the emulator pod. The processor module contains the emulator chip, logic, and low-voltage circuitry. A flex cable extends from the processor module and is connected to the device adapter at the target application.

3. Device Adapter

The device adapter provides a common interface for the PICmicro® MCU being emulated. This adapter contains a special device that provides an oscillator clock allowing the user to accurately emulate the RC characteristics of the PICmicro® MCU. The device adapter provides emulation support for standard DIP and PLCC styles. For emulation support of other packages, a transition socket is needed along with the device adapter.

4. Transition Socket

The transition sockets are available in various styles to allow the common device adapter to be translated to support surface-mount packages, such as SOIC, SSOP, PQFP, TQFP and MLF.

PRO MATE® II and MPLAB® PM3 Programmers

The PRO MATE® II Programmer (DV007003) and the MPLAB® PM3 Programmer (DV007004) are Microchip's production rated programmers, which can be operated stand-alone or with a PC using MPLAB® IDE (included free). They come complete with accessories needed to connect to a host system, including a power supply and cables, giving the developer complete control over the programming session. Each programmer requires a socket module (to be purchased separately), which can be selected from the following chart by identifying the devices for programming and then picking the appropriate part number from their respective columns. In-Circuit Serial Programming™ (ICSP™) can be added to the PRO MATE® II Programmer by ordering Socket Module AC004004. MPLAB® PM3 has built-in ICSP™ programming capability.

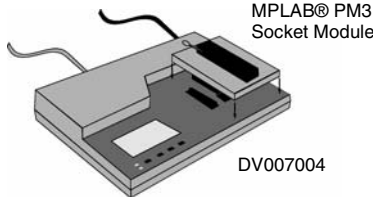
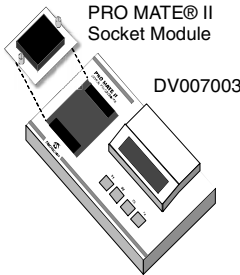

In-Circuit Debuggers: MPLAB® ICD 2

MPLAB® ICD 2 is a low cost, flash-based development tool that connects between the PC and the designer's target board allowing direct in-circuit debugging of the PICmicro® target microcontroller. Programs can be executed in real time or single step, watch variables established, break points set, memory read/writes accomplished and more. The MPLAB® ICD 2 can also be used as a development programmer for the microcontrollers.

MPLAB® ICE 2000 and MPLAB® ICE 4000 Emulator Systems, PRO MATE® II Programmer Socket Modules, MPLAB® In-Circuit Debugger, Software Tools, Programmers and Demonstration Boards

		MPLAB® ICE 2000 System (1)			MPLAB® ICE 4000 System (2)								
Part Number	Lead Count/ Pkg Type	Processor Module	Device Adapters	Transition Socket	Processor Module	Device Adapters	Transition Socket	PRO MATE® II Socket Module (3,4)	MPLAB® PM3 Socket Module (8)	PICSTART® Plus (5)	MPLAB® ICD 2 (6)	MPLAB® CXX Compiler	Demonstration Boards or Evaluation Kits
Analog Interface Development Tools													
MCP2120	14P												DM163008
MCP2150	18P												DM163008
MCP250XX	14P							AC254001	AC164301*				DV250501
MCP250XX	14SO							AC254001	AC164302*				
MCP2510	18P												DV251001
MCP2515	18P												DV251001
PICmicro® Microcontroller Development Tools													
PIC10F200	60T							AC164037	AC164321	✓	AC162059* +XLT06SOT		DV164101 +AC163020
PIC10F200	8P							AC164037	AC164301	✓	AC162059*		DV164101
PIC10F202	60T							AC164037	AC164321	✓	AC162059* +XLT06SOT		DV164101 +AC163020
PIC10F202	8P							AC164037	AC164301	✓	AC162059*		DV164101
PIC10F204	60T							AC164037	AC164321	✓	AC162059* +XLT06SOT		DV164101 +AC163020
PIC10F204	8P							AC164037	AC164301	✓	AC162059*		DV164101
PIC10F206	60T							AC164037	AC164321	✓	AC162059* +XLT06SOT		DV164101 +AC163020
PIC10F206	8P							AC164037	AC164301	✓	AC162059*		DV164101
PIC12C508	8P, 8JW	PCM16XA0	DVA12XP080					AC124001	AC164301	✓			DM163001, DVMCPA
PIC12C508	8SM	PCM16XA0	DVA12XP080	XLT08SO				AC124001	AC164312				
PIC12C508A	8P, 8JW	PCM16XA0	DVA12XP080					AC124001	AC164301	✓			DM163001, DVMCPA
PIC12C508A	8SM	PCM16XA0	DVA12XP080	XLT08SO				AC124001	AC164312				
PIC12C508A	8SN	PCM16XA0	DVA12XP080	XLT08SO				AC164026	AC164302				
PIC12C508A	8MF	PCM16XA0	DVA12XP080	XLT08DFN or XLT08DFN2				AC124001 +AC164032	AC164301 +AC164032	AC164032			
PIC12C509	8P, 8JW	PCM16XA0	DVA12XP080					AC124001	AC164301	✓			DM163001, DVMCPA
PIC12C509	8SM	PCM16XA0	DVA12XP080	XLT08SO				AC124001	AC164312				
PIC12C509A	8P, 8JW	PCM16XA0	DVA12XP080					AC124001	AC164301	✓			DM163001, DVMCPA
PIC12C509A	8SM	PCM16XA0	DVA12XP080	XLT08SO				AC124001	AC164312				
PIC12C509A	8SN	PCM16XA0	DVA12XP080	XLT08SO				AC164026	AC164302				
PIC12C509A	8MF	PCM16XA0	DVA12XP080	XLT08DFN or XLT08DFN2				AC124001 +AC164032	AC164301 +AC164032	AC164032			

NOTE: See complete list of notes on page 80.

MPLAB® ICE 2000 and MPLAB® ICE 4000 Emulator Systems, PRO MATE® II Programmer Socket Modules, MPLAB® In-Circuit Debugger, Software Tools, Programmers and Demonstration Boards

		MPLAB® ICE 2000 System (1)			MPLAB® ICE 4000 System (2)								
Part Number	Lead Count/ Pkg Type	Processor Module	Device Adapters	Transition Socket	Processor Module	Device Adapters	Transition Socket	PRO MATE® II Socket Module (3,4)	MPLAB® PM3 Socket Module (8)	PICSTART® Plus (5)	MPLAB® ICD 2 (6)	MPLAB® CXX Compiler	Demonstration Boards or Evaluation Kits
PICmicro® Microcontroller Development Tools (continued)													
PIC12C671	8P, 8JW	PCM12XA0	DVA12XP081					AC124001	AC164301	✓			
PIC12C671	8SM	PCM12XA0	DVA12XP081	XLT08SO				AC124001	AC164312				
PIC12C671	8MF	PCM12XA0	DVA12XP081	XLT08DFN or XLT08DFN2				AC124001 +AC164032	AC164301 +AC164032	AC164032			
PIC12C672	8P, 8JW	PCM12XA0	DVA12XP081					AC124001	AC164301	✓			
PIC12C672	8SM	PCM12XA0	DVA12XP081	XLT08SO				AC124001	AC164312				
PIC12C672	8MF	PCM12XA0	DVA12XP081	XLT08DFN or XLT08DFN2				AC124001 +AC164032	AC164301 +AC164032	AC164032			
PIC12CE518	8P, 8JW	PCM16XA0	DVA12XP080					AC124001	AC164301	✓			
PIC12CE518	8SM	PCM16XA0	DVA12XP080	XLT08SO				AC124001	AC164312				
PIC12CE518	8SN	PCM16XA0	DVA12XP080	XLT08SO				AC164026	AC164302				
PIC12CE519	8P, 8JW	PCM16XA0	DVA12XP080					AC124001	AC164301	✓			
PIC12CE519	8SM	PCM16XA0	DVA12XP080	XLT08SO				AC124001	AC164312				
PIC12CE519	8SN	PCM16XA0	DVA12XP080	XLT08SO				AC164026	AC164302				
PIC12CE673	8P, 8JW	PCM12XA0	DVA12XP081					AC124001	AC164301	✓			
PIC12CE674	8P, 8JW	PCM12XA0	DVA12XP081					AC124001	AC164301	✓			
PIC12F508	8P	PCM16XA0	DVA12XP080					AC124001	AC164301	✓	AC162059*		DM163014, DV164101
PIC12F508	8SN	PCM16XA0	DVA12XP080	XLT08SO				AC164026	AC164302		AC162059* +XLT08SO		
PIC12F508	8ST	PCM16XA0	DVA12XP080						AC164306				
PIC12F508	8MS	PCM16XA0	DVA12XP080										
PIC12F509	8P	PCM16XA0	DVA12XP080					AC124001	AC164301	✓	AC162059*		DM163014, DV164101
PIC12F509	8SN	PCM16XA0	DVA12XP080	XLT08SO				AC164026	AC164302		AC162059* +XLT08SO		
PIC12F509	8ST	PCM16XA0	DVA12XP080						AC164306				
PIC12F509	8MS	PCM16XA0	DVA12XP080										
PIC12F629	8P	PCM12XB0	DVA12XP081					AC124001	AC164301	✓	AC162050		DM163014, DV164101*
PIC12F629	8SN	PCM12XB0	DVA12XP081	XLT08SO				AC164026	AC164302		AC162050 +XLT08SO		
PIC12F629	8MF	PCM12XB0	DVA12XP081	XLT08DFN or XLT08DFN2				AC124001 +AC164032	AC164301 +AC164032	AC164032	AC162050 +XLT08DFN or XLT08DFN2		

NOTE: See complete list of notes on page 80.

MPLAB® ICE 2000 and MPLAB® ICE 4000 Emulator Systems, PRO MATE® II Programmer Socket Modules, MPLAB® In-Circuit Debugger, Software Tools, Programmers and Demonstration Boards

		MPLAB® ICE 2000 System (1)			MPLAB® ICE 4000 System (2)								
Part Number	Lead Count/ Pkg Type	Processor Module	Device Adapters	Transition Socket	Processor Module	Device Adapters	Transition Socket	PRO MATE® II Socket Module (3,4)	MPLAB® PM3 Socket Module (8)	PICSTART® Plus (5)	MPLAB® ICD 2 (6)	MPLAB® CXX Compiler	Demonstration Boards or Evaluation Kits
PICmicro® Microcontroller Development Tools (continued)													
PIC12F635	8P	PCM16YM0	DVA1002	ACICE0201				AC124001	AC164301	✓	AC162057		DM163014, DV164101
PIC12F635	8SN	PCM16YM0	DVA1002	XLT08SO				AC164026	AC164302		AC162057 +XLT08SO		
PIC12F635	8MF	PCM16YM0	DVA1002	XLT08DFN or XLT08DFN2				AC124001 +AC164032	AC164301 +AC164032	AC164032	AC162050 +XLT08DFN or XLT08DFN2		
PIC12F675	8P	PCM12XB0	DVA12XP081					AC124001	AC164301	✓	AC162050		DM163014, DV164101
PIC12F675	8SN	PCM12XB0	DVA12XP081	XLT08SO				AC164026	AC164302		AC162050 +XLT08SO		
PIC12F675	8MF	PCM12XB0	DVA12XP081	XLT08DFN or XLT08DFN2				AC124001 +AC164032	AC164301 +AC164032	AC164032	AC162050 +XLT08DFN or XLT08DFN2		
PIC12F683	8P	PCM12XC0	DVA1002	ACICE0201				AC124001	AC164301	✓	AC162058		DM163014, DV164101
PIC12F683	8SN	PCM12XC0	DVA1002	XLT08SO				AC164026	AC164302		AC162058 +XLT08SO		
PIC12F683	8MF	PCM12XC0	DVA1002	XLT08DFN or XLT08DFN2				AC124001 +AC164032	AC164301 +AC164032	AC164032	AC162058 +XLT08DFN or XLT08DFN2		
PIC14000	28SP, 28JW	PCM14XA0	DVA14XP280					AC144001	AC164301	✓			DM143001
PIC14000	28SO	PCM14XA0	DVA14XP280	XLT28SO				AC144002	AC164302				
PIC14000	28SS	PCM14XA0	DVA14XP280	XLT28SS				AC144002	AC164307				
PIC16C52	18P	PCM16XA0	DVA16XP180					AC164001	AC164301	✓			DM163001
PIC16C52	18SO	PCM16XA0	DVA16XP180	XLT18SO				AC164002	AC164302				
PIC16C54/54A/ 54C	18P, 18JW	PCM16XA0	DVA16XP180					AC164001	AC164301	✓			DM163001
PIC16C54/54A/ 54C	18SO	PCM16XA0	DVA16XP180	XLT18SO				AC164002	AC164302				
PIC16C54/54A/ 54C	20SS	PCM16XA0	DVA16XP180	XLT20SS				AC164015	AC164307				
PIC16C55/55A	28P, 28JW	PCM16XA0	DVA16XP280	XLT28XP				AC164001	AC164301	✓			DM163001
PIC16C55/55A	28SP	PCM16XA0	DVA16XP280					AC164001	AC164301	✓			DM163001
PIC16C55/55A	28SO	PCM16XA0	DVA16XP280	XLT28SO				AC164002	AC164302				
PIC16C55/55A	28SS	PCM16XA0	DVA16XP280	XLT28SS2				AC164015	AC164307				
PIC16C56/56A	18P, 18JW	PCM16XA0	DVA16XP180					AC164001	AC164301	✓			DM163001
PIC16C56/56A	18SO	PCM16XA0	DVA16XP180	XLT18SO				AC164002	AC164302				
PIC16C56/56A	20SS	PCM16XA0	DVA16XP180	XLT20SS				AC164015	AC164307				

NOTE: See complete list of notes on page 80.

MPLAB® ICE 2000 and MPLAB® ICE 4000 Emulator Systems, PRO MATE® II Programmer Socket Modules, MPLAB® In-Circuit Debugger, Software Tools, Programmers and Demonstration Boards

		MPLAB® ICE 2000 System (1)			MPLAB® ICE 4000 System (2)								
Part Number	Lead Count/ Pkg Type	Processor Module	Device Adapters	Transition Socket	Processor Module	Device Adapters	Transition Socket	PRO MATE® II Socket Module (3,4)	MPLAB® PM3 Socket Module (8)	PICSTART® Plus (5)	MPLAB® ICD 2 (6)	MPLAB® CXX Compiler	Demonstration Boards or Evaluation Kits
PICmicro® Microcontroller Development Tools (continued)													
PIC16C57/57C	28P, 28JW	PCM16XA0	DVA16XP280	XLT28XP				AC164001	AC164301	✓			DM163001
PIC16C57/57C	28SP	PCM16XA0	DVA16XP280					AC164001	AC164301	✓			DM163001
PIC16C57/57C	28SO	PCM16XA0	DVA16XP280	XLT28SO				AC164002	AC164302				
PIC16C57/57C	28SS	PCM16XA0	DVA16XP280	XLT28SS2				AC164015	AC164307				
PIC16C58A/58B	18P, 18JW	PCM16XA0	DVA16XP180					AC164001	AC164301	✓			DM163001
PIC16C58A/58B	18SO	PCM16XA0	DVA16XP180	XLT18SO				AC164002	AC164302				
PIC16C58A/58B	20SS	PCM16XA0	DVA16XP180	XLT20SS				AC164015	AC164307				
PIC16C62A	28P, 28JW	PCM16XB1	DVA16XP282					AC164012	AC164301	✓			DM163022
PIC16C62A	28SO	PCM16XB1	DVA16XP282	XLT28SO				AC164017	AC164302				
PIC16C62A	28SS	PCM16XB1	DVA16XP282	XLT28SS				AC164021	AC164307				
PIC16C62B	28SP, 28JW	PCM16XE1	DVA16XP282					AC164012	AC164301	✓			DM163022
PIC16C62B	28ML	PCM16XE1	DVA16XP282	XLT28QFN4*				AC164012 +AC164031	AC164301 +AC164031	AC164031			
PIC16C62B	28SO	PCM16XE1	DVA16XP282	XLT28SO				AC164017	AC164302				
PIC16C62B	28SS	PCM16XE1	DVA16XP282	XLT28SS				AC164021	AC164307				
PIC16C63	28SP, 28JW	PCM16XB1	DVA16XP282					AC164012	AC164301	✓			DM163022, DVMCPA
PIC16C63	28SO	PCM16XB1	DVA16XP282	XLT28SO				AC164017	AC164302				
PIC16C63A	28SP, 28JW	PCM16XE1	DVA16XP282					AC164012	AC164301	✓			DM163022
PIC16C63A	28ML	PCM16XE1	DVA16XP282	XLT28QFN4*				AC164012 +AC164031	AC164301 +AC164031	AC164031			
PIC16C63A	28SO	PCM16XE1	DVA16XP282	XLT28SO				AC164017	AC164302				
PIC16C63A	28SS	PCM16XE1	DVA16XP282	XLT28SS				AC164021	AC164307				
PIC16C64A	40P, 40JW	PCM16XB1	DVA16XP401					AC164012	AC164301	✓			DM163022
PIC16C64A	44L	PCM16XB1	DVA16XL441					AC164013	AC164309				
PIC16C64A	44PQ	PCM16XB1	DVA16PQ441	XLT44PT or XLT44PT3				AC164014	AC164311				
PIC16C64A	44PT	PCM16XB1	DVA16PQ441	XLT44PT or XLT44PT3				AC164020	AC164305				

NOTE: See complete list of notes on page 80.

MPLAB® ICE 2000 and MPLAB® ICE 4000 Emulator Systems, PRO MATE® II Programmer Socket Modules, MPLAB® In-Circuit Debugger, Software Tools, Programmers and Demonstration Boards

		MPLAB® ICE 2000 System (1)			MPLAB® ICE 4000 System (2)								
Part Number	Lead Count/ Pkg Type	Processor Module	Device Adapters	Transition Socket	Processor Module	Device Adapters	Transition Socket	PRO MATE® II Socket Module (3,4)	MPLAB® PM3 Socket Module (8)	PICSTART® Plus (5)	MPLAB® ICD 2 (6)	MPLAB® CXX Compiler	Demonstration Boards or Evaluation Kits
PICmicro® Microcontroller Development Tools (continued)													
PIC16C65A	40P, 40JW	PCM16XB1	DVA16XP401					AC164012	AC164301	✓			DM163022
PIC16C65A	44L	PCM16XB1	DVA16XL441					AC164013	AC164309				
PIC16C65A	44PQ	PCM16XB1	DVA16PQ441	XLT44PT or XLT44PT3				AC164014	AC164311				
PIC16C65A	44PT	PCM16XB1	DVA16PQ441	XLT44PT or XLT44PT3				AC164020	AC164305				
PIC16C65B	40P, 40JW	PCM16XE1	DVA16XP401					AC164012	AC164301	✓			DM163022
PIC16C65B	44L	PCM16XE1	DVA16XL441					AC164013	AC164309				
PIC16C65B	44PQ	PCM16XE1	DVA16PQ441	XLT44PT or XLT44PT3				AC164014	AC164311				
PIC16C65B	44PT	PCM16XE1	DVA16PQ441	XLT44PT or XLT44PT3				AC164020	AC164305				
PIC16C66	28SP, 28JW	PCM16XE1	DVA16XP282					AC164012	AC164301	✓			DM163022
PIC16C66	28SO	PCM16XE1	DVA16XP282	XLT28SO				AC164017	AC164302				
PIC16C67	40P, 40JW	PCM16XE1	DVA16XP401					AC164012	AC164301	✓			DM163022
PIC16C67	44L	PCM16XE1	DVA16XL441					AC164013	AC164309				
PIC16C67	44PQ	PCM16XE1	DVA16PQ441	XLT44PT or XLT44PT3				AC164014	AC164311				
PIC16C67	44PT	PCM16XE1	DVA16PQ441	XLT44PT or XLT44PT3				AC164020	AC164305				
PIC16C71	18P, 18JW	PCM16XF0	DVA16XP180					AC164010	AC164301	✓			DM163001
PIC16C71	18SO	PCM16XF0	DVA16XP180	XLT18SO				AC164010	AC164302				
PIC16C72	28SP, 28JW	PCM16XB1	DVA16XP282					AC164012	AC164301	✓			DM163022
PIC16C72	28SO	PCM16XB1	DVA16XP282	XLT28SO				AC164017	AC164302				
PIC16C72	28SS	PCM16XB1	DVA16XP282	XLT28SS				AC164021	AC164307				
PIC16C72A	28SP, 28JW	PCM16XE1	DVA16XP282					AC164012	AC164301	✓			DM163022
PIC16C72A	28ML	PCM16XE1	DVA16XP282	XLT28QFN4*				AC164012 +AC164031	AC164301 +AC164031	AC164031			
PIC16C72A	28SO	PCM16XE1	DVA16XP282	XLT28SO				AC164017	AC164302				
PIC16C72A	28SS	PCM16XE1	DVA16XP282	XLT28SS				AC164021	AC164307				
PIC16C73A	28SP, 28JW	PCM16XB1	DVA16XP282					AC164012	AC164301	✓			DM163022
PIC16C73A	28SO	PCM16XB1	DVA16XP282	XLT28SO				AC164017	AC164302				

NOTE: See complete list of notes on page 80.

MPLAB® ICE 2000 and MPLAB® ICE 4000 Emulator Systems, PRO MATE® II Programmer Socket Modules, MPLAB® In-Circuit Debugger, Software Tools, Programmers and Demonstration Boards

		MPLAB® ICE 2000 System (1)			MPLAB® ICE 4000 System (2)								
Part Number	Lead Count/ Pkg Type	Processor Module	Device Adapters	Transition Socket	Processor Module	Device Adapters	Transition Socket	PRO MATE® II Socket Module (3,4)	MPLAB® PM3 Socket Module (8)	PICSTART® Plus (5)	MPLAB® ICD 2 (6)	MPLAB® CXX Compiler	Demonstration Boards or Evaluation Kits
PICmicro® Microcontroller Development Tools (continued)													
PIC16C73B	28SP, 28JW	PCM16XE1	DVA16XP282					AC164012	AC164301	✓			DM163022
PIC16C73B	28ML	PCM16XE1	DVA16XP282	XLT28QFN4*				AC164012 +AC164031	AC164301 +AC164031	AC164031			
PIC16C73B	28SO	PCM16XE1	DVA16XP282	XLT28SO				AC164017	AC164302				
PIC16C73B	28SS	PCM16XE1	DVA16XP282	XLT28SS				AC164021	AC164307				
PIC16C74A	40P, 40JW	PCM16XB1	DVA16XP401					AC164012	AC164301	✓			DM163022
PIC16C74A	44L	PCM16XB1	DVA16XL441					AC164013	AC164309				
PIC16C74A	44PQ	PCM16XB1	DVA16PQ441	XLT44PT or XLT44PT3				AC164014	AC164311				
PIC16C74A	44PT	PCM16XB1	DVA16PQ441	XLT44PT or XLT44PT3				AC164020	AC164305				
PIC16C74B	40P, 40JW	PCM16XE1	DVA16XP401					AC164012	AC164301	✓			DM163022
PIC16C74B	44L	PCM16XE1	DVA16XL441					AC164013	AC164309				
PIC16C74B	44PQ	PCM16XE1	DVA16PQ441	XLT44PT or XLT44PT3				AC164014	AC164311				
PIC16C74B	44PT	PCM16XE1	DVA16PQ441	XLT44PT or XLT44PT3				AC164020	AC164305				
PIC16C76	28SP, 28JW	PCM16XE1	DVA16XP282					AC164012	AC164301	✓			DM163022
PIC16C76	28SO	PCM16XE1	DVA16XP282	XLT28SO				AC164017	AC164302				
PIC16C77	40P, 40JW	PCM16XE1	DVA16XP401					AC164012	AC164301	✓			DM163022
PIC16C77	44L	PCM16XE1	DVA16XL441					AC164013	AC164309				
PIC16C77	44PQ	PCM16XE1	DVA16PQ441	XLT44PT or XLT44PT3				AC164014	AC164311				
PIC16C77	44PT	PCM16XE1	DVA16PQ441	XLT44PT or XLT44PT3				AC164020	AC164305				
PIC16C432	20P, 20JW	PCM16YB0	DVA16XP201					AC164029	AC164301				DM163005
PIC16C432	20SS	PCM16YB0	DVA16XP201	XLT20SS1				AC164029	AC164307				DM163007, DM163011
PIC16C433	18P, 18JW	PCM16YC0	DVA16XP185					AC164030	AC164301				DM163005
PIC16C433	18SO	PCM16YC0	DVA16XP185	XLT18SO				AC164030	AC164307				
PIC16C505	14P, 14JW	PCM16XA0	DVA16XP140					AC124001	AC164301	✓			
PIC16C505	14SL	PCM16XA0	DVA16XP140	XLT14SO				AC164026	AC164302				
PIC16C554	18P, 18JW	PCM16XC0	DVA16XP180					AC164010	AC164301	✓			DM163001
PIC16C554	18SO	PCM16XC0	DVA16XP180	XLT18SO				AC164010	AC164302				
PIC16C554	20SS	PCM16XC0	DVA16XP180	XLT20SS				AC164018	AC164307				

NOTE: See complete list of notes on page 80.

MPLAB® ICE 2000 and MPLAB® ICE 4000 Emulator Systems, PRO MATE® II Programmer Socket Modules, MPLAB® In-Circuit Debugger, Software Tools, Programmers and Demonstration Boards

		MPLAB® ICE 2000 System (1)			MPLAB® ICE 4000 System (2)								
Part Number	Lead Count/ Pkg Type	Processor Module	Device Adapters	Transition Socket	Processor Module	Device Adapters	Transition Socket	PRO MATE® II Socket Module (3,4)	MPLAB® PM3 Socket Module (8)	PICSTART® Plus (5)	MPLAB® ICD 2 (6)	MPLAB® CXX Compiler	Demonstration Boards or Evaluation Kits
PICmicro® Microcontroller Development Tools (continued)													
PIC16C557	28P							AC164001	AC164301				
PIC16C557	28SO							AC164002	AC164302				
PIC16C558	18P, 18JW	PCM16XC0	DVA16XP180					AC164010	AC164301	✓			DM163001
PIC16C558	18SO	PCM16XC0	DVA16XP180	XLT18SO				AC164010	AC164302				
PIC16C558	20SS	PCM16XC0	DVA16XP180	XLT20SS				AC164018	AC164307				
PIC16C620/ 620A	18P, 18JW	PCM16XC0	DVA16XP180					AC164010	AC164301	✓			DM163001
PIC16C620/ 620A	18SO	PCM16XC0	DVA16XP180	XLT18SO				AC164010	AC164302				
PIC16C620/ 620A	20SS	PCM16XC0	DVA16XP180	XLT20SS				AC164018	AC164307				
PIC16C621/ 621A	18P, 18JW	PCM16XC0	DVA16XP180					AC164010	AC164301	✓			DM163001
PIC16C621/ 621A	18SO	PCM16XC0	DVA16XP180	XLT18SO				AC164010	AC164302				
PIC16C621/ 621A	20SS	PCM16XC0	DVA16XP180	XLT20SS				AC164018	AC164307				
PIC16C622/ 622A	18P, 18JW	PCM16XC0	DVA16XP180					AC164010	AC164301	✓			DM163001
PIC16C622/ 622A	18SO	PCM16XC0	DVA16XP180	XLT18SO				AC164010	AC164302				
PIC16C622/ 622A	20SS	PCM16XC0	DVA16XP180	XLT20SS				AC164018	AC164307				
PIC16C642	28SP, 28JW	PCM16XD0	DVA16XP282					AC164012	AC164301	✓			DM163022
PIC16C642	28SO	PCM16XD0	DVA16XP282	XLT28SO				AC164017	AC164302				
PIC16C662	40P, 40JW	PCM16XD0	DVA16XP401					AC164012	AC164301	✓			DM163022
PIC16C662	44L	PCM16XD0	DVA16XL441					AC164013	AC164309				
PIC16C662	44PQ	PCM16XD0	DVA16PQ441	XLT44PT or XLT44PT3				AC164014	AC164311				
PIC16C662	44PT	PCM16XD0	DVA16PQ441	XLT44PT or XLT44PT3				AC164020	AC164305				
PIC16C710	18P, 18JW	PCM16XF0	DVA16XP180					AC164010	AC164301	✓			DM163001
PIC16C710	18SO	PCM16XF0	DVA16XP180	XLT18SO				AC164010	AC164302				
PIC16C710	20SS	PCM16XF0	DVA16XP180	XLT20SS				AC164018	AC164307				

NOTE: See complete list of notes on page 80.

MPLAB® ICE 2000 and MPLAB® ICE 4000 Emulator Systems, PRO MATE® II Programmer Socket Modules, MPLAB® In-Circuit Debugger, Software Tools, Programmers and Demonstration Boards

		MPLAB® ICE 2000 System (1)			MPLAB® ICE 4000 System (2)								
Part Number	Lead Count/ Pkg Type	Processor Module	Device Adapters	Transition Socket	Processor Module	Device Adapters	Transition Socket	PRO MATE® II Socket Module (3,4)	MPLAB® PM3 Socket Module (8)	PICSTART® Plus (5)	MPLAB® ICD 2 (6)	MPLAB® CXX Compiler	Demonstration Boards or Evaluation Kits
PICmicro® Microcontroller Development Tools (continued)													
PIC16C711	18P, 18JW	PCM16XF0	DVA16XP180					AC164010	AC164301	✓			DM163001
PIC16C711	18SO	PCM16XF0	DVA16XP180	XLT18SO				AC164010	AC164302				
PIC16C711	20SS	PCM16XF0	DVA16XP180	XLT20SS				AC164018	AC164307				
PIC16C712	18P, 18JW	PCM16XE1	DVA16XP182					AC164010	AC164301	✓			DM163001
PIC16C712	18SO	PCM16XE1	DVA16XP182	XLT18SO				AC164010	AC164302				
PIC16C712	20SS	PCM16XE1	DVA16XP182	XLT20SS				AC164018	AC164307				
PIC16C715	18P, 18JW	PCM16XG0	DVA16XP180					AC164010	AC164301	✓			DM163001
PIC16C715	18SO	PCM16XG0	DVA16XP180	XLT18SO				AC164010	AC164302				
PIC16C715	20SS	PCM16XG0	DVA16XP180	XLT20SS				AC164018	AC164307				
PIC16C716	18P, 18JW	PCM16XE1	DVA16XP182					AC164010	AC164301	✓			DM163001
PIC16C716	18SO	PCM16XE1	DVA16XP182	XLT18SO				AC164010	AC164302				
PIC16C716	20SS	PCM16XE1	DVA16XP182	XLT20SS				AC164018	AC164307				
PIC16C717	18P, 18JW	PCM16XN1	DVA18XP180					AC164010	AC164301	✓			DM163001
PIC16C717	18SO	PCM16XN1	DVA18XP180	XLT18SO				AC164010	AC164302				
PIC16C717	20SS	PCM16XN1	DVA18XP180	XLT20SS				AC164018	AC164307				
PIC16C745	28SP, 28JW	PCM16XQ1	DVA16XP282					AC164012	AC164301	✓			DM163010
PIC16C745	28SO	PCM16XQ1	DVA16XP282	XLT28SO				AC164017	AC164302				
PIC16C765	40P, 40JW	PCM16XQ1	DVA16XP401					AC164012	AC164301	✓			DM163010
PIC16C765	44L	PCM16XQ1	DVA16XL441					AC164013	AC164309				
PIC16C765	44PT	PCM16XQ1	DVA16PQ441	XLT44PT or XLT44PT3				AC164020	AC164305				
PIC16C770	20P, 20JW	PCM16XN1	DVA16XP200					AC164028	AC164301	✓			DM163001
PIC16C770	20SO	PCM16XN1	DVA16XP200	XLT20SO1				AC164028	AC164302				
PIC16C770	20SS	PCM16XN1	DVA16XP200	XLT20SS1				AC164018	AC164307				
PIC16C771	20P, 20JW	PCM16XN1	DVA16XP200					AC164028	AC164301	✓			DM163001
PIC16C771	20SO	PCM16XN1	DVA16XP200	XLT20SO1				AC164028	AC164302				
PIC16C771	20SS	PCM16XN1	DVA16XP200	XLT20SS1				AC164018	AC164307				
PIC16C773	28SP, 28JW	PCM16XL0	DVA16XP282					AC164012	AC164301	✓			DM163022
PIC16C773	28SO	PCM16XL0	DVA16XP282	XLT28SO				AC164017	AC164302				
PIC16C773	28SS	PCM16XL0	DVA16XP282	XLT28SS				AC164021	AC164307				

NOTE: See complete list of notes on page 80.

MPLAB® ICE 2000 and MPLAB® ICE 4000 Emulator Systems, PRO MATE® II Programmer Socket Modules, MPLAB® In-Circuit Debugger, Software Tools, Programmers and Demonstration Boards

		MPLAB® ICE 2000 System (1)			MPLAB® ICE 4000 System (2)								
Part Number	Lead Count/ Pkg Type	Processor Module	Device Adapters	Transition Socket	Processor Module	Device Adapters	Transition Socket	PRO MATE® II Socket Module (3,4)	MPLAB® PM3 Socket Module (8)	PICSTART® Plus (5)	MPLAB® ICD 2 (6)	MPLAB® CXX Compiler	Demonstration Boards or Evaluation Kits
PICmicro® Microcontroller Development Tools (continued)													
PIC16C774	40P, 40JW	PCM16XL0	DVA16XP401					AC164012	AC164301	✓			DM163022
PIC16C774	44L	PCM16XL0	DVA16XL441					AC164013	AC164309				
PIC16C774	44PQ	PCM16XL0	DVA16PQ441	XLT44PT or XLT44PT3				AC164014	AC164311				
PIC16C774	44PT	PCM16XL0	DVA16PQ441	XLT44PT or XLT44PT3				AC164020	AC164305				
PIC16C781	20P, 20JW	PCM16XW0	DVA16XP202					AC164028	AC164301	✓			DM163012
PIC16C781	20SO	PCM16XW0	DVA16XP202	XLT20SO1				AC164028	AC164302				
PIC16C781	20SS	PCM16XW0	DVA16XP202	XLT20SS1				AC164018	AC164307				
PIC16C782	20P, 20JW	PCM16XW0	DVA16XP202					AC164028	AC164301	✓			DM163012
PIC16C782	20SO	PCM16XW0	DVA16XP202	XLT20SO1				AC164028	AC164302				
PIC16C782	20SS	PCM16XW0	DVA16XP202	XLT20SS1				AC164018	AC164307				
PIC16C923	64SP	PCM16XJ0	DVA16XP640					AC164025		✓			
PIC16C923	64PT	PCM16XJ0	DVA16PQ640	XLT64PT1				AC164023	AC164319				
PIC16C923	68L, 68CL	PCM16XJ0	DVA16XL680					AC164022	AC164308	AC164024			DM163003
PIC16C924	64SP	PCM16XJ0	DVA16XP640					AC164025		✓			
PIC16C924	64PT	PCM16XJ0	DVA16PQ640	XLT64PT1				AC164023	AC164319				
PIC16C924	68L, 68CL	PCM16XJ0	DVA16XL680					AC164022	AC164308	AC164024			DM163003
PIC16C925	64PT	PCM16XT0	DVA16PQ640	XLT64PT1				AC164023	AC164319				
PIC16C925	68L, 68CL	PCM16XT0	DVA16XL680					AC164022	AC164308	AC164024			DM163003
PIC16C926	64PT	PCM16XT0	DVA16PQ640	XLT64PT1				AC164023	AC164319				
PIC16C926	68L, 68CL	PCM16XT0	DVA16XL680					AC164022	AC164308	AC164024			DM163003
PIC16CE623	18P, 18JW	PCM16XC0	DVA16XP180					AC164010	AC164301	✓			DM163001
PIC16CE623	18SO	PCM16XC0	DVA16XP180	XLT18SO				AC164010	AC164302				
PIC16CE623	20SS	PCM16XC0	DVA16XP180	XLT20SS				AC164018	AC164307				
PIC16CE624	18P, 18JW	PCM16XC0	DVA16XP180					AC164010	AC164301	✓			DM163001
PIC16CE624	18SO	PCM16XC0	DVA16XP180	XLT18SO				AC164010	AC164302				
PIC16CE624	20SS	PCM16XC0	DVA16XP180	XLT20SS				AC164018	AC164307				
PIC16CE625	18P, 18JW	PCM16XC0	DVA16XP180					AC164010	AC164301	✓			DM163001
PIC16CE625	18SO	PCM16XC0	DVA16XP180	XLT18SO				AC164010	AC164302				
PIC16CE625	20SS	PCM16XC0	DVA16XP180	XLT20SS				AC164018	AC164307				

NOTE: See complete list of notes on page 80.

MPLAB® ICE 2000 and MPLAB® ICE 4000 Emulator Systems, PRO MATE® II Programmer Socket Modules, MPLAB® In-Circuit Debugger, Software Tools, Programmers and Demonstration Boards

		MPLAB® ICE 2000 System (1)			MPLAB® ICE 4000 System (2)								
Part Number	Lead Count/ Pkg Type	Processor Module	Device Adapters	Transition Socket	Processor Module	Device Adapters	Transition Socket	PRO MATE® II Socket Module (3,4)	MPLAB® PM3 Socket Module (8)	PICSTART® Plus (5)	MPLAB® ICD 2 (6)	MPLAB® CXX Compiler	Demonstration Boards or Evaluation Kits
PICmicro® Microcontroller Development Tools (continued)													
PIC16F54	18P	PCM16XA0	DVA16XP180					AC164001	AC164301	✓	✓*		DM163001
PIC16F54	18SO	PCM16XA0	DVA16XP180	XLT18SO				AC164002	AC164302	✓	✓*		
PIC16F54	20SS	PCM16XA0	DVA16XP180	XLT20SS				AC164015	AC164307	✓	✓*		
PIC16F57	28P	PCM16XA0	DVA16XP280	XLT28XP				AC164001	AC164301	✓	✓*		DM163001
PIC16F57	28SP	PCM16XA0	DVA16XP280					AC164001	AC164301	✓	✓*		
PIC16F57	28SO	PCM16XA0	DVA16XP280	XLT28SO				AC164002	AC164302	✓	✓*		
PIC16F57	28SS	PCM16XA0	DVA16XP280	XLT28SS2				AC164015	AC164307	✓	✓*		
PIC16F72	28SP, 28JW	PCM16XS2	DVA16XP282					AC164012	AC164301	✓			DM163022
PIC16F72	28SO	PCM16XS2	DVA16XP282	XLT28SO				AC164017	AC164302				
PIC16F72	28SS	PCM16XS2	DVA16XP282	XLT28SS				AC164021	AC164307				
PIC16F72	28ML	PCM16XS2	DVA16XP282	XLT28QFN4*				AC164012 +AC164031	AC164301 +AC164031	AC164031			
PIC16F73	28SP, 28JW	PCM16XS2	DVA16XP282					AC164012	AC164301	✓	✓*		DM163022
PIC16F73	28ML	PCM16XS2	DVA16XP282	XLT28QFN4*				AC164012 +AC164031	AC164301 +AC164031	AC164031	✓*		
PIC16F73	28SO	PCM16XS2	DVA16XP282	XLT28SO				AC164017	AC164302		✓*		
PIC16F73	28SS	PCM16XS2	DVA16XP282	XLT28SS				AC164021	AC164307		✓*		
PIC16F74	40P	PCM16XS2	DVA16XP401					AC164012	AC164301	✓	✓*		DM163022
PIC16F74	44L	PCM16XS2	DVA16XL441					AC164013	AC164309		✓*		
PIC16F74	44PT	PCM16XS2	DVA16PQ441	XLT44PT or XLT44PT3				AC164020	AC164305		✓*		
PIC16F74	44ML	PCM16XS2	DVA16XL441	XLT44QFN2				AC164012 +AC164034	AC164301 +AC164034	AC164034	✓*		
PIC16F76	28SP, 28JW	PCM16XS2	DVA16XP282					AC164012	AC164301	✓	✓*		DM163022
PIC16F76	28ML	PCM16XS2	DVA16XP282	XLT28QFN4*				AC164012 +AC164031	AC164301 +AC164031	AC164031	✓*		
PIC16F76	28SO	PCM16XS2	DVA16XP282	XLT28SO				AC164017	AC164302		✓*		
PIC16F76	28SS	PCM16XS2	DVA16XP282	XLT28SS				AC164021	AC164307		✓*		
PIC16F77	40P, 40JW	PCM16XS2	DVA16XP401					AC164012	AC164301	✓	✓*		DM163022
PIC16F77	44L	PCM16XS2	DVA16XL441					AC164013	AC164309		✓*		
PIC16F77	44ML	PCM16XS2	DVA16XL441	XLT44QFN2				AC164012 +AC164034	AC164301 +AC164034	AC164034	✓*		
PIC16F77	44PT	PCM16XS2	DVA16PQ441	XLT44PT or XLT44PT3				AC164020	AC164305		✓*		

NOTE: See complete list of notes on page 80.

MPLAB® ICE 2000 and MPLAB® ICE 4000 Emulator Systems, PRO MATE® II Programmer Socket Modules, MPLAB® In-Circuit Debugger, Software Tools, Programmers and Demonstration Boards

		MPLAB® ICE 2000 System (1)			MPLAB® ICE 4000 System (2)								
Part Number	Lead Count/ Pkg Type	Processor Module	Device Adapters	Transition Socket	Processor Module	Device Adapters	Transition Socket	PRO MATE® II Socket Module (3,4)	MPLAB® PM3 Socket Module (8)	PICSTART® Plus (5)	MPLAB® ICD 2 (6)	MPLAB® CXX Compiler	Demonstration Boards or Evaluation Kits
PICmicro® Microcontroller Development Tools (continued)													
PIC16F83	18P	PCM16XH1	DVA16XP180					AC164010	AC164301	✓			DM163001
PIC16F83	18SO	PCM16XH1	DVA16XP180	XLT18SO				AC164010	AC164302				
PIC16F84	18P	PCM16XH1	DVA16XP180					AC164010	AC164301	✓			DM163001
PIC16F84	18SO	PCM16XH1	DVA16XP180	XLT18SO				AC164010	AC164302				
PIC16F84A	18P	PCM16XH1	DVA16XP180					AC164010	AC164301	✓			DM163001
PIC16F84A	18SO	PCM16XH1	DVA16XP180	XLT18SO				AC164010	AC164302				
PIC16F84A	20SS	PCM16XH1	DVA16XP180	XLT20SS				AC164018	AC164307				
PIC16F87	18P	PCM16YG0	DVA16XP186					AC164010	AC164301	✓	✓		DM163014
PIC16F87	18SO	PCM16YG0	DVA16XP186	XLT18SO				AC164010	AC164302		✓		
PIC16F87	20SS	PCM16YG0	DVA16XP186	XLT20SS				AC164018	AC164307		✓		
PIC16F87	28ML	PCM16YG0	DVA16XP186	XLT28QFN3				AC164010 +AC164033	AC164301 +AC164031	AC164033	✓		
PIC16F88	18P	PCM16YG0	DVA16XP186					AC164010	AC164301	✓	✓		DM163014
PIC16F88	18SO	PCM16YG0	DVA16XP186	XLT18SO				AC164010	AC164302		✓		
PIC16F88	20SS	PCM16YG0	DVA16XP186	XLT20SS				AC164018	AC164307		✓		
PIC16F88	28ML	PCM16YG0	DVA16XP186	XLT28QFN3				AC164010 +AC164033	AC164301 +AC164031	AC164033	✓		
PIC16F505	14P, 14JW	PCM16XA0	DVA16XP140					AC124001	AC164301	✓	AC162059		DM163014, DV164101*
PIC16F505	14SL	PCM16XA0	DVA16XP140	XLT14SO				AC164026	AC164302		AC162059 +XLT14SO		
PIC16F505	14ST	PCM16XA0	DVA16XP140						AC164306				
PIC16F627	18P, 18JW	PCM16XP0	DVA16XP183					AC164010	AC164301	✓			DM163001
PIC16F627	18SO	PCM16XP0	DVA16XP183	XLT18SO				AC164010	AC164302				
PIC16F627	20SS	PCM16XP0	DVA16XP183	XLT20SS				AC164018	AC164307				
PIC16F627A	18P	PCM16YF0	DVA16XP186					AC164010	AC164301	✓	AC162053		DM163014
PIC16F627A	18SO	PCM16YF0	DVA16XP186	XLT18SO				AC164010	AC164302		AC162053 +XLT18SO		
PIC16F627A	20SS	PCM16YF0	DVA16XP186	XLT20SS				AC164018	AC164307		AC162053 +XLT20SS		
PIC16F627A	28ML	PCM16YF0	DVA16XP186	XLT28QFN3				AC164010 +AC164033	AC164301 +AC164031	AC164033	AC162053 +XLT28QFN3		
PIC16F628	18P, 18JW	PCM16XP0	DVA16XP183					AC164010	AC164301	✓			DM163001
PIC16F628	18SO	PCM16XP0	DVA16XP183	XLT18SO				AC164010	AC164302				
PIC16F628	20SS	PCM16XP0	DVA16XP183	XLT20SS				AC164018	AC164307				

NOTE: See complete list of notes on page 80.

MPLAB® ICE 2000 and MPLAB® ICE 4000 Emulator Systems, PRO MATE® II Programmer Socket Modules, MPLAB® In-Circuit Debugger, Software Tools, Programmers and Demonstration Boards

		MPLAB® ICE 2000 System (1)			MPLAB® ICE 4000 System (2)								
Part Number	Lead Count/ Pkg Type	Processor Module	Device Adapters	Transition Socket	Processor Module	Device Adapters	Transition Socket	PRO MATE® II Socket Module (3,4)	MPLAB® PM3 Socket Module (8)	PICSTART® Plus (5)	MPLAB® ICD 2 (6)	MPLAB® CXX Compiler	Demonstration Boards or Evaluation Kits
PICmicro® Microcontroller Development Tools (continued)													
PIC16F628A	18P	PCM16YF0	DVA16XP186					AC164010	AC164301	✓	AC162053		DM163014
PIC16F628A	18SO	PCM16YF0	DVA16XP186	XLT18SO				AC164010	AC164302		AC162053 +XLT18SO		
PIC16F628A	20SS	PCM16YF0	DVA16XP186	XLT20SS				AC164018	AC164307		AC162053 +XLT20SS		
PIC16F628A	28ML	PCM16YF0	DVA16XP186	XLT28QFN3				AC164010 +AC164033	AC164301 +AC164031	AC164033	AC162053 +XLT28QFN3		
PIC16F630	14P	PCM16YD0	DVA16XP141					AC124001	AC164301	✓	AC162052		DM163014, DV164101*
PIC16F630	14SL	PCM16YD0	DVA16XP141	XLT14SO				AC164026	AC164302		AC162052 +XLT14SO		
PIC16F630	14ST	PCM16YD0	DVA16XP141	XLT14SS				AC164026	AC164306		AC162052 +XLT14SS		
PIC16F636	14P	PCM16YM0	DVA1002	ACICE0207				AC124001	AC164301	✓	AC162057		
PIC16F636	14SL	PCM16YM0	DVA1002	XLT14SO				AC164026	AC164302		AC162057 +XLT14SO		
PIC16F636	14ST	PCM16YM0	DVA1002	XLT14SS				AC164026	AC164306		AC162057 +XLT14SS		
PIC16F639	20P	PCM16YM0*	DVA1002	ACICE0203				TBD	AC164301*	✓*	AC162066*		DV164101*, DM163014
PIC16F639	20SO	PCM16YM0*	DVA1002	XLT20SO1				TBD	AC164302*		AC162066* +XLT20SO1		
PIC16F639	20SS	PCM16YM0*	DVA1002	XLT20SS1				TBD	AC164307*		AC162066* +XLT20SS1		
PIC16F648A	18P	PCM16YF0	DVA16XP186					AC164010	AC164301	✓	AC162053		DM163014
PIC16F648A	18SO	PCM16YF0	DVA16XP186	XLT18SO				AC164010	AC164302		AC162053 +XLT18SO		
PIC16F648A	20SS	PCM16YF0	DVA16XP186	XLT20SS				AC164018	AC164307		AC162053 +XLT20SS		
PIC16F648A	28ML	PCM16YF0	DVA16XP186	XLT28QFN3				AC164010 +AC164033	AC164301 +AC164031	AC164033	AC162053 +XLT28QFN3		
PIC16F676	14P	PCM16YD0	DVA16XP141					AC124001	AC164301	✓	AC162052		DM163014, DV164101*
PIC16F676	14SL	PCM16YD0	DVA16XP141	XLT14SO				AC164026	AC164302		AC162052 +XLT14SO		
PIC16F676	14ST	PCM16YD0	DVA16XP141	XLT14SS				AC164026	AC164306		AC162052 +XLT14SS		

NOTE: See complete list of notes on page 80.

MPLAB® ICE 2000 and MPLAB® ICE 4000 Emulator Systems, PRO MATE® II Programmer Socket Modules, MPLAB® In-Circuit Debugger, Software Tools, Programmers and Demonstration Boards

		MPLAB® ICE 2000 System (1)			MPLAB® ICE 4000 System (2)								
Part Number	Lead Count/ Pkg Type	Processor Module	Device Adapters	Transition Socket	Processor Module	Device Adapters	Transition Socket	PRO MATE® II Socket Module (3,4)	MPLAB® PM3 Socket Module (8)	PICSTART® Plus (5)	MPLAB® ICD 2 (6)	MPLAB® CXX Compiler	Demonstration Boards or Evaluation Kits
PICmicro® Microcontroller Development Tools (continued)													
PIC16F684	14P	PCM16YK0	DVA1002	ACICE0207				AC124001	AC164301	✓	AC162055		DV164101*
PIC16F684	14SL	PCM16YK0	DVA1002	XLT14SO				AC164026	AC164302		AC162055 +XLT14SO		
PIC16F684	14ST	PCM16YK0	DVA1002	XLT14SS				AC164026	AC164306		AC162055 +XLT14SS		
PIC16F688	14P	PCM16YL0	DVA1002	ACICE0207				AC124001	AC164301	✓	AC162056		DV164101*
PIC16F688	14SL	PCM16YL0	DVA1002	XLT14SO				AC164026	AC164302		AC162056 +XLT14SO		
PIC16F688	14ST	PCM16YL0	DVA1002	XLT14SS				AC164026	AC164306		AC162056 +XLT14SS		
PIC16F716	18P	PCM16YJ0	DVA16XP187					AC164010	AC164301	✓	AC162054		DM163001
PIC16F716	18SO	PCM16YJ0	DVA16XP187	XLT18SO				AC164010	AC164302		AC162054 +XLT18SO		
PIC16F716	20SS	PCM16YJ0	DVA16XP187	XLT20SS				AC164018	AC164307		AC162054 +XLT20SS		
PIC16F737	28SP	PCM16YH0	DVA18XP280					AC164012	AC164301	✓	✓		
PIC16F737	28SO	PCM16YH0	DVA18XP280	XLT28SO				AC164017	AC164302		✓		
PIC16F737	28SS	PCM16YH0	DVA18XP280	XLT28SS				AC164021	AC164307		✓		
PIC16F737	28ML	PCM16YH0	DVA18XP280	XLT28QFN4*				AC164012 +AC164031	AC164301 +AC164031	AC164031	✓		
PIC16F747	40P	PCM16YH0	DVA18XP400					AC164012	AC164301	✓	✓		
PIC16F747	44PT	PCM16YH0	DVA18PQ440	XLT44PT or XLT44PT3				AC164020	AC164305		✓		
PIC16F747	44ML	PCM16YH0	DVA18XP400	XLT44QFN2				AC164012 +AC164034	AC164301 +AC164034	AC164034	✓		
PIC16F767	28P	PCM16YH0	DVA18XP280					AC164012	AC164301	✓	✓		
PIC16F767	28SO	PCM16YH0	DVA18XP280	XLT28SO				AC164017	AC164302		✓		
PIC16F767	28SS	PCM16YH0	DVA18XP280	XLT28SS				AC164021	AC164307		✓		
PIC16F767	28ML	PCM16YH0	DVA18XP280	XLT28QFN4*				AC164012 +AC164031	AC164301 +AC164031	AC164031	✓		
PIC16F777	40P	PCM16YH0	DVA18XP400					AC164012	AC164301	✓	✓		
PIC16F777	44PT	PCM16YH0	DVA18PQ440	XLT44PT or XLT44PT3				AC164020	AC164305		✓		
PIC16F777	44ML	PCM16YH0	DVA18XP400	XLT44QFN2				AC164012 +AC164034	AC164301 +AC164034	AC164034	✓		

NOTE: See complete list of notes on page 80.

MPLAB® ICE 2000 and MPLAB® ICE 4000 Emulator Systems, PRO MATE® II Programmer Socket Modules, MPLAB® In-Circuit Debugger, Software Tools, Programmers and Demonstration Boards

		MPLAB® ICE 2000 System (1)			MPLAB® ICE 4000 System (2)								
Part Number	Lead Count/ Pkg Type	Processor Module	Device Adapters	Transition Socket	Processor Module	Device Adapters	Transition Socket	PRO MATE® II Socket Module (3,4)	MPLAB® PM3 Socket Module (8)	PICSTART® Plus (5)	MPLAB® ICD 2 (6)	MPLAB® CXX Compiler	Demonstration Boards or Evaluation Kits
PICmicro® Microcontroller Development Tools (continued)													
PIC16F785	20P	PCM16YN0*	DVA1004*	ACICE0203				TBD	AC164301	✓*	AC162060*		
PIC16F785	20SO	PCM16YN0*	DVA1004*	XLT20SO1				TBD	AC164302		AC162060* +XLT20SO1		
PIC16F785	20SS	PCM16YN0*	DVA1004*	XLT20SS1				TBD	AC164307		AC162060* +XLT20SS1		
PIC16F818	18P	PCM16YE0	DVA16XP186					AC164010	AC164301	✓	✓		DM163014
PIC16F818	18SO	PCM16YE0	DVA16XP186	XLT18SO				AC164010	AC164302		✓		
PIC16F818	20SS	PCM16YE0	DVA16XP186	XLT20SS				AC164018	AC164307		✓		
PIC16F818	28ML	PCM16YE0	DVA16XP186	XLT28QFN3				AC164010 +AC164033	AC164301 +AC164031	AC164033	✓		
PIC16F819	18P	PCM16YE0	DVA16XP186					AC164010	AC164301	✓	✓		DM163014
PIC16F819	18SO	PCM16YE0	DVA16XP186	XLT18SO				AC164010	AC164302		✓		
PIC16F819	20SS	PCM16YE0	DVA16XP186	XLT20SS				AC164018	AC164307		✓		
PIC16F819	28ML	PCM16YE0	DVA16XP186	XLT28QFN3				AC164010 +AC164033	AC164301 +AC164031	AC164033	✓		
PIC16F870	28SP, 28JW	PCM16XR1	DVA16XP282					AC164012	AC164301	✓	✓		DM163022
PIC16F870	28SO	PCM16XR1	DVA16XP282	XLT28SO				AC164017	AC164302		✓		
PIC16F870	28SS	PCM16XR1	DVA16XP282	XLT28SS				AC164021	AC164307		✓		
PIC16F871	40P	PCM16XR1	DVA16XP401					AC164012	AC164301	✓	✓		DM163022
PIC16F871	44L	PCM16XR1	DVA16XL441					AC164013	AC164309		✓		
PIC16F871	44PT	PCM16XR1	DVA16PQ441	XLT44PT or XLT44PT3				AC164020	AC164305		✓		
PIC16F872	28SP	PCM16XK1	DVA16XP282					AC164012	AC164301	✓	✓		DM163022
PIC16F872	28SO	PCM16XK1	DVA16XP282	XLT28SO				AC164017	AC164302		✓		
PIC16F872	28SS	PCM16XK1	DVA16XP282	XLT28SS				AC164021	AC164307		✓		
PIC16F873	28SP	PCM16XK1	DVA16XP282					AC164012	AC164301	✓	✓		DM163022
PIC16F873	28SO	PCM16XK1	DVA16XP282	XLT28SO				AC164017	AC164302		✓		
PIC16F873A	28SP	PCM16XV0	DVA16XP282					AC164012	AC164301	✓	✓		DM163022
PIC16F873A	28SO	PCM16XV0	DVA16XP282	XLT28SO				AC164017	AC164302		✓		
PIC16F873A	28SS	PCM16XV0	DVA16XP282	XLT28SS				AC164021	AC164307		✓		
PIC16F873A	28ML	PCM16XV0	DVA16XP282	XLT28QFN4*				AC164012 +AC164031	AC164301 +AC164031	AC164031	✓		

NOTE: See complete list of notes on page 80.

MPLAB® ICE 2000 and MPLAB® ICE 4000 Emulator Systems, PRO MATE® II Programmer Socket Modules, MPLAB® In-Circuit Debugger, Software Tools, Programmers and Demonstration Boards

		MPLAB® ICE 2000 System (1)			MPLAB® ICE 4000 System (2)								
Part Number	Lead Count/ Pkg Type	Processor Module	Device Adapters	Transition Socket	Processor Module	Device Adapters	Transition Socket	PRO MATE® II Socket Module (3,4)	MPLAB® PM3 Socket Module (8)	PICSTART® Plus (5)	MPLAB® ICD 2 (6)	MPLAB® CXX Compiler	Demonstration Boards or Evaluation Kits
PICmicro® Microcontroller Development Tools (continued)													
PIC16F874	40P	PCM16XK1	DVA16XP401					AC164012	AC164301	✓	✓		DM163022
PIC16F874	44L	PCM16XK1	DVA16XL441					AC164013	AC164309		✓		
PIC16F874	44PQ	PCM16XK1	DVA16PQ441	XLT44PT or XLT44PT3				AC164014	AC164311		✓		
PIC16F874	44PT	PCM16XK1	DVA16PQ441	XLT44PT or XLT44PT3				AC164020	AC164305		✓		
PIC16F874A	40P	PCM16XV0	DVA16XP401					AC164012	AC164301	✓	✓		DM163022
PIC16F874A	44L	PCM16XV0	DVA16XL441					AC164013	AC164309		✓		
PIC16F874A	44PT	PCM16XV0	DVA16PQ441	XLT44PT or XLT44PT3				AC164020	AC164305		✓		
PIC16F874A	44ML	PCM16XV0	DVA16XP401	XLT44QFN2				AC164012 +AC164034	AC164301 +AC164034	AC164034	✓		
PIC16F876	28SP	PCM16XK1	DVA16XP282					AC164012	AC164301	✓	✓		DM163022
PIC16F876	28SO	PCM16XK1	DVA16XP282	XLT28SO				AC164017	AC164302		✓		
PIC16F876A	28SP	PCM16XV0	DVA16XP282					AC164012	AC164301	✓	✓		DM163022
PIC16F876A	28SO	PCM16XV0	DVA16XP282	XLT28SO				AC164017	AC164302		✓		
PIC16F876A	28SS	PCM16XV0	DVA16XP282	XLT28SS				AC164021	AC164307		✓		
PIC16F876A	28ML	PCM16XV0	DVA16XP282	XLT28QFN4*				AC164012 +AC164031	AC164301 +AC164031	AC164031	✓		
PIC16F877	40P	PCM16XK1	DVA16XP401					AC164012	AC164301	✓	✓		DM163022
PIC16F877	44L	PCM16XK1	DVA16XL441					AC164013	AC164309		✓		
PIC16F877	44PQ	PCM16XK1	DVA16PQ441	XLT44PT or XLT44PT3				AC164014	AC164311		✓		
PIC16F877	44PT	PCM16XK1	DVA16PQ441	XLT44PT or XLT44PT3				AC164020	AC164305		✓		
PIC16F877A	40P	PCM16XV0	DVA16XP401					AC164012	AC164301	✓	✓		DM163022
PIC16F877A	44L	PCM16XV0	DVA16XL441					AC164013	AC164309		✓		
PIC16F877A	44PT	PCM16XV0	DVA16PQ441	XLT44PT or XLT44PT3				AC164020	AC164305		✓		
PIC16F877A	44ML	PCM16XV0	DVA16XP401	XLT44QFN2				AC164012 +AC164034	AC164301 +AC164034	AC164034	✓		
PIC16F913	28P	PCM16YP0*	DVA18XP280					AC164012	AC164301	✓*	✓*		
PIC16F913	28SO	PCM16YP0*	DVA18XP280	XLT28SO				AC164017	AC164302		✓*		
PIC16F913	28SS	PCM16YP0*	DVA18XP280	XLT28SS				AC164021	AC164307		✓*		
PIC16F913	28ML	PCM16YP0*	DVA18XP280	XLT28QFN4*				AC164012 +AC164031	AC164301 +AC164031	AC164031*	✓*		

NOTE: See complete list of notes on page 80.

MPLAB® ICE 2000 and MPLAB® ICE 4000 Emulator Systems, PRO MATE® II Programmer Socket Modules, MPLAB® In-Circuit Debugger, Software Tools, Programmers and Demonstration Boards

		MPLAB® ICE 2000 System (1)			MPLAB® ICE 4000 System (2)								
Part Number	Lead Count/ Pkg Type	Processor Module	Device Adapters	Transition Socket	Processor Module	Device Adapters	Transition Socket	PRO MATE® II Socket Module (3,4)	MPLAB® PM3 Socket Module (8)	PICSTART® Plus (5)	MPLAB® ICD 2 (6)	MPLAB® CXX Compiler	Demonstration Boards or Evaluation Kits
PICmicro® Microcontroller Development Tools (continued)													
PIC16F914	40P	PCM16YP0*	DVA18XP400					AC164012	AC164301	✓*	✓*		
PIC16F914	44PT	PCM16YP0*	DVA18PQ440	XLT44PT or XLT44PT3				AC164020	AC164305		✓*		
PIC16F914	44ML	PCM16YP0*	DVA18XP400	XLT44QFN2				AC164012 +AC164034	AC164301 +AC164034	AC164034*	✓*		
PIC16F916	28P	PCM16YP0*	DVA18XP280					AC164012	AC164301	✓	✓		
PIC16F916	28SO	PCM16YP0*	DVA18XP280	XLT28SO				AC164017	AC164302		✓		
PIC16F916	28SS	PCM16YP0*	DVA18XP280	XLT28SS				AC164021	AC164307		✓		
PIC16F916	28ML	PCM16YP0*	DVA18XP280	XLT28QFN4*				AC164012 +AC164031	AC164301 +AC164031	AC164031	✓		
PIC16F917	40P	PCM16YP0*	DVA18XP400					AC164012	AC164301	✓	✓		
PIC16F917	44PT	PCM16YP0*	DVA18PQ440	XLT44PT or XLT44PT3				AC164020	AC164305		✓		
PIC16F917	44ML	PCM16YP0*	DVA18XP400	XLT44QFN2				AC164012 +AC164034	AC164301 +AC164034	AC164034	✓		
PIC16HV540	18P, 18JW							AC164001	AC164301	✓			
PIC16HV540	18SO							AC164002	AC164302				
PIC16HV540	20SS							AC164015	AC164307				
PIC17C42A	40P, 40JW	PCM17XA0	DVA17XP401					AC174001	AC164301	✓			DM163001
PIC17C42A	44L	PCM17XA0	DVA17XL441					AC174002	AC164317				
PIC17C42A	44PQ	PCM17XA0	DVA17PQ441	XLT44PT or XLT44PT3				AC174004	AC164316				
PIC17C42A	44PT	PCM17XA0	DVA17PQ441	XLT44PT or XLT44PT3				AC174005	AC164315				
PIC17C43	40P, 40JW	PCM17XA0	DVA17XP401					AC174001	AC164301	✓			DM163001
PIC17C43	44L	PCM17XA0	DVA17XL441					AC174002	AC164317				
PIC17C43	44PQ	PCM17XA0	DVA17PQ441	XLT44PT or XLT44PT3				AC174004	AC164316				
PIC17C43	44PT	PCM17XA0	DVA17PQ441	XLT44PT or XLT44PT3				AC174005	AC164315				

NOTE: See complete list of notes on page 80.

MPLAB® ICE 2000 and MPLAB® ICE 4000 Emulator Systems, PRO MATE® II Programmer Socket Modules, MPLAB® In-Circuit Debugger, Software Tools, Programmers and Demonstration Boards

		MPLAB® ICE 2000 System (1)			MPLAB® ICE 4000 System (2)								
Part Number	Lead Count/ Pkg Type	Processor Module	Device Adapters	Transition Socket	Processor Module	Device Adapters	Transition Socket	PRO MATE® II Socket Module (3,4)	MPLAB® PM3 Socket Module (8)	PICSTART® Plus (5)	MPLAB® ICD 2 (6)	MPLAB® CXX Compiler	Demonstration Boards or Evaluation Kits
PICmicro® Microcontroller Development Tools (continued)													
PIC17C44	40P, 40JW	PCM17XA0	DVA17XP401					AC174001	AC164301	✓			DM163001
PIC17C44	44L	PCM17XA0	DVA17XL441					AC174002	AC164317				
PIC17C44	44PQ	PCM17XA0	DVA17PQ441	XLT44PT or XLT44PT3				AC174004	AC164316				
PIC17C44	44PT	PCM17XA0	DVA17PQ441	XLT44PT or XLT44PT3				AC174005	AC164315				
PIC17C752	68L	PCM17XA0	DVA17XL681					AC174007	AC164308*	AC164024			DM173001
PIC17C752	64PT	PCM17XA0	DVA17PQ641	XLT64PT2 or XLT64PT5				AC174008	AC164319*				
PIC17C756/ 756A	68L, 68CL	PCM17XA0	DVA17XL681					AC174007	AC164308*	AC164024			DM173001
PIC17C756/ 756A	64PT	PCM17XA0	DVA17PQ641	XLT64PT2 or XLT64PT5				AC174008	AC164319*				
PIC17C762	84L	PCM17XA0	DVA17XL841					AC174012	AC164318	AC164027			DM173001
PIC17C762	80PT	PCM17XA0	DVA17PQ801	XLT80PT or XLT80PT3				AC174011	AC164320				
PIC17C766	84L, 84CL	PCM17XA0	DVA17XL841					AC174012	AC164318	AC164027			DM173001
PIC17C766	80PT	PCM17XA0	DVA17PQ801	XLT80PT or XLT80PT3				AC174011	AC164320				
PIC18C242	28SP, 28JW	PCM18XA0	DVA16XP282					AC164012	AC164301	✓		SW006011	DM163022
PIC18C242	28SO	PCM18XA0	DVA16XP282	XLT28SO				AC164017	AC164302			SW006011	
PIC18C252	28SP	PCM18XA0	DVA16XP282					AC164012	AC164301	✓		SW006011	DM163022
PIC18C252	28JW	PCM18XA0	DVA16XP282	XLT28XP				AC164012	AC164301			SW006011	DM163022
PIC18C252	28SO	PCM18XA0	DVA16XP282	XLT28SO				AC164017	AC164302			SW006011	
PIC18C442	40P, 40JW	PCM18XA0	DVA16XP401					AC164012	AC164301	✓		SW006011	DM163022
PIC18C442	44L	PCM18XA0	DVA16XL441					AC164013	AC164309			SW006011	
PIC18C442	44PT	PCM18XA0	DVA16PQ441	XLT44PT or XLT44PT3				AC164020	AC164305			SW006011	
PIC18C452	40P, 40JW	PCM18XA0	DVA16XP401					AC164012	AC164301	✓		SW006011	DM163022
PIC18C452	44L	PCM18XA0	DVA16XL441					AC164013	AC164309			SW006011	
PIC18C452	44PT	PCM18XA0	DVA16PQ441	XLT44PT or XLT44PT3				AC164020	AC164305			SW006011	
PIC18C601	68L				PMF18WB1	DAF18-1	XLT68L1	AC174007	AC164308		✓	SW006011	DM163006
PIC18C601	64PT				PMF18WB1	DAF18-1	XLT64PT2 or XLT64PT5	AC174008	AC164303		✓	SW006011	

NOTE: See complete list of notes on page 80.

MPLAB® ICE 2000 and MPLAB® ICE 4000 Emulator Systems, PRO MATE® II Programmer Socket Modules, MPLAB® In-Circuit Debugger, Software Tools, Programmers and Demonstration Boards

		MPLAB® ICE 2000 System (1)			MPLAB® ICE 4000 System (2)								
Part Number	Lead Count/ Pkg Type	Processor Module	Device Adapters	Transition Socket	Processor Module	Device Adapters	Transition Socket	PRO MATE® II Socket Module (3,4)	MPLAB® PM3 Socket Module (8)	PICSTART® Plus (5)	MPLAB® ICD 2 (6)	MPLAB® CXX Compiler	Demonstration Boards or Evaluation Kits
PICmicro® Microcontroller Development Tools (continued)													
PIC18C658	68L	PCM18XB0	DVA18XL680					AC174007	AC164308	✓ (8)		SW006011	DM163007
PIC18C658	64PT	PCM18XB0	DVA18PQ640	XLT64PT2 or XLT64PT5				AC174008	AC164303			SW006011	
PIC18C801	80PT				PMF18WB1	DAF18-1	XLT80PT or XLT80PT3	AC174011	AC164304		✓	SW006011	
PIC18C801	84L				PMF18WB1	DAF18-1	XLT84L1	AC174012	AC164310		✓	SW006011	DM163006
PIC18C858	84L	PCM18XB0	DVA18XL840					AC174012	AC164310	✓ (8)		SW006011	DM163007
PIC18C858	80PT	PCM18XB0	DVA18PQ800	XLT80PT or XLT80PT3				AC174011	AC164304			SW006011	
PIC18F242	28SP	PCM18XH0 or PCM18XC1	DVA16XP282 or DVA18XP280		PMF18WC0	DAF18-2	ACICE0204	AC164012	AC164301	✓	✓	SW006011	DM163022
PIC18F242	28SO	PCM18XH0 or PCM18XC1	DVA16XP282 or DVA18XP280	XLT28SO	PMF18WC0	DAF18-2	XLT28SO	AC164017	AC164302		✓	SW006011	
PIC18F248	28SP	PCM18XD1	DVA16XP282					AC164012	AC164301	✓	✓	SW006011	DM163011
PIC18F248	28SO	PCM18XD1	DVA16XP282	XLT28SO				AC164017	AC164302		✓	SW006011	
PIC18F252	28SP	PCM18XH0 or PCM18XC1	DVA16XP282 or DVA18XP280		PMF18WC0	DAF18-2	ACICE0204	AC164012	AC164301	✓	✓	SW006011	DM163022
PIC18F252	28SO	PCM18XH0 or PCM18XC1	DVA16XP282 or DVA18XP280	XLT28SO	PMF18WC0	DAF18-2	XLT28SO	AC164017	AC164302		✓	SW006011	
PIC18F258	28SP	PCM18XD1	DVA16XP282					AC164012	AC164301	✓	✓	SW006011	DM163011
PIC18F258	28SO	PCM18XD1	DVA16XP282	XLT28SO				AC164017	AC164302		✓	SW006011	
PIC18F442	40P	PCM18XH0 or PCM18XC1	DVA16XP401 or DVA18XP400		PMF18WC0	DAF18-2	ACICE0206	AC164012	AC164301	✓	✓	SW006011	DM163022
PIC18F442	44L	PCM18XH0 or PCM18XC1	DVA16XL441		PMF18WC0	DAF18-3	XLT44L2	AC164013	AC164309		✓	SW006011	
PIC18F442	44PT	PCM18XH0 or PCM18XC1	DVA16PQ441 or DVA18PQ440	XLT44PT or XLT44PT3	PMF18WC0	DAF18-3	XLT44PT or XLT44PT3	AC164020	AC164305		✓	SW006011	
PIC18F448	40P	PCM18XD1	DVA16XP401					AC164012	AC164301	✓	✓	SW006011	DM163011
PIC18F448	44L	PCM18XD1	DVA16XL441					AC164013	AC164309		✓	SW006011	
PIC18F448	44PT	PCM18XD1	DVA16PQ441	XLT44PT or XLT44PT3				AC164020	AC164305		✓	SW006011	
PIC18F452	40P	PCM18XH0 or PCM18XC1	DVA16XP401		PMF18WC0	DAF18-2	ACICE0206	AC164012	AC164301	✓	✓	SW006011	DM163022
PIC18F452	44L	PCM18XH0 or PCM18XC1	DVA16XL441		PMF18WC0	DAF18-3	XLT44L2	AC164013	AC164309		✓	SW006011	
PIC18F452	44PT	PCM18XH0 or PCM18XC1	DVA16PQ441	XLT44PT or XLT44PT3	PMF18WC0	DAF18-3	XLT44PT or XLT44PT3	AC164020	AC164305		✓	SW006011	

NOTE: See complete list of notes on page 80.

MPLAB® ICE 2000 and MPLAB® ICE 4000 Emulator Systems, PRO MATE® II Programmer Socket Modules, MPLAB® In-Circuit Debugger, Software Tools, Programmers and Demonstration Boards

		MPLAB® ICE 2000 System (1)			MPLAB® ICE 4000 System (2)								
Part Number	Lead Count/ Pkg Type	Processor Module	Device Adapters	Transition Socket	Processor Module	Device Adapters	Transition Socket	PRO MATE® II Socket Module (3,4)	MPLAB® PM3 Socket Module (8)	PICSTART® Plus (5)	MPLAB® ICD 2 (6)	MPLAB® CXX Compiler	Demonstration Boards or Evaluation Kits
PICmicro® Microcontroller Development Tools (continued)													
PIC18F458	40P	PCM18XD1	DVA16XP401					AC164012	AC164301	✓	✓	SW006011	DM163011
PIC18F458	44L	PCM18XD1	DVA16XL441					AC164013	AC164309		✓	SW006011	
PIC18F458	44PT	PCM18XD1	DVA16PQ441	XLT44PT or XLT44PT3				AC164020	AC164305		✓	SW006011	
PIC18F1220	18P	PCM18XJ0	DVA18XP180		PMF18WD0	DAF18-2	ACICE0202	AC164010	AC164301	✓*	✓	SW006011	DM163014
PIC18F1220	18SO	PCM18XJ0	DVA18XP180	XLT18SO	PMF18WD0	DAF18-2	XLT18SO	AC164010	AC164302		✓	SW006011	
PIC18F1220	20SS	PCM18XJ0	DVA18XP180	XLT20SS	PMF18WD0	DAF18-2	XLT20SS	AC164018	AC164307		✓	SW006011	
PIC18F1220	28ML	PCM18XJ0	DVA18XP180	XLT28QFN3	PMF18WD0	DAF18-2	XLT28QFN3	AC164010 +AC164033	AC164301 +AC164031	AC164033*	✓	SW006011	
PIC18F1320	18P	PCM18XJ0	DVA18XP180		PMF18WD0	DAF18-2	ACICE0202	AC164010	AC164301	✓*	✓	SW006011	DM163014
PIC18F1320	18SO	PCM18XJ0	DVA18XP180	XLT18SO	PMF18WD0	DAF18-2	XLT18SO	AC164010	AC164302		✓	SW006011	
PIC18F1320	20SS	PCM18XJ0	DVA18XP180	XLT20SS	PMF18WD0	DAF18-2	XLT20SS	AC164018	AC164307		✓	SW006011	
PIC18F1320	28ML	PCM18XJ0	DVA18XP180	XLT28QFN3	PMF18WD0	DAF18-2	XLT28QFN3	AC164010 +AC164033	AC164301 +AC164031	AC164033*	✓	SW006011	
PIC18F2220	28SP	PCM18XH0	DVA18XP280		PMF18WC1	DAF18-2	ACICE0204	AC164012	AC164301	✓*	✓	SW006011	
PIC18F2220	28SO	PCM18XH0	DVA18XP280	XLT28SO	PMF18WC1	DAF18-2	XLT28SO	AC164017	AC164302		✓	SW006011	
PIC18F2320	28SP	PCM18XH0	DVA18XP280		PMF18WC1	DAF18-2	ACICE0204	AC164012	AC164301	✓*	✓	SW006011	
PIC18F2320	28SO	PCM18XH0	DVA18XP280	XLT28SO	PMF18WC1	DAF18-2	XLT28SO	AC164017	AC164302		✓	SW006011	
PIC18F2331	28SP	PCM18XL0	DVA18XP280		PMF18WF0*	DAF18-4	ACICE0204	AC164035	AC164301	✓*	✓	SW006011	DM183011
PIC18F2331	28SO	PCM18XL0	DVA18XP280	XLT28SO	PMF18WF0*	DAF18-4	XLT28SO	AC164036	AC164302		✓	SW006011	
PIC18F2331	28MM	PCM18XL0	DVA18XP280	XLT28QFN4*	PMF18WF0*	DAF18-4	XLT28QFN4*	AC164035 +AC164031	AC164322*	AC164031	✓	SW006011	
PIC18F2410	28SP	PCM18XN0	DVA18XP280		PCM18WH0	DAF18-4	ACICE0204	AC164035*	AC164301*	✓*	✓*	SW006011	
PIC18F2410	28SO	PCM18XN0	DVA18XP280	XLT28SO	PCM18WH0	DAF18-4	XLT28SO	AC164036*	AC164302*		✓*	SW006011	
PIC18F2410	28ML	PCM18XN0	DVA18XP280	XLT28QFN4*	PCM18WH0	DAF18-4	XLT28QFN4*	AC164035* +AC164031	AC164322*	AC164031*	✓*	SW006011	
PIC18F2420	28SP	PCM18XN0	DVA18XP280		PCM18WH0	DAF18-4	ACICE0204	AC164035*	AC164301*	✓*	✓*	SW006011	
PIC18F2420	28SO	PCM18XN0	DVA18XP280	XLT28SO	PCM18WH0	DAF18-4	XLT28SO	AC164036*	AC164302*		✓*	SW006011	
PIC18F2420	28ML	PCM18XN0	DVA18XP280	XLT28QFN4*	PCM18WH0	DAF18-4	XLT28QFN4*	AC164035* +AC164031	AC164322*	AC164031*	✓*	SW006011	
PIC18F2431	28SP	PCM18XL0	DVA18XP280		PMF18WF0*	DAF18-4	ACICE0204	AC164035	AC164301	✓*	✓	SW006011	DM183011
PIC18F2431	28SO	PCM18XL0	DVA18XP280	XLT28SO	PMF18WF0*	DAF18-4	XLT28SO	AC164036	AC164302		✓	SW006011	
PIC18F2431	28MM	PCM18XL0	DVA18XP280	XLT28QFN4*	PMF18WF0*	DAF18-4	XLT28QFN4*	AC164035 +AC164031	AC164322*	AC164031*	✓	SW006011	

NOTE: See complete list of notes on page 80.

MPLAB® ICE 2000 and MPLAB® ICE 4000 Emulator Systems, PRO MATE® II Programmer Socket Modules, MPLAB® In-Circuit Debugger, Software Tools, Programmers and Demonstration Boards

		MPLAB® ICE 2000 System (1)			MPLAB® ICE 4000 System (2)								
Part Number	Lead Count/ Pkg Type	Processor Module	Device Adapters	Transition Socket	Processor Module	Device Adapters	Transition Socket	PRO MATE® II Socket Module (3,4)	MPLAB® PM3 Socket Module (8)	PICSTART® Plus (5)	MPLAB® ICD 2 (6)	MPLAB® CXX Compiler	Demonstration Boards or Evaluation Kits
PICmicro® Microcontroller Development Tools (continued)													
PIC18F2439	28P							AC164012	AC164301*	✓*	✓	SW006011	
PIC18F2439	28SO							AC164017	AC164302*		✓	SW006011	
PIC18F2455	28SP	PCM18XR0	DVA18XP280		PMF18WL0	DAF18-4	ACICE0204	AC164012*	AC164301*	✓*	AC162063*	SW006011	DM163025
PIC18F2455	28SO	PCM18XR0	DVA18XP280	XLT28SO	PMF18WL0	DAF18-4	XLT28SO	AC164036*	AC164302*		AC162063* +XLT28SO	SW006011	DM163025
PIC18F2480	28SP	PCM18XP0*	DVA18XP280		PMF18WJ0*	DAF18-4	ACICE0204	AC164012*	AC164301*	✓*	✓*	SW006011	DM163011
PIC18F2480	28SO	PCM18XP0*	DVA18XP280	XLT28SO	PMF18WJ0*	DAF18-4	XLT28SO	AC164017*	AC164302*		✓*	SW006011	
PIC18F2480	28MM	PCM18XP0*	DVA18XP280	XLT28QFN4*	PMF18WJ0*	DAF18-4	XLT28QFN4*	AC164012* +AC164031	AC164322*	AC164031*	✓*	SW006011	
PIC18F2510	28SP	PCM18XN0	DVA18XP280		PMF18WH0	DAF18-4	ACICE0204	AC164012*	AC164301*	✓*	✓*	SW006011	DM163022
PIC18F2510	28SO	PCM18XN0	DVA18XP280	XLT28SO	PMF18WH0	DAF18-4	XLT28SO	AC164017*	AC164302*		✓*	SW006011	
PIC18F2510	28ML	PCM18XN0	DVA18XP280	XLT28QFN4*	PMF18WH0	DAF18-4	XLT28QFN4*	AC164012* +AC164031	AC164322*	AC164031*	✓*	SW006011	
PIC18F2515	28SP	PCM18XN0	DVA18XP280		PMF18WH0	DAF18-4	ACICE0204	AC164012*	AC164301*	✓	✓	SW006011	
PIC18F2515	28SO	PCM18XN0	DVA18CP280	XLT28SO	PMF18WH0	DAF18-4	XLT28SO	AC164017*	AC164302*		✓	SW006011	
PIC18F2520	28SP	PCM18XN0	DVA18XP280		PMF18WH0	DAF18-4	ACICE0204	AC164012*	AC164301*	✓	✓	SW006011	DM163022
PIC18F2520	28SO	PCM18XN0	DVA18XP280	XLT28SO	PMF18WH0	DAF18-4	XLT28SO	AC164017*	AC164302*		✓	SW006011	
PIC18F2520	28ML	PCM18XN0	DVA18XP280	XLT28QFN4*	PMF18WH0	DAF18-4	XLT28QFN4*	AC164012* +AC164031	AC164322*	AC164031	✓	SW006011	
PIC18F2525	28SP	PCM18XN0	DVA18XP280		PMF18WH0	DAF18-4	ACICE0204	AC164012*	AC164301*	✓	✓	SW006011	
PIC18F2525	28SO	PCM18XN0	DVA18XP280	XLT28SO	PMF18WH0	DAF18-4	XLT28SO	AC164017*	AC164302*		✓	SW006011	
PIC18F2539	28P							AC164012	AC164301*	✓*	✓	SW006011	
PIC18F2539	28SO							AC164017	AC164302*		✓	SW006011	
PIC18F2550	28SP	PCM18XR0	DVA18XP280		PMF18WL0	DAF18-4	ACICE0204	AC164012*	AC164301*	✓*	AC162063*	SW006011	DM163025
PIC18F2550	28SO	PCM18XR0	DVA18XP280	XLT28SO	PMF18WL0	DAF18-4	XLT28SO	AC164036*	AC164302*		AC162063* +XLT28SO	SW006011	DM163025
PIC18F2580	28SP	PCM18XP0*	DVA18XP280		PMF18WJ0*	DAF18-4	ACICE0204	AC164012*	AC164301*	✓*	✓*	SW006011	DM163011
PIC18F2580	28SO	PCM18XP0*	DVA18XP280	XLT28SO	PMF18WJ0*	DAF18-4	XLT28SO	AC164017*	AC164302*		✓*	SW006011	
PIC18F2580	28MM	PCM18XP0*	DVA18XP280	XLT28QFN4*	PMF18WJ0*	DAF18-4	XLT28QFN4*	AC164012* +AC164031	AC164322*	AC164031*	✓*	SW006011	
PIC18F2585	28SP	PCM18XP0*	DVA18XP280		PMF18WJ0*	DAF18-4	ACICE0204	AC164012	AC164301	✓	✓	SW006011	DM163011
PIC18F2585	28SO	PCM18XP0*	DVA18XP280	XLT28SO	PMF18WJ0*	DAF18-4	XLT28SO	AC164017	AC164302		✓	SW006011	

NOTE: See complete list of notes on page 80.

MPLAB® ICE 2000 and MPLAB® ICE 4000 Emulator Systems, PRO MATE® II Programmer Socket Modules, MPLAB® In-Circuit Debugger, Software Tools, Programmers and Demonstration Boards

		MPLAB® ICE 2000 System (1)			MPLAB® ICE 4000 System (2)								
Part Number	Lead Count/ Pkg Type	Processor Module	Device Adapters	Transition Socket	Processor Module	Device Adapters	Transition Socket	PRO MATE® II Socket Module (3,4)	MPLAB® PM3 Socket Module (8)	PICSTART® Plus (5)	MPLAB® ICD 2 (6)	MPLAB® CXX Compiler	Demonstration Boards or Evaluation Kits
PICmicro® Microcontroller Development Tools (continued)													
PIC18F2610	28SP	PCM18XN0	DVA18XP280		PMF18WH0	DAF18-4	ACICE0204	AC164012*	AC164301*	✓*	✓	SW006011	
PIC18F2610	28SO	PCM18XN0	DVA18XP280	XLT28SO	PMF18WH0	DAF18-4	XLT28SO	AC164017*	AC164302*		✓	SW006011	
PIC18F2620	28SP	PCM18XN0	DVA18XP280		PMF18WH0	DAF18-4	ACICE0204	AC164012*	AC164301*	✓*	✓	SW006011	
PIC18F2620	28SO	PCM18XN0	DVA18XP280	XLT28SO	PMF18WH0	DAF18-4	XLT28SO	AC164017*	AC164302*		✓	SW006011	
PIC18F2680	28SP	PCM18XP0*	DVA18XP280		PMF18WJ0*	DAF18-4	ACICE0204	AC164012	AC164301	✓*	✓	SW006011	DM163011
PIC18F2680	28SO	PCM18XP0*	DVA18XP280	XLT28SO	PMF18WJ0*	DAF18-4	XLT28SO	AC164017	AC164302		✓	SW006011	
PIC18F4220	40P	PCM18XH0	DVA18XP400		PMF18WC1	DAF18-2	ACICE0206	AC164012	AC164301	✓*	✓	SW006011	
PIC18F4220	44ML	PCM18XH0	DVA18XP400	XLT44QFN2	PMF18WC1	DAF18-2	XLT44QFN2	AC164012 +AC164034	AC164301 +AC164034	AC164034*	✓	SW006011	
PIC18F4220	44PT	PCM18XH0	DVA18PQ440	XLT44PT or XLT44PT3	PMF18WC1	DAF18-3	XLT44PT or XLT44PT3	AC164020	AC164305		✓	SW006011	
PIC18F4320	40P	PCM18XH0	DVA18XP400		PMF18WC1	DAF18-2	ACICE0206	AC164012	AC164301	✓*	✓	SW006011	
PIC18F4320	44ML	PCM18XH0	DVA18XP400	XLT44QFN2	PMF18WC1	DAF18-2	XLT44QFN2	AC164012 +AC164034	AC164301 +AC164034	AC164034*	✓	SW006011	
PIC18F4320	44PT	PCM18XH0	DVA18PQ440	XLT44PT or XLT44PT3	PMF18WC1	DAF18-3	XLT44PT or XLT44PT3	AC164020	AC164305		✓	SW006011	
PIC18F4331	40P	PCM18XL0	DVA18XP400		PMF18WF0*	DAF18-4	ACICE0206	AC164012	AC164301	✓	✓	SW006011	DM183011
PIC18F4331	44PT	PCM18XL0	DVA18PQ440	XLT44PT or XLT44PT3	PMF18WF0*	DAF18-5	XLT44PT or XLT44PT3	AC164020	AC164305		✓	SW006011	
PIC18F4331	44ML	PCM18XL0	DVA18XP400	XLT44QFN2	PMF18WF0*	DAF18-4	XLT44QFN2	AC164012 +AC164034	AC164301 +AC164034	AC164034	✓	SW006011	
PIC18F4410	40P	PCM18XN0	DVA18XP400		PCM18WH0	DAF18-4	ACICE0206	AC164012*	AC164301*	✓*	✓*	SW006011	
PIC18F4410	44PT	PCM18XN0	DVA18PQ440	XLT44PT or XLT44PT3	PCM18WH0	DAF18-5	XLT44PT or XLT44PT3	AC164020*	AC164305*		✓*	SW006011	
PIC18F4410	44ML	PCM18XN0	DVA18XP400	XLT44QFN2	PCM18WH0	DAF18-4	XLT44QFN2	AC164012* +AC164034	AC164322*	AC164034*	✓*	SW006011	
PIC18F4420	40P	PCM18XN0	DVA18XP400		PCM18WH0	DAF18-4	ACICE0206	AC164012*	AC164301*	✓*	✓*	SW006011	
PIC18F4420	44PT	PCM18XN0	DVA18PQ440	XLT44PT or XLT44PT3	PCM18WH0	DAF18-5	XLT44PT or XLT44PT3	AC164020*	AC164305*		✓*	SW006011	
PIC18F4420	44ML	PCM18XN0	DVA18XP400	XLT44QFN2	PCM18WH0	DAF18-4	XLT44QFN2	AC164012* +AC164034	AC164322*	AC164034*	✓*	SW006011	
PIC18F4431	40P	PCM18XL0	DVA18XP400		PMF18WF0*	DAF18-4	ACICE0206	AC164012	AC164301	✓	✓	SW006011	DM183011
PIC18F4431	44PT	PCM18XL0	DVA18PQ440	XLT44PT or XLT44PT3	PMF18WF0*	DAF18-5	XLT44PT or XLT44PT3	AC164020	AC164305		✓	SW006011	
PIC18F4431	44ML	PCM18XL0	DVA18XP400	XLT44QFN2	PMF18WF0*	DAF18-4	XLT44QFN2	AC164012 +AC164034	AC164301 +AC164034	AC164034	✓	SW006011	

NOTE: See complete list of notes on page 80.

MPLAB® ICE 2000 and MPLAB® ICE 4000 Emulator Systems, PRO MATE® II Programmer Socket Modules, MPLAB® In-Circuit Debugger, Software Tools, Programmers and Demonstration Boards

		MPLAB® ICE 2000 System (1)			MPLAB® ICE 4000 System (2)								
Part Number	Lead Count/ Pkg Type	Processor Module	Device Adapters	Transition Socket	Processor Module	Device Adapters	Transition Socket	PRO MATE® II Socket Module (3,4)	MPLAB® PM3 Socket Module (8)	PICSTART® Plus (5)	MPLAB® ICD 2 (6)	MPLAB® CXX Compiler	Demonstration Boards or Evaluation Kits
PICmicro® Microcontroller Development Tools (continued)													
PIC18F4439	40P							AC164012	AC164301*	✓*	✓	SW006011	
PIC18F4439	44ML							AC164012 +AC164034	AC164301* +AC164034	AC164034*	✓	SW006011	
PIC18F4439	44PT							AC164020	AC164305*		✓	SW006011	
PIC18F4455	40P	PCM18XR0	DVA18XP400		PMF18WL0	DAF18-4	ACICE0206	AC164012*	AC164301*	✓*	AC162063*	SW006011	DM163025
PIC18F4455	44ML	PCM18XR0	DVA18XP400	XLT44QFN2	PMF18WL0	DAF18-4	XLT44QFN2	AC164012* +AC164034	AC164322*	AC164034*	AC162063* +XLT44QFN2	SW006011	DM163025
PIC18F4455	44PT	PCM18XR0	DVA18PQ440	XLT44PT or XLT44PT3	PMF18WL0	DAF18-5	XLT44PT or XLT44PT3	AC164020*	AC164305*		AC162063* +XLT44PT or XLT44PT3	SW006011	DM163025
PIC18F4480	40P	PCM18XP0*	DVA18XP400		PMF18WJ0*	DAF18-4	ACICE0206	AC164012*	AC164301*	✓*	✓*	SW006011	DM163011
PIC18F4480	44PT	PCM18XP0*	DVA18PQ440	XLT44PT or XLT44PT3	PMF18WJ0*	DAF18-5	XLT44PT or XLT44PT3	AC164020*	AC164305*		✓*	SW006011	
PIC18F4480	44ML	PCM18XP0*	DVA18XP400	XLT44QFN2	PMF18WJ0*	DAF18-4	XLT44QFN2	AC164012* +AC164034	AC164322*	AC164034*	✓*	SW006011	
PIC18F4510	40P	PCM18XN0	DVA18XP400		PMF18WH0	DAF18-4	ACICE0206	AC164012*	AC164301*	✓*	✓*	SW006011	DM163022
PIC18F4510	44PT	PCM18XN0	DVA18PQ440	XLT44PT or XLT44PT3	PMF18WH0	DAF18-5	XLT44PT or XLT44PT3	AC164020*	AC164305*		✓*	SW006011	
PIC18F4510	44ML	PCM18XN0	DVA18XP400	XLT44QFN2	PMF18WH0	DAF18-4	XLT44QFN2	AC164012* +AC164034	AC164301* +AC164034	AC164034*	✓*	SW006011	
PIC18F4515	40P	PCM18XN0	DVA18XP400		PMF18WH0	DAF18-4	ACICE0206	AC164012	AC164301*	✓	✓	SW006011	
PIC18F4515	44PT	PCM18XN0	DVA18PQ440	XLT44PT or XLT44PT3	PMF18WH0	DAF18-5	XLT44PT or XLT44PT3	AC164020	AC164305*		✓	SW006011	
PIC18F4515	44ML	PCM18XN0	DVA18XP400	XLT44QFN2	PMF18WH0	DAF18-4	XLT44QFN2	AC164012 +AC164034	AC164301* +AC164034	AC164034	✓	SW006011	
PIC18F4520	40P	PCM18XN0	DVA18XP400		PMF18WH0	DAF18-4	ACICE0206	AC164012	AC164301*	✓	✓*	SW006011	DM163022
PIC18F4520	44PT	PCM18XN0	DVA18PQ440	XLT44PT or XLT44PT3	PMF18WH0	DAF18-5	XLT44PT or XLT44PT3	AC164020	AC164305*		✓*	SW006011	
PIC18F4520	44ML	PCM18XN0	DVA18XP400	XLT44QFN2	PMF18WH0	DAF18-4	XLT44QFN2	AC164012 +AC164034	AC164301* +AC164034	AC164034	✓*	SW006011	
PIC18F4525	40P	PCM18XN0	DVA18XP400		PMF18WH0	DAF18-4	ACICE0206	AC164012*	AC164301*	✓	✓	SW006011	
PIC18F4525	44PT	PCM18XN0	DVA18PQ440	XLT44PT or XLT44PT3	PMF18WH0	DAF18-5	XLT44PT or XLT44PT3	AC164020*	AC164305*		✓	SW006011	
PIC18F4525	44ML	PCM18XN0	DVA18XP400	XLT44QFN2	PMF18WH0	DAF18-4	XLT44QFN2	AC164012* +AC164034	AC164301* +AC164034	AC164034	✓	SW006011	

NOTE: See complete list of notes on page 80.

MPLAB® ICE 2000 and MPLAB® ICE 4000 Emulator Systems, PRO MATE® II Programmer Socket Modules, MPLAB® In-Circuit Debugger, Software Tools, Programmers and Demonstration Boards

		MPLAB® ICE 2000 System (1)			MPLAB® ICE 4000 System (2)								
Part Number	Lead Count/ Pkg Type	Processor Module	Device Adapters	Transition Socket	Processor Module	Device Adapters	Transition Socket	PRO MATE® II Socket Module (3,4)	MPLAB® PM3 Socket Module (8)	PICSTART® Plus (5)	MPLAB® ICD 2 (6)	MPLAB® CXX Compiler	Demonstration Boards or Evaluation Kits
PICmicro® Microcontroller Development Tools (continued)													
PIC18F4539	40P							AC164012	AC164301*	✓*	✓	SW006011	
PIC18F4539	44ML							AC164012 +AC164034	AC164301* +AC164034	AC164034*	✓	SW006011	
PIC18F4539	44PT							AC164020	AC164305*		✓	SW006011	
PIC18F4550	40P	PCM18XR0	DVA18XP400		PMF18WL0	DAF18-4	ACICE0206	AC164012*	AC164301*	✓*	AC162063*	SW006011	DM163025
PIC18F4550	44ML	PCM18XR0	DVA18XP400	XLT44QFN2	PMF18WL0	DAF18-4	XLT44QFN2	AC164012* +AC164034	AC164322*	AC164034*	AC162063* +XLT44QFN2	SW006011	DM163025
PIC18F4550	44PT	PCM18XR0	DVA18PQ440	XLT44PT or XLT44PT3	PMF18WL0	DAF18-5	XLT44PT or XLT44PT3	AC164020*	AC164305*		AC162063* +XLT44PT or XLT44PT3	SW006011	DM163025
PIC18F4580	40P	PCM18XP0*	DVA18XP400		PMF18WJ0*	DAF18-4	ACICE0206	AC164012*	AC164301*	✓*	✓*	SW006011	
PIC18F4580	44PT	PCM18XP0*	DVA18PQ440	XLT44PT or XLT44PT3	PMF18WJ0*	DAF18-5	XLT44PT or XLT44PT3	AC164020*	AC164305*		✓*	SW006011	
PIC18F4580	44ML	PCM18XP0*	DVA18XP400	XLT44QFN2	PMF18WJ0*	DAF18-4	XLT44QFN2	AC164012* +AC164034	AC164322*	AC164034*	✓*	SW006011	
PIC18F4585	40P	PCM18XP0*	DVA18XP400		PMF18WJ0*	DAF18-4	ACICE0206	AC164012	AC164301	✓	✓	SW006011	DM163011
PIC18F4585	44PT	PCM18XP0*	DVA18PQ440	XLT44PT or XLT44PT3	PMF18WJ0*	DAF18-5	XLT44PT or XLT44PT3	AC164020	AC164305		✓	SW006011	
PIC18F4585	44ML	PCM18XP0*	DVA18XP400	XLT44QFN2	PMF18WJ0*	DAF18-4	XLT44QFN2	AC164012 +AC164034	AC164301 +AC164034	AC164034	✓	SW006011	
PIC18F4610	40P	PCM18XN0	DVA18XP400		PMF18WH0	DAF18-4	ACICE0206	AC164012*	AC164301*	✓*	✓	SW006011	
PIC18F4610	44PT	PCM18XN0	DVA18PQ440	XLT44PT or XLT44PT3	PMF18WH0	DAF18-5	XLT44PT or XLT44PT3	AC164020*	AC164305*		✓	SW006011	
PIC18F4610	44ML	PCM18XN0	DVA18XP400	XLT44QFN2	PMF18WH0	DAF18-4	XLT44QFN2	AC164012* +AC164034	AC164301* +AC164034	AC164034*	✓	SW006011	
PIC18F4620	40P	PCM18XN0	DVA18XP400		PMF18WH0	DAF18-4	ACICE0206	AC164012	AC164301*	✓	✓	SW006011	DM163026, DM163027-2
PIC18F4620	44PT	PCM18XN0	DVA18PQ440	XLT44PT or XLT44PT3	PMF18WH0	DAF18-5	XLT44PT or XLT44PT3	AC164020	AC164305*		✓	SW006011	
PIC18F4620	44ML	PCM18XN0	DVA18XP400	XLT44QFN2	PMF18WH0	DAF18-4	XLT44QFN2	AC164012 +AC164034	AC164301* +AC164034	AC164034	✓	SW006011	
PIC18F4680	40P	PCM18XP0*	DVA18XP400		PMF18WJ0*	DAF18-4	ACICE0206	AC164012	AC164301	✓	✓	SW006011	DM163011
PIC18F4680	44PT	PCM18XP0*	DVA18PQ440	XLT44PT or XLT44PT3	PMF18WJ0*	DAF18-5	XLT44PT or XLT44PT3	AC164020	AC164305		✓	SW006011	
PIC18F4680	44ML	PCM18XP0*	DVA18XP400	XLT44QFN2	PMF18WJ0*	DAF18-4	XLT44QFN2	AC164012 +AC164034	AC164301 +AC164034	AC164034	✓	SW006011	
PIC18F6310	64PT	PCM18XQ0	DVA1003	XLT64PT2 or XLT64PT5	PMF18WK0	DAF18-6	XLT64PT2 or XLT64PT5	TBD	AC164303*		✓*	SW006011	

NOTE: See complete list of notes on page 80.

MPLAB® ICE 2000 and MPLAB® ICE 4000 Emulator Systems, PRO MATE® II Programmer Socket Modules, MPLAB® In-Circuit Debugger, Software Tools, Programmers and Demonstration Boards

		MPLAB® ICE 2000 System (1)			MPLAB® ICE 4000 System (2)								
Part Number	Lead Count/ Pkg Type	Processor Module	Device Adapters	Transition Socket	Processor Module	Device Adapters	Transition Socket	PRO MATE® II Socket Module (3,4)	MPLAB® PM3 Socket Module (8)	PICSTART® Plus (5)	MPLAB® ICD 2 (6)	MPLAB® CXX Compiler	Demonstration Boards or Evaluation Kits
PICmicro® Microcontroller Development Tools (continued)													
PIC18F6390	64PT	PCM18XQ0	DVA1003	XLT64PT2 or XLT64PT5	PMF18WK0	DAF18-6	XLT64PT2 or XLT64PT5	TBD	AC164303*		✓*	SW006011	DM163028
PIC18F6410	64PT	PCM18XQ0	DVA1003	XLT64PT2 or XLT64PT5	PMF18WK0	DAF18-6	XLT64PT2 or XLT64PT5	AC174008	AC164303		✓	SW006011	
PIC18F6490	64PT	PCM18XQ0	DVA1003	XLT64PT2 or XLT64PT5	PMF18WK0	DAF18-6	XLT64PT2 or XLT64PT5	AC174008	AC164303		✓	SW006011	DM163028
PIC18F6520	64PT	PCM18XE1	DVA18PQ640	XLT64PT2 or XLT64PT5	PMF18WA1 or PMF18WA2	DAF18-1 or DAF18-6	XLT64PT2 or XLT64PT5	AC174008	AC164303	✓ (7)*	✓	SW006011	DM183020
PIC18F6525	64PT	PCM18XK0	DVA18PQ802	XLT64PT2 or XLT64PT5	PMF18WE0	DAF18-1	XLT64PT2 or XLT64PT5	AC174008	AC164303	✓ (7)*	✓	SW006011	
PIC18F6585	68L	PCM18XK0	DVA18PQ802	XLT68L1	PMF18WE0	DAF18-1	XLT68L1	AC174007	AC164308	✓ (7)*	✓	SW006011	
PIC18F6585	64PT	PCM18XK0	DVA18PQ802	XLT64PT2 or XLT64PT5	PMF18WE0	DAF18-1	XLT64PT2 or XLT64PT5	AC174008	AC164303	✓ (7)*	✓	SW006011	DM163015
PIC18F6620	64PT	PCM18XE1	DVA18PQ640	XLT64PT2 or XLT64PT5	PMF18WA1 or PMF18WA2	DAF18-1 or DAF18-6	XLT64PT2 or XLT64PT5	AC174008	AC164303	✓ (7)*	✓	SW006011	DM183020
PIC18F6621	64PT	PCM18XK0	DVA18PQ802	XLT64PT2 or XLT64PT5	PMF18WE0	DAF18-1	XLT64PT2 or XLT64PT5	AC174008	AC164303	✓ (7)*	✓	SW006011	
PIC18F6627	64PT	PCM18XS0*	DVA1003	XLT64PT2 or XLT64PT5	PMF18WS0	DAF18-6	XLT64PT2 or XLT64PT5	AC174008*	AC164303*	✓ (7)*	✓*	SW006011	DM183022*
PIC18F6680	68L	PCM18XK0	DVA18PQ802	XLT68L1	PMF18WE0	DAF18-1	XLT68L1	AC174007	AC164308	✓ (7)*	✓	SW006011	
PIC18F6680	64PT	PCM18XK0	DVA18PQ802	XLT64PT2 or XLT64PT5	PMF18WE0	DAF18-1	XLT64PT2 or XLT64PT5	AC174008	AC164303	✓ (7)*	✓	SW006011	DM163015
PIC18F6720	64PT	PCM18XE1	DVA18PQ640	XLT64PT2 or XLT64PT5	PMF18WA1 or PMF18WA2	DAF18-1 or DAF18-6	XLT64PT2 or XLT64PT5	AC174008	AC164303	✓ (7)*	✓	SW006011	DM183020
PIC18F6722	64PT	PCM18XS0*	DVA1003	XLT64PT2 or XLT64PT5	PMF18WS0	DAF18-6	XLT64PT2 or XLT64PT5	AC174008*	AC164303*	✓ (7)*	✓*	SW006011	DM183022*
PIC18F8310	80PT	PCM18XQ0	DVA1003	XLT80PT or XLT80PT3	PMF18WK0	DAF18-6	XLT80PT or XLT80PT3	TBD	AC164304*		✓*	SW006011	
PIC18F8390	80PT	PCM18XQ0	DVA1003	XLT80PT or XLT80PT3	PMF18WK0	DAF18-6	XLT80PT or XLT80PT3	TBD	AC164304*		✓*	SW006011	DM163028
PIC18F8410	80PT	PCM18XQ0	DVA1003	XLT80PT or XLT80PT3	PMF18WK0	DAF18-6	XLT80PT or XLT80PT3	AC174011*	AC164304		✓*	SW006011	
PIC18F8490	80PT	PCM18XQ0	DVA1003	XLT80PT or XLT80PT3	PMF18WK0	DAF18-6	XLT80PT or XLT80PT3	AC174011	AC164304		✓	SW006011	DM163028
PIC18F8520	80PT	PCM18XE1	DVA18PQ800	XLT80PT or XLT80PT3	PMF18WA1 or PMF18WA2	DAF18-1 or DAF18-6	XLT80PT or XLT80PT3	AC174011	AC164304	✓ (7)*	✓	SW006011	DM183020
PIC18F8525	80PT	PCM18XK0	DVA18PQ802	XLT80PT or XLT80PT3	PMF18WE0	DAF18-1	XLT80PT or XLT80PT3	AC174011	AC164304	✓ (7)*	✓	SW006011	

NOTE: See complete list of notes on page 80.

MPLAB® ICE 2000 and MPLAB® ICE 4000 Emulator Systems, PRO MATE® II Programmer Socket Modules, MPLAB® In-Circuit Debugger, Software Tools, Programmers and Demonstration Boards

		MPLAB® ICE 2000 System (1)			MPLAB® ICE 4000 System (2)								
Part Number	Lead Count/ Pkg Type	Processor Module	Device Adapters	Transition Socket	Processor Module	Device Adapters	Transition Socket	PRO MATE® II Socket Module (3,4)	MPLAB® PM3 Socket Module (8)	PICSTART® Plus (5)	MPLAB® ICD 2 (6)	MPLAB® CXX Compiler	Demonstration Boards or Evaluation Kits
PICmicro® Microcontroller Development Tools (continued)													
PIC18F8585	80PT	PCM18XK0	DVA18PQ802	XLT80PT or XLT80PT3	PMF18WE0	DAF18-1	XLT80PT or XLT80PT3	AC174011	AC164304	✓ (7)*	✓	SW006011	DM163015
PIC18F8620	80PT	PCM18XE1	DVA18PQ800	XLT80PT or XLT80PT3	PMF18WA1 or PMF18WA2	DAF18-1 or DAF18-6	XLT80PT or XLT80PT3	AC174011	AC164304	✓ (7)	✓	SW006011	DM183020
PIC18F8621	80PT	PCM18XK0	DVA18PQ802	XLT80PT or XLT80PT3	PMF18WE0	DAF18-1	XLT80PT or XLT80PT3	AC174011	AC164304	✓ (7)*	✓	SW006011	
PIC18F8627	80PT	PCM18XS0*	DVA1003	XLT80PT or XLT80PT3	PMF18WM0*	DAF18-6	XLT80PT or XLT80PT3	AC174011*	AC164304*	✓ (7)*	✓*	SW006011	DM183022*
PIC18F8680	80PT	PCM18XK0	DVA18PQ802	XLT80PT or XLT80PT3	PMF18WE0	DAF18-1	XLT80PT or XLT80PT3	AC174011	AC164304	✓ (7)*	✓	SW006011	DM163015
PIC18F8720	80PT	PCM18XE1	DVA18PQ800	XLT80PT or XLT80PT3	PMF18WA1 or PMF18WA2	DAF18-1 or DAF18-6	XLT80PT or XLT80PT3	AC174011	AC164304	✓ (7)	✓	SW006011	DM183020
PIC18F8722	80PT	PCM18XS0*	DVA1003	XLT80PT or XLT80PT3	PMF18WM0*	DAF18-6	XLT80PT or XLT80PT3	AC174011*	AC164304*	✓ (7)*	✓*	SW006011	DM183022*
rfPIC® Microcontroller Development Tools													
rfPIC12C509AF	20JW	PCM16XA0	DVA12XP080					AC124001	AC164301	✓			
rfPIC12C509AF	20SS	PCM16XA0	DVA12XP080	XLT20SS				AC124002	AC164307				
rfPIC12C509AG	18JW	PCM16XA0	DVA12XP080					AC124001	AC164301	✓			
rfPIC12C509AG	18SO	PCM16XA0	DVA12XP080	XLT18SO				AC124002	AC164302	✓ (7)			
rfPIC12F675F	20SS	PCM12XB0	DVA12XP081	XLT20SS				AC124002	AC164307	✓ (7)*			DV164102 AC164101 AC164103
rfPIC12F675H	20SS	PCM12XB0	DVA12XP081	XLT20SS				AC124002	AC164307	✓ (7)*			
rfPIC12F675K	20SS	PCM12XB0	DVA12XP081	XLT20SS				AC124002	AC164307	✓ (7)*			DV164102 AC164102 AC164104
rfRXD0420	32LQ												DV164102
rfRXD0920	32LQ												
dsPIC® DSC Development Tools													
dsPIC30F2010	28SO				PMF30XA1	DAF30-4	XLT28SO	AC30F004	AC164302		✓	SW006012	DM300017
dsPIC30F2010	28SP				PMF30XA1	DAF30-4	ACICE0204	AC30F004	AC164301		✓	SW006012	DM300017
dsPIC30F2010	28MM				PMF30XA1	DAF30-4	XLT28QFN4*		AC164322*		✓	SW006012	
dsPIC30F2011	18SO				PMF30XA1*	DAF30-4	XLT18SO	AC30F005*	AC164302*		✓*	SW006012	DM300017
dsPIC30F2011	18P				PMF30XA1*	DAF30-4	ACICE0202	AC30F005*	AC164301*		✓*	SW006012	DM300017
dsPIC30F2012	28SO				PMF30XA1*	DAF30-4	XLT28SO	AC30F004*	AC164302*		✓*	SW006012	DM300017
dsPIC30F2012	28SP				PMF30XA1*	DAF30-4	ACICE0204	AC30F004*	AC164301*		✓*	SW006012	DM300017

NOTE: See complete list of notes on page 80.

MPLAB® ICE 2000 and MPLAB® ICE 4000 Emulator Systems, PRO MATE® II Programmer Socket Modules, MPLAB® In-Circuit Debugger, Software Tools, Programmers and Demonstration Boards

		MPLAB® ICE 2000 System (1)			MPLAB® ICE 4000 System (2)								
Part Number	Lead Count/ Pkg Type	Processor Module	Device Adapters	Transition Socket	Processor Module	Device Adapters	Transition Socket	PRO MATE® II Socket Module (3,4)	MPLAB® PM3 Socket Module (8)	PICSTART® Plus (5)	MPLAB® ICD 2 (6)	MPLAB® CXX Compiler	Demonstration Boards or Evaluation Kits
dsPIC® DSC Development Tools (continued)													
dsPIC30F3010	28SO				PMF30XA1	DAF30-4	XLT28SO	AC30F004*	AC164302		✓*	SW006012	DM300017
dsPIC30F3010	28SP				PMF30XA1	DAF30-4	ACICE0204	AC30F004*	AC164301		✓*	SW006012	DM300017
dsPIC30F3011	40P				PMF30XA1	DAF30-4	ACICE0206	AC30F003*	AC164301		✓*	SW006012	
dsPIC30F3011	44PT				PMF30XA1	DAF30-3	XLT44PT or XLT44PT3	AC30F006*	AC164305		✓*	SW006012	
dsPIC30F3011	44ML				PMF30XA1	DAF30-4	XLT44QFN2		AC164322*		✓*	SW006012	
dsPIC30F3012	18SO				PMF30XA1	DAF30-4	XLT18SO	AC30F005*	AC164302*		✓*	SW006012	
dsPIC30F3012	18P				PMF30XA1	DAF30-4	ACICE0202	AC30F005*	AC164301*		✓*	SW006012	
dsPIC30F3013	28SO				PMF30XA1	DAF30-4	XLT28SO	AC30F004*	AC164302*		✓*	SW006012	
dsPIC30F3013	28SP				PMF30XA1	DAF30-4	ACICE0204	AC30F004*	AC164301*		✓*	SW006012	
dsPIC30F3013	44ML				PMF30XA1	DAF30-4	XLT44QFN3*		AC164322*		✓*	SW006012	
dsPIC30F3014	40P				PMF30XA1	DAF30-4	ACICE0206	AC30F003*	AC164301*		✓	SW006012	
dsPIC30F3014	44PT				PMF30XA1	DAF30-3	XLT44PT or XLT44PT3	AC30F006*	AC164305*		✓	SW006012	
dsPIC30F3014	44ML				PMF30XA1	DAF30-4	XLT44QFN2		AC164322*		✓	SW006012	
dsPIC30F4011	40P				PMF30XA1	DAF30-4	ACICE0206	AC30F003	AC164301		✓	SW006012	
dsPIC30F4011	44PT				PMF30XA1	DAF30-3	XLT44PT or XLT44PT3	AC30F006	AC164305		✓	SW006012	
dsPIC30F4011	44ML				PMF30XA1	DAF30-4	XLT44QFN2		AC164322*		✓	SW006012	
dsPIC30F4012	28SO				PMF30XA1	DAF30-4	XLT28SO	AC30F004	AC164302		✓	SW006012	DM300017
dsPIC30F4012	28SP				PMF30XA1	DAF30-4	ACICE0204	AC30F004	AC164301		✓	SW006012	DM300017
dsPIC30F4013	40P				PMF30XA1	DAF30-4	ACICE0206	AC30F003*	AC164301*		✓	SW006012	
dsPIC30F4013	44PT				PMF30XA1	DAF30-3	XLT44PT or XLT44PT3	AC30F006*	AC164305*		✓	SW006012	
dsPIC30F4013	44ML				PMF30XA1	DAF30-4	XLT44QFN2		AC164322*		✓	SW006012	
dsPIC30F5011	64PT				PMF30XA1	DAF30-2	XLT64PT2 or XLT64PT5	AC30F008*	AC164319*		✓	SW006012	DM300016
dsPIC30F5013	80PT				PMF30XA1	DAF30-2	XLT80PT or XLT80PT3	AC30F007*	AC164320*		✓	SW006012	DM300014, DM300004-1, DM300004-2
dsPIC30F5015	64PT				PMF30XA1*	DAF30-2	XLT64PT2 or XLT64PT5	AC30F008*	AC164319*		✓*	SW006012*	
dsPIC30F5016	80PT				PMF30XA1*	DAF30-2	XLT80PT or XLT80PT3		AC164320*		✓*	SW006012*	

NOTE: See complete list of notes on page 80.

MPLAB® ICE 2000 and MPLAB® ICE 4000 Emulator Systems, PRO MATE® II Programmer Socket Modules, MPLAB® In-Circuit Debugger, Software Tools, Programmers and Demonstration Boards

		MPLAB® ICE 2000 System (1)			MPLAB® ICE 4000 System (2)								
Part Number	Lead Count/ Pkg Type	Processor Module	Device Adapters	Transition Socket	Processor Module	Device Adapters	Transition Socket	PRO MATE® II Socket Module (3,4)	MPLAB® PM3 Socket Module (8)	PICSTART® Plus (5)	MPLAB® ICD 2 (6)	MPLAB® CXX Compiler	Demonstration Boards or Evaluation Kits
dsPIC® DSC Development Tools (continued)													
dsPIC30F6010	80PF				PMF30XA1	DAF30-2	XLT80PT2	AC30F001	AC164314		✓	SW006012	DM300020
dsPIC30F6010A	80PF				PMF30XA1*	DAF30-2	XLT80PT2		AC164314*		✓*	SW006012*	
dsPIC30F6010A	80PT				PMF30XA1*	DAF30-2	XLT80PT or XLT80PT3	AC30F007*	AC164304*		✓*	SW006012	DM300020
dsPIC30F6011	64PF				PMF30XA1	DAF30-2	XLT64PT2 or XLT64PT5	AC30F002	AC164313		✓	SW006012	DM300016
dsPIC30F6011A	64PF				PMF30XA1*	DAF30-2	TBD	AC30F008*	AC164313*		✓*	SW006012	
dsPIC30F6011A	64PT				PMF30XA1*	DAF30-2	XLT64PT2 or XLT64PT5	AC30F008*	AC164319*		✓*	SW006012	DM300016
dsPIC30F6012	64PF				PMF30XA1	DAF30-2	XLT64PT3 or XLT64PT4	AC30F002*	AC164313		✓	SW006012	DM300016
dsPIC30F6012A	64PF				PMF30XA1*	DAF30-2	TBD	AC30F002*	AC164313*		✓*	SW006012	
dsPIC30F6012A	64PT				PMF30XA1*	DAF30-2	XLT64PT2 or XLT64PT5	AC30F008*	AC164319*		✓*	SW006012	DM300016
dsPIC30F6013	80PF				PMF30XA1	DAF30-2	XLT80PT2	AC30F001	AC164314		✓	SW006012	DM300014
dsPIC30F6013A	80PF				PMF30XA1*	DAF30-2	XLT80PT2	AC30F001*	AC164314*		✓*	SW006012	
dsPIC30F6013A	80PT				PMF30XA1*	DAF30-2	XLT80PT or XLT80PT3	AC30F007*	AC164320*		✓*	SW006012	DM300014
dsPIC30F6014	80PF				PMF30XA1	DAF30-2	XLT80PT2	AC30F001	AC164314		✓	SW006012	DM300014, DM300004-1, DM300004-2
dsPIC30F6014A	80PF				PMF30XA1*	DAF30-2	XLT80PT2	AC30F001*	AC164314*		✓*	SW006012	
dsPIC30F6014A	80PT				PMF30XA1*	DAF30-2	XLT80PT or XLT80PT3	AC30F007*	AC164304*		✓*	SW006012	DM300014, DM300004-1, DM300004-2
dsPIC30F6015	64PT				PMF30XA1*	DAF30-2	XLT64PT2 or XLT64PT5		AC164319*		✓*	SW006012*	

NOTE: See complete list of notes on page 80.

MPLAB® ICE 2000 and MPLAB® ICE 4000 Emulator Systems, PRO MATE® II Programmer Socket Modules, MPLAB® In-Circuit Debugger, Software Tools, Programmers and Demonstration Boards - NOTES

- NOTES**
- 1: MPLAB® ICE 2000 pod available separately. (ICE2000)
 - 2: MPLAB® ICE 4000 pod available separately. (ICE4000)
 - 3: PRO MATE® II Programmer unit (no longer available). (DV007003)
 - 4: Optional In-Circuit Serial Programming™ (ICSP™) Socket for PRO MATE® II available separately. (AC004004)
 - 5: PICSTART® Plus (DV003001)
 - 6: MPLAB® ICD 2 In-Circuit Debugger. Configurations are:
 (DV164005) ICD 2 module, USB cable and ICD cable.
 (DV164006) ICD 2 module, USB cable, ICD cable, serial cable, PICDEM™ 2 Plus and power supply.
 (DV164007) ICD 2 module, USB cable, ICD cable, serial cable and power supply;
 (DV164030) ICD 2 module, USB cable, ICD cable, serial cable and dsPICDEM™ Starter Demo Board;
 (AC162049) ICD 2 Universal Programming Module;
 (AC162051) ICD or ICD 2 28/40 PDIP Header Interface Board.
 - 7: Custom adapter required; not available from Microchip. See “Readme” for PICSTART® Plus.
 - 8: MPLAB® PM3 Programmer Unit available separately. (DV007004). ICSP™ function is built-in with MPLAB® PM3 Programmer.
 (AC164350) MPLAB® PM3 Adapter for PRO MATE® II Socket modules.

* New product or future support. Contact Microchip web site at www.microchip.com for availability.

✓ Supported with basic configuration. If a part number is listed in the column, that part is required and available separately.

Demonstration Boards and Evaluation Kits	
Part Number	Description
PICmicro® Demonstration Kits	
DM143001	PICDEM™ 14A Demo Board for PIC14C000
DM163001	PICDEM™ 1 Demo Board for PIC16C5X, 55X, 62X, CE62X, 71, 710, 711, 715, 770, 771, 83, 84, and PIC17C42, 43, 44
DM163003	PICDEM™ 3 Demo Board for PIC16C923, 924
DM163006	PICDEM™ 18R Demo Board for PIC18C601/801
DM163014	PICDEM™ 4 Demo Board for PIC12F629, 675, PIC16F630, 676, 684, 627A, 628A, 648A, 818, 819, 87, 88, PIC18F1220, 1320
DM163022	PICDEM™ 2 Plus Demo Board for PIC16C62, 63, 64, 65, 66, 67, 72, 73, 74, 76, 77, 87X, 773, 774 and PIC18CXX2, 642, 662, and PIC18FXXX
DM163026	Low-Power Solutions Demo Board
DM163028	PICDEM™ LCD Demo Board (uses 64L/80L PIC18FXX90 and 28L/40L PIC16F91X family)
DV164101	PICkit™ 1 8/14P Flash Development Kit for PIC12F629, 675 and PIC16F630, 676
DV164102	rfPIC® Development Kit 1
AC164101	rfPIC® Transmitter Module (433.92 MHz)
AC164102	rfPIC® Transmitter Module (315 MHz)
AC164103	rfRXD Receiver Module (433.92 MHz)
AC164104	rfRXD Receiver Module (315 MHz)
AC164120	Signal Analysis PICtail™ Daughter Board
AC163020	PIC10F2XX Programmer Adapter
AC163021	6L SOT-23 to 8P DIP Adapter Kit
DM173001	PICDEM™ 17 Demo Board for PIC17CXX
DM183011	PICDEM™ MC Development Board (uses 28L/40L PIC18FXX31 family)
DM183020	PIC18FXX20 64/80L TQFP Demo Board for PIC18F6620, 6720, 8620, 8720, 6520, 8520
DM183022*	PICDEM™ HPC Explorer Board
Connectivity Demonstration Kits	
DM163004-LT	PICDEM.net™ TCP/IP Demo Board (with no text book)
DM163005	PICDEM™ LIN Demo Board for PIC16C432/433 LIN bus
DM163007	PICDEM™ CAN-LIN 1 Demo Board (uses 68L/84L PIC18CXX8 family)
DM163010	PICDEM™ USB Demo Board for PIC16C7X5
DM163011	PICDEM™ CAN-LIN 2 Demo Board (uses 28L/40L PIC18FXX8 and PIC18FXX8X family)
DM163015	PICDEM™ CAN-LIN 3 Demo Board (uses 64L/80L PIC18FXX8X family)
DM163025	PICDEM™ FS USB Demo Board
DM163027-2	PICDEM™ Z 2.4 GHz Demonstration Kit
AC163027-1	PICDEM™ Z Motherboard
AC163027-2	PICDEM™ Z 2.4 GHz Daughter Card

* Contact Microchip web site at www.microchip.com for availability.

Demonstration Boards and Evaluation Kits	
Part Number	Description
Mixed Signal Control Demonstration Kits	
AC163001	PICDEM™ MSC 1 Voltage Boost Demo Board; requires DM163012
AC163002	PICDEM™ MSC 1 High Power IR Demo Board; requires DM163012
AC163003	PICDEM™ MSC 1 Delta Sigma Demo Board; requires DM163012
AC163004	PICDEM™ MSC 1 Flow Rate Sensor Demo Board; requires DM163012
DM163012	PICDEM™ MSC 1 Mixed Signal Controller Demo Board for PIC16C781/782
dsPIC® 16-bit DSC Demonstration Kits	
DM300004-1	dsPICDEM.net™ 1 FCC/JATE PSTN Support, Ethernet NIC Demo Board
DM300004-2	dsPICDEM.net™ 2 CTR-21 PSTN Support, Ethernet NIC Demo Board
DM300014	dsPICDEM™ 1.1 General Purpose Demo Board
DM300016	dsPICDEM™ Starter Demo Board
DM300017	dsPICDEM™ 28-Pin Starter Demo Board
DM300020	dsPICDEM™ MC1 Motor Control Development Board
DM300021	dsPICDEM™ MC1H 3-Phase High Voltage Power Module
DM300022	dsPICDEM™ MC1L 3-Phase Low Voltage Power Module
dsPIC® 16-bit DSC Software Tools	
SW300001	Digital Filter Design
SW300002	dsPIC® V.22/V.22bis Soft Modem Library (free download: www.microchip.com)
SW300003-EVAL	dsPIC® V.32 Soft Modem Library (Eval Copy)
SW300003, 04, 05	dsPIC® V.32 Soft Modem Library (5K, 25K, 100K licenses, respectively)
SW300006*	dsPIC® V.22/V.22bis Soft Modem Library by Vocal Technology
SW300010-EVAL	dsPIC® Speech Recognition (Eval Copy)
SW300010, 11, 12*	dsPIC® Speech Recognition (5K, 25K, 100K licenses, respectively)
SW300020	dsPIC30 Math Library: Double-Precision Floating Point Routines
SW300021	dsPIC30 Peripheral Library: Peripheral Initialization and Control Routines
SW300022	dsPIC30 DSP Library: Data Signal Processing Library Suite (FFT, Filters)
SW300023	dsPICworks™ Visual Algorithm Analyzer: Data Analyzer and Converter Tool
SW300030	dsPIC® CMX Scheduler: Multi-tasking, Preemptive Scheduler for dsPIC30F
SW300060-5K, 25K, 100K	Acoustic Echo Cancellation Library
SW300031	CMX-RTX for dsPIC® DSC: Fully Preemptive RTOS
SW300032	CMX-Tiny+ for dsPIC® DSC: Preemptive RTOS
SW300040-EVAL, 5K, 25K, 100K	Noise Suppression Library (Eval, 5K, 25K, 100K licenses, respectively)
SW300050-EVAL, 5K, 25K, 100K	dsPIC® Symmetric Embedded Encryption Library (Eval, 5K, 25K, 100K licenses, respectively)
SW300055-EVAL, 5K, 25K, 100K	dsPIC® Asymmetric Embedded Encryption Library (Eval, 5K, 25K, 100K licenses, respectively)
SW300060-EVAL, 5K, 25K, 100K	Acoustic Echo Cancellation Library (Eval, 5K, 25K, 100K licenses, respectively)

* Contact Microchip web site at www.microchip.com for availability.

PowerSmart® Systems

Model Name/ Part Number	Description
PS042	PS401 PowerCal™ Board
PS051	PowerInfo™ 2 Configuration Interface Board for use with PS70X and PS50X
PS052	PowerCal™ 2 Configuration Interface Board for use with PS70X and PS50X
PS070*	PowerMate™ Development Software for PS700 Applications
PS2070*	PS200 Configurable Battery Charger Evaluation Board
PS2070EV*	PS200 Configurable Battery Charger Evaluation Board with PS051 PowerInfo™ 2
PS5100	PS501 6-12 cell NiMH Module
PS5100EV	PS501 6-12 cell NiMH Module with PS051
PS5162	2-cell Li-Ion/Poly Fuel Gauge with safety
PS5162EV	2-cell Li-Ion/Poly Fuel Gauge with safety and PS051 PowerInfo™ 2
PS5163	3-cell Li-Ion/Poly Fuel Gauge with safety
PS5163EV	3-cell Li-Ion/Poly Fuel Gauge with safety and PS051 PowerInfo™ 2
PS5164	4-cell Li-Ion/Poly Fuel Gauge with safety
PS5164EV	4-cell Li-Ion/Poly Fuel Gauge with safety and PS051 PowerInfo™ 2
PS7051	Single Cell Li-Ion Battery Monitor with safety
PS7052	Two Cell Li-Ion Battery Monitor with safety
PS7070	PS700 Battery Monitor Evaluation Board
PS7070EV	PS700 Battery Monitor Evaluation Board with PS051 PowerInfo™ 2
PS8070*	PS8X0 Li-Ion/Poly Single Cell Fuel Gauge
PS8070EV*	PS8X0 Li-Ion/Poly Single Cell Fuel Gauge with PS051 PowerInfo™ 2

* Contact Microchip web site at www.microchip.com for availability.

Memory Evaluation/Developer's Kits

SEEVAL® 32 Serial EEPROM Developer's Kit	DV243002	All serial EEPROMS, 24XX, 93XX, 25XX series
--	----------	---

KEELOQ® Evaluation Kits

	HCS101	HCS200/201	HCS300/301/320	HCS360/361	HCS362	HCS365/370	HCS410/412	HCS473	HCS500/515	HCS512
KEELOQ® Transponder Evaluation Kit*	–	–	–	–	–	–	DM303005	–	–	
KEELOQ® Evaluation Kit II*	DM303006	DM303006	DM303006	DM303006	DM303006	DM303006	DM303006	DM303006	DM303006	
PRO MATE® II Universal Programmer for SOIC*	AC004002	AC004002	AC004002	AC004002	AC004002	AC004003	AC004002	AC004003	–	AC164002
PRO MATE® II Universal Programmer for DIP*	AC004001	AC004001	AC004001	AC004001	AC004001	AC004007	AC004001	AC004007	–	AC164001
PRO MATE® II Universal Programmer for ICSP™*	AC004004	AC004004	AC004004	AC004004	AC004004	AC004004	AC004004	AC004004	AC004004	

* Support is limited to PRO MATE® II using MPLAB® IDE release 5.70.

RFID Evaluation/Developer's Kits		
	MCRF355	MCRF450/452
13.56 MHz Anti-Collision microID [®] Developer's Kit	DV103003, DV103006	DV103006
microID [®] Programmer Kit only for MCRF355	PG103003	-

Analog / Interface Demo/Eval/Developer's Kits

Interface	Part Number	Devices Supported
MCP2140 IrDA [®] Wireless Temp. Demo	MCP2140DM-TMPSNS	MCP2140
MCP215X Data Logger Demo Board	MCP215XDM	MCP2150/55
MCP250XX CAN I/O Expanders Developer's Kit	DV250501	MCP25020, MCP25025, MCP25050, MCP25055
MCP2510/2515 CAN Developer's Kit	DV251001	MCP2510, MCP2515
MCP2120/2150 Developer's Kit	DM163008	MCP2120, MCP2150
MCP23X08 Evaluation Board	MCP23X08EV	MCP23008, MCP23S08
Linear	Part Number	Devices Supported
MCP6S22 PGA PICtail™ Demo Board	MCP6S22DM-PICTL	MCP6S22/92
MCP6SX2 PGA Photodiode PICtail™ Demo Board	MCP6SX2DM-PCTLPD	MCP6S22/92
MCP6SX2 PGA Thermistor PICtail™ Demo Board	MCP6SX2DM-PCTLTH	MCP6S22/92
MCP6S2X PGA Evaluation Board	MCP6S2XEV	MCP6S2X
Mixed Signal	Part Number	Devices Supported
Mixed Signal PICtail™ Demo Board	MXSIGDM	TX132X, MCP330X, MCP320X, MCP494X, MCP3221, MCP3201, MCP1525, MCP1541
Evaluation Kit for Sigma-Delta A/D Converter Family	TX3400EV	TX3400X
Single-Dual A/D	DV3201A	MCP3001, MCP3002, MCP3201, MCP3202
MCP3201/02 Evaluation System Daughter Board	DV3201A	MCP3201/02
MXDEV Analog Evaluation System	DVMCPA	MCP3001/02, MCP3004/08, MCP3201/02, MCP3204/08
MCP3204/08 Evaluation System Daughter Board	DV3204A	MCP3204, MCP3208
MCP42XXX Digital Pot Evaluation Kit	DV42XXX	MCP42010, MCP42050, MCP42100
Power Management	Part Number	Devices Supported
MCP1612 Synchronous Buck Regulator Evaluation Board	MCP1612EV	MCP1612
MCP1630 +12V Dual Output Buck Converter Ref. Design	MCP1630RD-DDBK1	MCP1630
MCP1630 Li-Ion Multi Bay Battery Charger Ref. Design	MCP1630RD-LIC1	MCP1630
MCP1630 NiMH Battery Charger Demo Board	MCP1630DM-NMC1	MCP1630
MCP1601 Buck Regulator Evaluation Board	MCP1601EV	MCP1601
Voltage Supervisor Evaluation Board	VSUPEV	SOT-23 packages
MCP7386X Li-Ion Battery Charger Evaluation Board	MCP7386XEV	MCP73861/62
MCP165X 3W White LED Demo Board	MCP1650DM-LED1	MCP1650/51
MCP1650 Boost Controller Evaluation Board	MCP1650EV	MCP1650
MCP7384X Li-Ion Battery Charger	MCP7384XEV	MCP7384X
MCP7382X Li-Ion Battery Charger	MCP7382XEV	MCP7382X
MCP73855 Evaluation Board	MCP73855EV	MCP73855
Voltage Supervisor SOT23-5/6 Evaluation Board	VSUPEV2	SOT23-5/6-lead packages

Analog / Interface Demo/Eval/Developer's Kits

Thermal Management Tools	Part Number	Devices Supported
MCP9800 Thermal Sensor PICtail™ Demo Board	MCP9800DM-PCTL	MCP9800
Demo Board for Tiny Serial Digital Thermal Sensor	TC74DEMO	TC74
Fan Controller Demo Board for TC652	TC652DEMO	TC652
Fan Controller Demo Board for TC650	TC650DEMO	TC650
Evaluation Kit for the Fan Speed Controllers	TC642EV	
TC72 Digital Temperature Sensor	TC72DM-PICTL	TC72
TC77 Thermal Sensor PICtail™ Demo	TC77DM-PICTL	TC77
Demo Board for Fan Speed Controllers	TC642DEMO	TC642
TC1047A Temperature to Voltage	TC1047ADM-PICTL	

FUTURE MICROCHIP MICROCONTROLLER PRODUCTS

Baseline 8-Bit PICmicro® Microcontroller Family (12-bit Instruction Set)

Product	Program Memory: Bytes & Type (Words)	EEPROM Data Memory Bytes	RAM Bytes	I/O Pins	Packages	Analog		Digital		Max. Speed MHz	IntOSC	ICSP™	BOR/PBOR/PLVD	ICD # of Breakpoints	CCP/ECCP	nW	Other Features
						ADC Channels	Comp.	Timers/WDT	Serial I/O								
PIC10FXXX: 500 ns Instruction Execution, 33 Instructions																	
PIC10F220	384 StdFI (256)	—	16	4	8P, 60T	3	—	1-8 bit, 1-WDT	—	8	8 MHz	✓	—	1**	—	—	Band gap reference
PIC10F222	768 StdFI (512)	—	24	4	8P, 60T	3	—	1-8 bit, 1-WDT	—	8	8 MHz	✓	—	1**	—	—	Band gap reference
PIC12FXXX: 500 ns Instruction Execution, 33 Instructions																	
PIC12F510	1536 StdFI (1024)	—	38	6	8P, 8SN, 8MS	3x8-bit	1	1-8 bit, 1-WDT	—	8	8 MHz	✓	—	1**	—	—	Band gap reference
PIC16FXXX: Upwardly Compatible with PIC16C5X/PIC12CXXX, 4-12 Interrupts, 200 ns Instruction Execution, 35 Instructions, 20 mA source and 25 mA sink per I/O																	
PIC16F506	1536 StdFI (1024)	—	67	12	14P, 14SO, 14ST	3x8-bit	2	1-8 bit, 1-WDT	—	20	8 MHz	✓	—	1**	—	—	Band gap reference

** Requires ICD specific device with header module – refer to Development Tools. Abbreviations are found on the last page of the Selector Guide.

Mid-Range 8-Bit PICmicro® Microcontroller Family (14-bit Instruction Set)

Product	Program Memory: Bytes & Type (Words)	EEPROM Data Memory Bytes	RAM Bytes	I/O Pins	Packages	Analog		Digital		Max. Speed MHz	IntOSC	BOR/PBOR/PLVD	ICD # of Breakpoints	CCP/ECCP	nW	Other Features	
						ADC Channels	Comp.	Timers/WDT	Serial I/O								
PIC16FXXX: Upwardly Compatible with PIC16C5X/PIC12CXXX, 4-12 Interrupts, 200 ns Instruction Execution, 35 Instructions, ICSP™																	
PIC16F631	1792 StdFI (1024)	128	64	18	20P, 20SO, 20SS	—	2	1-16 bit, 1-8 bit, 1-WDT	—	20	8 MHz	BOR	1**	—	✓		
PIC16F677	3584 StdFI (2048)	256	128	18	20P, 20SO, 20SS	12x10-bit	2	1-16 bit, 1-8 bit, 1-WDT	—	20	8 MHz	BOR	1**	—	✓		

** Requires ICD specific device with header module – refer to Development Tools. Abbreviations are found on the last page of the Selector Guide.

High Performance 8-Bit PICmicro® Microcontroller Family (16-bit Instruction Set)

Product	Program Memory: Bytes & Type (Words)	EEPROM Data Memory Bytes	RAM Bytes	I/O Pins	Packages	Analog		Digital		Max. Speed MHz	IntOSC	BOR/PBOR/PLVD	ICD # of Breakpoints	CCP/ECCP	nW	Other Features	
						ADC Ch	Comp.	Timers/WDT	Serial I/O								
PIC18FXXX: Upwardly Compatible with PIC17C7XX/PIC16CXX/PIC16C5X/PIC12CXXX, 77 Instructions, C Compiler Efficient Instruction Set, Software Stack Capability, Table Read/Write, Switchable Oscillator Sources, 4x PLL, 10-12 MIPS, ICSP™																	
PIC18F2221	4096 EnhFI (2048)	256	512	25	28SP, 28SO, 28ML	10x10-bit, 100 ksp/s	2	3-16 bit, 1-8 bit, 1-WDT	EUSART, MI ² C/SPI	40	8 MHz	PBOR/PLVD	3	2/0	✓	PSP	
PIC18F2321	8192 EnhFI (4096)	256	512	25	28SP, 28SO, 28ML	10x10-bit, 100 ksp/s	2	3-16 bit, 1-8 bit, 1-WDT	EUSART, MI ² C/SPI	40	8 MHz	PBOR/PLVD	3	2/0	✓	PSP	
PIC18F4221	4096 EnhFI (2048)	256	512	36	40P, 44ML, 44PT	13x10-bit, 100 ksp/s	2	3-16 bit, 1-8 bit, 1-WDT	EUSART, MI ² C/SPI	40	8 MHz	PBOR/PLVD	3	1/1	✓	PSP	
PIC18F4321	8192 EnhFI (4096)	256	512	36	40P, 44ML, 44PT	13x10-bit, 100 ksp/s	2	3-16 bit, 1-8 bit, 1-WDT	EUSART, MI ² C/SPI	40	8 MHz	PBOR/PLVD	3	1/1	✓	PSP	
PIC18F24J10	16,384 StdFI (8192)	—	1024	21	28SP, 28SO, 28SS	10x10-bit, 100 ksp/s	2	2-16 bit, 1-8 bit, 1-WDT	EUSART, MI ² C/SPI	40	32 kHz	—	3	2/0	✓	PSP	

Abbreviations are found on the last page of the Selector Guide.

Product	Program Memory: Bytes & Type (Words)	EEPROM Data Memory Bytes	RAM Bytes	I/O Pins	Packages	Analog		Digital		Max. Speed MHz	IntOSC	BOR/PBOR/PLVD	ICD # of Breakpoints	CCP/ECCP	nW	Other Features
						ADC Ch	Comp.	Timers/WDT	Serial I/O							
PIC18FXXX: Upwardly Compatible with PIC17C7XX/PIC16CXX/PIC16C5X/PIC12CXXX, 77 Instructions, C Compiler Efficient Instruction Set, Software Stack Capability, Table Read/Write, Switchable Oscillator Sources, 4x PLL, 10-12 MIPS, ICSP™ (continued)																
PIC18F25J15	32,768 StdFI (16384)	—	1024	21	28SP, 28SO, 28SS	10x10-bit, 100 ksps	2	2-16 bit, 1-8 bit, 1-WDT	EUSART, MI ² C/SPI	40	32 kHz	—	3	2/0	✓	PSP
PIC18F44J10	16,384 StdFI (8192)	—	1024	32	40P, 44ML, 44PT	13x10-bit, 100 ksps	2	2-16 bit, 1-8 bit, 1-WDT	EUSART, 2x MI ² C/SPI	40	32 kHz	—	3	1/1	✓	PSP
PIC18F45J15	32,768 StdFI (16384)	—	1024	32	40P, 44ML, 44PT	13x10-bit, 100 ksps	2	2-16 bit, 1-8 bit, 1-WDT	EUSART, 2x MI ² C/SPI	40	32 kHz	—	3	1/1	✓	PSP
PIC18F65J10	32,768 StdFI (16384)	—	2048	51	64PT	11x10-bit, 100 ksps	2	3-16 bit, 2-8 bit, 1-WDT	2x EUSART, 2x MI ² C/SPI	40	32 kHz	BOR	3	2/3	✓	PSP
PIC18R65J10	32,768 ROM (16384)	—	2048	51	64PT	11x10-bit, 100 ksps	2	3-16 bit, 2-8 bit, 1-WDT	2x EUSART, 2x MI ² C/SPI	40	32 kHz	BOR	3	2/3	✓	PSP
PIC18F65J15	49,152 StdFI (24576)	—	2048	51	64PT	11x10-bit, 100 ksps	2	3-16 bit, 2-8 bit, 1-WDT	2x EUSART, 2x MI ² C/SPI	40	32 kHz	BOR	3	2/3	✓	PSP
PIC18F66J10	65,536 StdFI (32768)	—	2048	51	64PT	11x10-bit, 100 ksps	2	3-16 bit, 2-8 bit, 1-WDT	2x EUSART, 2x MI ² C/SPI	40	32 kHz	BOR	3	2/3	✓	PSP
PIC18R66J10	65,536 ROM (32768)	—	2048	51	64PT	11x10-bit, 100 ksps	2	3-16 bit, 2-8 bit, 1-WDT	2x EUSART, 2x MI ² C/SPI	40	32 kHz	BOR	3	2/3	✓	PSP
PIC18F66J60	65,536 StdFI (32768)	—	3808	39	64PT	11x10-bit, 100 ksps	2	3-16 bit, 2-8 bit, 1-WDT	1x EUSART, 1x MI ² C/SPI	42	32 kHz	BOR	3	2/3	✓	10 BASE-T Ethernet
PIC18F66J65	98,304 StdFI (49152)	—	3808	39	64PT	11x10-bit, 100 ksps	2	3-16 bit, 2-8 bit, 1-WDT	1x EUSART, 1x MI ² C/SPI	42	32 kHz	BOR	3	2/3	✓	10 BASE-T Ethernet
PIC18R67J10	131,072 ROM (65536)	—	3936	51	64PT	11x10-bit, 100 ksps	2	3-16 bit, 2-8 bit, 1-WDT	2x EUSART, 2x MI ² C/SPI	40	32 kHz	BOR	3	2/3	✓	PSP
PIC18F67J60	131,072 StdFI (65536)	—	3808	39	64PT	11x10-bit, 100 ksps	2	3-16 bit, 2-8 bit, 1-WDT	1x EUSART, 1x MI ² C/SPI	42	32 kHz	BOR	3	2/3	✓	10 BASE-T Ethernet
PIC18F85J10	32,768 StdFI (16384)	—	2048	67	80PT	15x10-bit, 100 ksps	2	3-16 bit, 2-8 bit, 1-WDT	2x EUSART, 2x MI ² C/SPI	40	32 kHz	BOR	3	2/3	✓	PSP, EMA
PIC18R85J10	32,768 ROM (16384)	—	2048	67	80PT	15x10-bit, 100 ksps	2	3-16 bit, 2-8 bit, 1-WDT	2x EUSART, 2x MI ² C/SPI	40	32 kHz	BOR	3	2/3	✓	PSP, EMA
PIC18F85J15	49,152 StdFI (24576)	—	2048	67	80PT	15x10-bit, 100 ksps	2	3-16 bit, 2-8 bit, 1-WDT	2x EUSART, 2x MI ² C/SPI	40	32 kHz	BOR	3	2/3	✓	PSP, EMA
PIC18F86J10	65,536 StdFI (32768)	—	3936	67	80PT	15x10-bit, 100 ksps	2	3-16 bit, 2-8 bit, 1-WDT	2x EUSART, 2x MI ² C/SPI	40	32 kHz	BOR	3	2/3	✓	PSP, EMA
PIC18R86J10	65,536 ROM (32768)	—	3936	67	80PT	15x10-bit, 100 ksps	2	3-16 bit, 2-8 bit, 1-WDT	2x EUSART, 2x MI ² C/SPI	40	32 kHz	BOR	3	2/3	✓	PSP, EMA
PIC18F86J60	65,536 StdFI (32768)	—	3808	55	80PT	15x10-bit, 100 ksps	2	3-16 bit, 2-8 bit, 1-WDT	2x EUSART, 1x MI ² C/SPI	42	32 kHz	BOR	3	2/3	✓	10 BASE-T Ethernet
PIC18F86J65	98,304 StdFI (49152)	—	3808	55	80PT	15x10-bit, 100 ksps	2	3-16 bit, 2-8 bit, 1-WDT	2x EUSART, 1x MI ² C/SPI	42	32 kHz	BOR	3	2/3	✓	10 BASE-T Ethernet
PIC18R87J10	131,072 ROM (65536)	—	3936	67	80PT	15x10-bit, 100 ksps	2	3-16 bit, 2-8 bit, 1-WDT	2x EUSART, 2x MI ² C/SPI	40	32 kHz	BOR	3	2/3	✓	PSP, EMA
PIC18F87J60	131,072 StdFI (65536)	—	3808	55	80PT	15x10-bit, 100 ksps	2	3-16 bit, 2-8 bit, 1-WDT	2x EUSART, 1x MI ² C/SPI	42	32 kHz	BOR	3	2/3	✓	10 BASE-T Ethernet

Abbreviations are found on the last page of the Selector Guide.

Product	Program Memory: Bytes & Type (Words)	EEPROM Data Memory Bytes	RAM Bytes	I/O Pins	Packages	Analog		Digital		Max. Speed MHz	IntOSC	BOR/PBOR/PLVD	ICD # of Breakpoints	CCP/ECCP	nW	Other Features
						ADC Ch	Comp.	Timers/WDT	Serial I/O							
PIC18FXXX: Upwardly Compatible with PIC17C7XX/PIC16CXX/PIC16C5X/PIC12CXXX, 77 Instructions, C Compiler Efficient Instruction Set, Software Stack Capability, Table Read/Write, Switchable Oscillator Sources, 4x PLL, 10-12 MIPS, ICSP™ (continued)																
PIC18F6522	32,768 EnhFI (16384)	1024	2048	54	64PT	12x10-bit, 100 ksps	2	3-16 bit, 2-8 bit, 1-WDT	2x EUSART, 2x MI ² C/SPI	40	8 MHz	PBOR	3	2/3	✓	PSP
PIC18F8522	32,768 EnhFI (16384)	1024	2048	70	80PT	16x10-bit, 100 ksps	2	3-16 bit, 2-8 bit, 1-WDT	2x EUSART, 2x MI ² C/SPI	40	8 MHz	PBOR	3	2/3	✓	PSP, EMA
PIC18F96J60	65,536 StdFI (32768)	—	3808	70	100PT	16x10-bit, 100 ksps	2	3-16 bit, 2-8 bit, 1-WDT	2x EUSART, 2x MI ² C/SPI	42	32 kHz	BOR	3	2/3	✓	PSP, EMA, 10 BASE-T Ethernet
PIC18F96J65	98,304 StdFI (49152)	—	3808	70	100PT	16x10-bit, 100 ksps	2	3-16 bit, 2-8 bit, 1-WDT	2x EUSART, 2x MI ² C/SPI	42	32 kHz	BOR	3	2/3	✓	PSP, EMA, 10 BASE-T Ethernet
PIC18F97J60	131,072 StdFI (65536)	—	3808	70	100PT	16x10-bit, 100 ksps	2	3-16 bit, 2-8 bit, 1-WDT	2x EUSART, 2x MI ² C/SPI	42	32 kHz	BOR	3	2/3	✓	PSP, EMA, 10 BASE-T Ethernet

Abbreviations are found on the last page of the Selector Guide.

dsPIC® DIGITAL SIGNAL CONTROLLER (DSC) PRODUCTS

Product	Program (FLASH) Kbytes	Memory (FLASH) K Words	EE Bytes	SRAM Bytes	I/O Pins (max.)	Packages	A/D 12-bit 100 ksps	A/D 10-bit 500 ksps	Timer 16-bit	Input Cap	Output Comp/Std PWM	Motor Control PWM	Quad Enc.	UART	SPI™	I ² C™	CAN	Codec Interface	
dsPIC30F Motor Control and Power Conversion Family																			
dsPIC30F5015	66	22	1024	2048	52	64PT	—	16 ch	5	4	4	8	✓	1	2	1	1	—	
dsPIC30F6015	144	48	4096	8192	52	64PT	—	16 ch	5	6	6	8	✓	2	2	1	1	—	
dsPIC30F5016	66	22	1024	2048	68	80PT	—	16 ch	5	4	4	8	✓	1	2	1	1	—	
dsPIC30F6010A	144	48	4096	8192	68	80PF (14x14), 80PT (12x12)	—	16 ch	5	8	8	8	✓	2	2	1	2	—	
dsPIC30F General Purpose Family																			
dsPIC30F6011A	132	44	2048	6144	52	64PF (12x12), 64PT (10x10)	16 ch	—	5	8	8	—	—	2	2	1	2	—	
dsPIC30F6012A	144	48	4096	8192	52	64PF (12x12), 64PT (10x10)	16 ch	—	5	8	8	—	—	2	2	1	2	AC97, I ² S	
dsPIC30F6013A	132	44	2048	6144	68	80PF (14x14), 80PT (12x12)	16 ch	—	5	8	8	—	—	2	2	1	2	—	
dsPIC30F6014A	144	48	4096	8192	68	80PF (14x14), 80PT (12x12)	16 ch	—	5	8	8	—	—	2	2	1	2	AC97, I ² S	

Abbreviations are found on the last page of the Selector Guide.

Battery Management Family Products

Product	Battery Chemistry	# of Cells	Interface	A/D Converter	Programmable Memory	Programmable I/O Functions	Accuracy	Time Base	Safety	Temp. Sensor	Packaging	Description
Battery Fuel Gauge ICs												
PS830	Li-Ion	1	SMBus/SPS	16-bit Sigma Delta	4k x 16 Flash	3 GPIO	1%	On-chip	Internal	On-chip	14ST, 16ML	Single cell Li-Ion fuel gauge with integrated safety provides battery status such as run time to empty, run time to full, relative state-of-charge and battery state-of-health

Abbreviations are found on the last page of the Selector Guide.

SERIAL ELECTRICALLY ERASABLE PROMS (EEPROM)

Part #	E/W Cycles	Density (Organization)	Page Size	Write Speed	Max. Clock Freq.	Operating Voltage (V)	Temps	Unique Features	Packages ^(Note)
SPI™ Compatible Serial EEPROM Family – Page Write mode, HOLD pin, software enabled block write protection and hardware write-protect pin									
25LC010A	1M	1 Kbit (x8)	16B	5 ms	10 MHz	2.5 to 5.5	I, E		P, SN, ST, MS, MC, OT
25AA010A	1M	1 Kbit (x8)	16B	5 ms	10 MHz	1.8 to 5.5	I		P, SN, ST, MS, MC, OT
25LC020A	1M	2 Kbit (x8)	16B	5 ms	10 MHz	2.5 to 5.5	I, E		P, SN, ST, MS, MC, OT
25AA020A	1M	2 Kbit (x8)	16B	5 ms	10 MHz	1.8 to 5.5	I		P, SN, ST, MS, MC, OT
25LC040A	1M	4 Kbit (x8)	16B	5 ms	10 MHz	2.5 to 5.5	I, E		P, SN, ST, MS, MC, OT
25AA040A	1M	4 Kbit (x8)	16B	5 ms	10 MHz	1.8 to 5.5	I		P, SN, ST, MS, MC, OT
25LC320A	1M	32 Kbits (x8)	32B	5 ms	10 MHz	2.5 to 5.5	I, E		P, SN, ST, MS
25AA320A	1M	32 Kbits (x8)	32B	5 ms	10 MHz	1.8 to 5.5	I, E		P, SN, ST, MS
25LC640A	1M	64 Kbits (x8)	32B	5 ms	10 MHz	2.5 to 5.5	I, E		P, SN, ST, MS
25AA640A	1M	64 Kbits (x8)	32B	5 ms	10 MHz	1.8 to 5.5	I		P, SN, ST, MS
25LC128	1M	128 Kbits (x8)	64B	5 ms	10 MHz	2.5 to 5.5	I, E		P, SN, ST, MS
25AA128	1M	128 Kbits (x8)	64B	5 ms	10 MHz	1.8 to 5.5	I		P, SN, ST, MS
25LC1024	1M	1 Mbit (x8)	256B	5 ms	20 MHz	2.5 to 5.5	I, E		P, SM, MF
25AA1024	1M	1 Mbit (x8)	256B	5 ms	20 MHz	1.8 to 5.5	I		P, SM, MF
I²C™ Compatible Serial EEPROM Family									
24LC1025	1M	1 Mbit (x8)	—	5 ms	400 kHz	2.5 to 5.5	I, E	Cascade up to 4 devices, 100 kHz @ 1.8V-2.5V	P, SM
24AA1025	1M	1 Mbit (x8)	—	5 ms	400 kHz	1.8 to 5.5	I	Cascade up to 4 devices, 100 kHz @ 1.8V-2.5V	P, SM

NOTE: All packaging for these products will be Pb-free.

ANALOG/INTERFACE PRODUCTS

Power Management – Switching Regulators

Part #	Description	Input Voltage Range (V)	Output Voltage Range (V)	Operating Temperature Range (°C)	Control Scheme	Switching Frequency (kHz)	Typical Active Current (mA)	Output Current (mA)	Features	Packages
MCP1603	Synchronous Buck Regulator	2.5 to 5.5	0.8 to 4.5	-40 to +85	PFM/PWM	2000	0.035	500	Auto switching PWM to PFM, adjustable and fixed output versions	5-Pin SOT-23, 8-Pin 3x2 DFN
MCP1614	Dual Synchronous Buck DC-DC converter	2.7 to 5.5	0.8 to 5.5	-40 to +85	Constant frequency PWM	1400	18	1000/1000	Overall efficiency > 94%, soft start, over-temperature and over current protection	16-Pin QSOP

Power Management – CPU/System Supervisors

Part #	Vcc Range (V)	Operating Temperature Range (°C)	Nominal Reset Voltage (V)	Reset Type	Output	Typical Reset Pulse Width (ms)	Typical Supply Current (µA)	Features	Packages
MCP1316	1.0 to 5.5	-40 to +125	2.9, 4.6	Active Low	CMOS Push-Pull	200	5	Watchdog Input (WDI timeout = 1.6s), Manual Reset	5-Pin SOT-23
MCP1317	1.0 to 5.5	-40 to +125	2.9, 4.6	Active High	CMOS Push-Pull	200	5	Watchdog Input (WDI timeout = 1.6s), Manual Reset	5-Pin SOT-23
MCP1318	1.0 to 5.5	-40 to +125	4.6	Active Low/High	CMOS Push-Pull	200	5	Watchdog Input (WDI timeout = 1.6s)	5-Pin SOT-23
MCP1319	1.0 to 5.5	-40 to +125	4.6	Active Low/High	CMOS Push-Pull	200	1	Manual Reset	5-Pin SOT-23
MCP1320	1.0 to 5.5	-40 to +125	2.9, 4.6	Active Low	Open Drain	200	5	Watchdog Input (WDI timeout = 1.6s), Manual Reset	5-Pin SOT-23
MCP1321	1.0 to 5.5	-40 to +125	4.6	Active Low	Open Drain/CMOS Push-Pull	200	5	Watchdog Input (WDI timeout = 1.6s), Two reset outputs (Active Low Open-Drain, Active High Push-Pull)	5-Pin SOT-23
MCP1322	1.0 to 5.5	-40 to +125	4.6	Active High	Open Drain/CMOS Push-Pull	200	1	Manual Reset, Two reset outputs (Active Low Open-Drain, Active High Push-Pull)	5-Pin SOT-23

Linear – Operational Amplifiers

Part #	Channels	GBWP	Iq Typ.	Vos	Operating Voltage (V)	Temperature Range (°C)	Features	Packages
MCP6234	4	300 kHz	20 µA	7 mV	1.8 to 5.5	-40° to +125	Rail-to-Rail Input/Output	14-Pin PDIP, 14-Pin SOIC, 14-Pin TSSOP
MCP6244	4	650 kHz	50 µA	7 mV	1.8 to 5.5	-40° to +125	Rail-to-Rail Input/Output	14-Pin PDIP, 14-Pin SOIC, 14-Pin TSSOP

Linear – Linear Gain Blocks								
Part #	Channels	-3dB BW (kHz)	I _Q (μA)	V _{OS} (mV)	Operating Voltage (V)	Temperature Range (°C)	Gain Steps (V/V)	Packages
MCP6G01	1	1	120	3	1.8 to 5.5	-40 to +125	1, 10, 50	8-Pin PDIP, 8-Pin SOIC, 8-Pin TSSOP
MCP6G02	2	1	120	3	1.8 to 5.5	-40 to +125	1, 10, 50	8-Pin PDIP, 8-Pin SOIC, 8-Pin TSSOP
MCP6G04	4	1	120	3	1.8 to 5.5	-40 to +125	1, 10, 50	14-Pin PDIP, 14-Pin SOIC, 14-Pin TSSOP
MCP6G41	1	14 to 100	2	3	1.8 to 5.5	-40 to +125	1, 10, 50	8-Pin PDIP, 8-Pin SOIC, 8-Pin MSOP
MCP6G42	2	14 to 100	2	3	1.8 to 5.5	-40 to +125	1, 10, 50	8-Pin PDIP, 8-Pin SOIC, 8-Pin MSOP
MCP6G44	4	14 to 100	2	3	1.8 to 5.5	-40 to +125	1, 10, 50	14-Pin PDIP, 14-Pin SOIC, 14-Pin TSSOP

Mixed Signal - SAR A/D Converters										
Part #	Resolution (bits)	Maximum Sampling Rate (ksamples/sec)	# of Input Channels	Input Type	Interface	Input Voltage Range (V)	Maximum Supply current (mA)	Maximum INL (LSB)	Temperature Range (°C)	Packages
MCP3601	16	100	1	Single-ended	SPI	2.7 to 5.5	750	±3	-40 to +125	8-Pin PDIP, 8-Pin MSOP, 8-Pin SOIC
MCP3602	16	100	2	Single-ended	SPI	2.7 to 5.5	1000	±3	-40 to +125	8-Pin PDIP, 8-Pin MSOP, 8-Pin SOIC
MCP3604	16	100	4	Single-ended	SPI	2.7 to 5.5	750	±3	-40 to +125	14-Pin PDIP, 14-Pin SOIC, 14-Pin TSSOP
MCP3608	16	100	8	Single-ended	SPI	2.7 to 5.5	750	±3	-40 to +125	16-Pin PDIP, 16-Pin SOIC

Mixed Signal – Delta-Sigma A/D Converters							
Part #	Resolution (bits)	Maximum Sampling Rate (samples/sec)	# Input Channels	Interface	Typical Supply Current (μA)	Supply Voltage Range (V)	Packages
MCP3551	22	15	1	SPI™	150	2.7 to 5.5	8-Pin SOIC, 8-Pin MSOP

Mixed Signal - D/A Converters									
Part #	Resolution (bits)	DACs per package	Interface	Internal V _{REF}	Output Settling Time (μs)	DNL (LSB)	Typical Standby Current (μA)	Typical Operating Current (μA)	Packages
MCP4821	12	1	SPI	Y	4.5	1	1	200	8-Pin PDIP, 8-Pin SOIC, 8-Pin MSOP
MCP4822	12	2	SPI	Y	4.5	1	1	400	8-Pin PDIP, 8-Pin SOIC, 8-Pin MSOP

Interface – Serial Products							
Part #	Description	Operating Voltage (V)	Operating Temperature Range (°C)	Bus Type	Max. Bus Frequency (kHz)	Unique Features	Packages
MCP23017	16-bit I/O expander	1.8 to 5.5	-40 to +125	I ² C™	1,700	3 HW address pins, 25 mA sink/source per I/O, 100 kHz, 400 kHz and 3-4 MHz I2C supported, Interrupt output	28-Pin PDIP, 28-Pin SOIC, 28-Pin SSOP, 28-Pin QFN
MCP23S17	16-bit I/O expander	1.8 to 5.5	-40 to +125	SPI™	10,000	3 HW address pins, 25 mZ sink/source per I/O, Interrupt output	28-Pin PDIP, 28-Pin SOIC, 28-Pin SSOP, 28-Pin QFN

FUTURES

PIN AND CODE COMPATIBILITY CHART

8-pin PICmicro® MCU Family

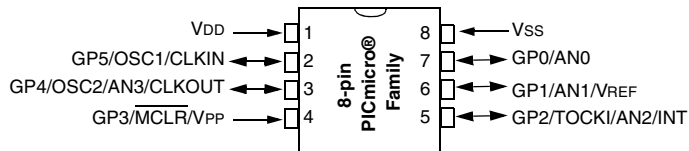

PIC12C508A	PIC12C671	PIC12F509
PIC12C509A	PIC12C672	PIC12F629
PIC12CR509A	PIC12CE673	PIC12F635
PIC12CE518	PIC12CE674	PIC12F675
PIC12CE519	PIC12F508	PIC12F683

8-pin KEELoQ® Family

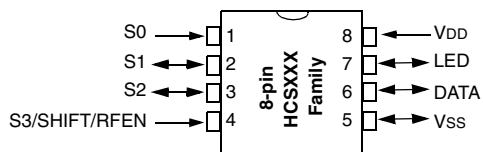

HCS101	HCS300	HCS360
HCS200	HCS301	HCS361
HCS201	HCS320	HCS362
		HCS365

18-pin PICmicro® MCU Family

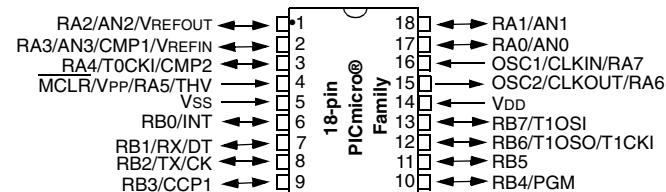

PIC16C620A	PIC16CE625	PIC16C710	PIC16F84A
PIC16CR620A	PIC16F627	PIC16C711	PIC16F818
PIC16C621A	PIC16F628	PIC16C712	PIC16F819
PIC16C622A	PIC16F627A	PIC16C715	PIC16F87
PIC16CE623	PIC16F628A	PIC16C716	PIC16F88
PIC16CE624	PIC16F648A	PIC16F716	PIC16F54
PIC16C54C	PIC16C56A	PIC16C58B	PIC16HV540

8/14/20-pin PICmicro® MCU Family

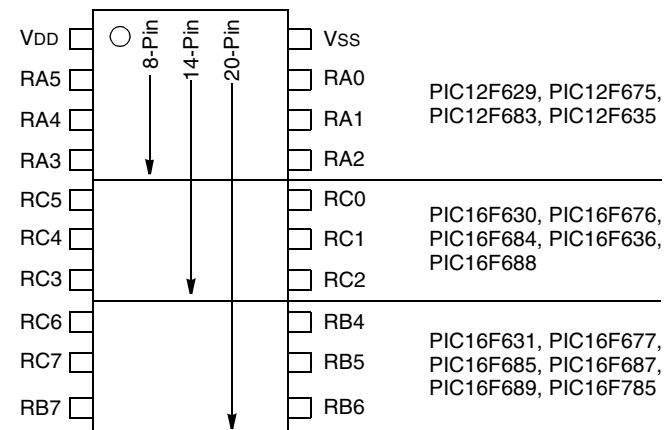

PIC12F629, PIC12F675,
PIC12F683, PIC12F635

PIC16F630, PIC16F676,
PIC16F684, PIC16F636,
PIC16F688

PIC16F631, PIC16F677,
PIC16F685, PIC16F687,
PIC16F689, PIC16F785

28-pin PICmicro® MCU Family

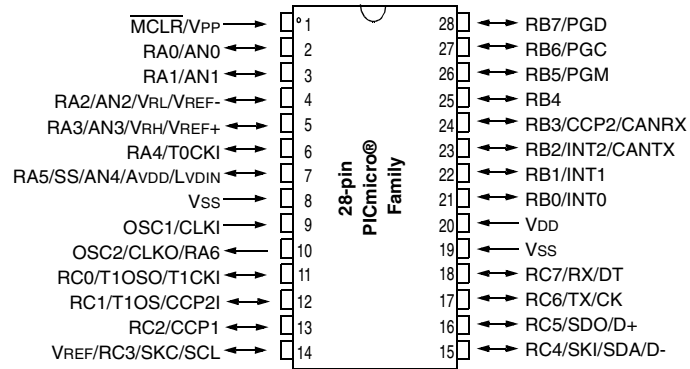

PIC16C62B	PIC16F72	PIC18C242
PIC16CR63	PIC16F73	PIC18C252
PIC16C63A	PIC16F737	PIC18F242
PIC16C642	PIC16F76	PIC18F248
PIC16C66	PIC16F767	PIC18F252
PIC16CR72	PIC16F870	PIC18F258
PIC16C72A	PIC16F872	PIC18F2220
PIC16C73B	PIC16F873	PIC18F2320
PIC16C745	PIC16F873A	PIC18F2455
PIC16C76	PIC16F876	PIC18F2525
PIC16C773	PIC16F876A	PIC18F2550
		PIC18F2620

40-pin PICmicro® MCU Family

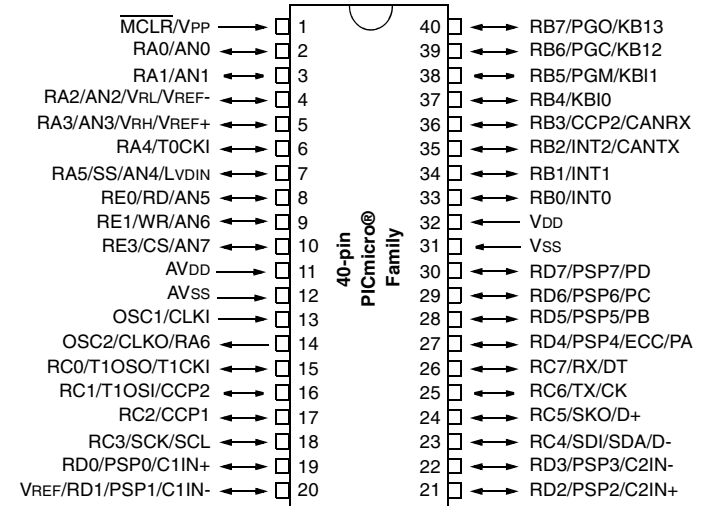

PIC16CR65	PIC16F77	PIC18F448
PIC16C65B	PIC16F777	PIC18F452
PIC16C662	PIC16F871	PIC18F458
PIC16C67	PIC16F874	PIC18F4220
PIC16C74B	PIC16F874A	PIC18F4320
PIC16C765	PIC16F877	PIC18F4455
PIC16C77	PIC16F877A	PIC18F4525
PIC16C774	PIC18C442	PIC18F4550
PIC16F74	PIC18C452	PIC18F4620
PIC16F747	PIC18F442	

64-pin PICmicro® MCU Family

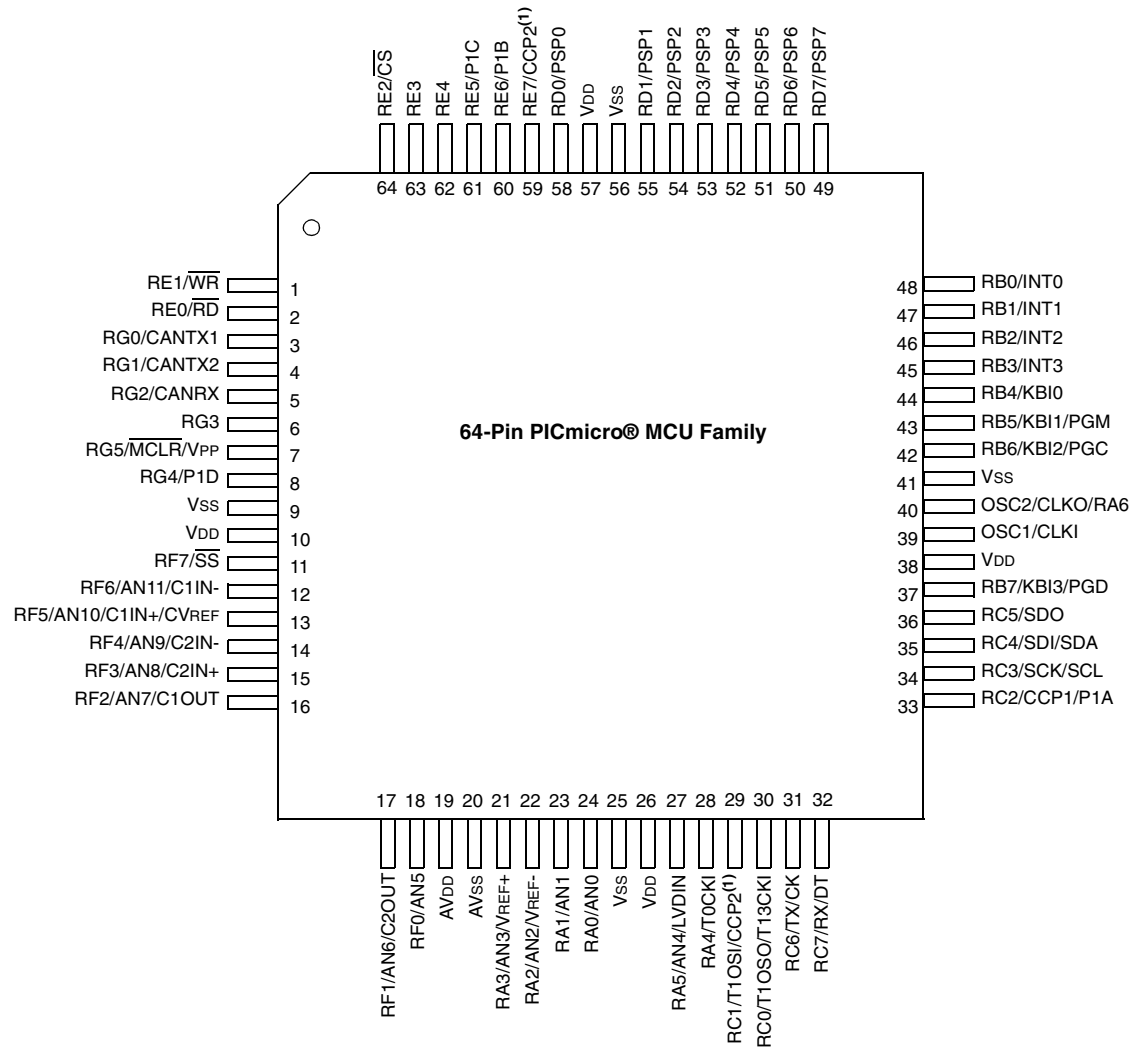

PIC18F6310	PIC18F6525	PIC18F6621
PIC18F6410	PIC18F6585	PIC18F6680
PIC18F6520	PIC18F6620	PIC18F6720

Note 1: CCP2 pin placement depends on CCP2MX setting.

80-pin PICmicro® MCU Family

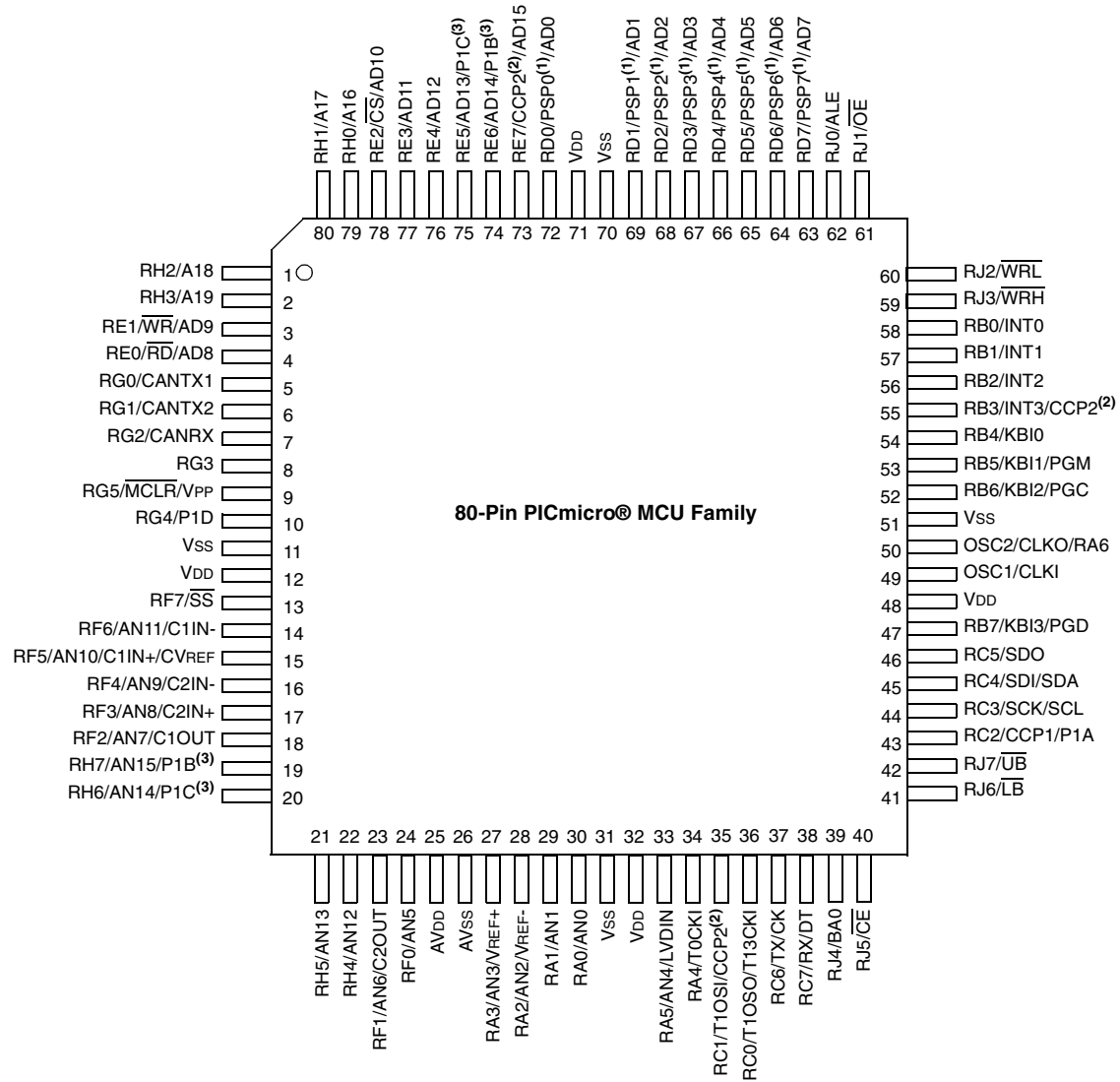

- Note 1:** PSP is available only in Microcontroller mode.
- 2:** CCP2 pin placement depends on CCP2MX and Processor mode settings.
- 3:** P1B and P1C pin placement depends on ECCPMX setting.

- PIC18F8310
- PIC18F8410
- PIC18F8520
- PIC18F8525
- PIC18F8585
- PIC18F8620
- PIC18F8621
- PIC18F8680
- PIC18F8720

**CERAMIC DUAL IN-LINE
CERDIP**



18-LEAD CERDIP
"JW"



20-LEAD CERDIP
"JW"



28-LEAD CERDIP
"JW"



40-LEAD CERDIP
"JW"

**CERAMIC CHIP CARRIER
CERQUAD**



68-LEAD CERQUAD
"CL"



84-LEAD CERQUAD
"CL"

**PLASTIC DUAL IN-LINE
PDIP**



8-LEAD PDIP
"P" OR "PA"



14-LEAD PDIP
"P" OR "PD"



18-LEAD PDIP
"P"



20-LEAD PDIP
"P"



24-LEAD PDIP
"P" OR "PG"



28-LEAD PDIP
"P" OR "PI"



28-LEAD SKINNY PDIP
"SP" OR "PJ"



40-LEAD PDIP
"P" OR "PL"

**PLASTIC QUAD
FLATPACK
"QFP"**



32-LEAD LQFP
"LQ"



44-LEAD MQFP
"PQ"

**PLASTIC LEADED
CHIP CARRIER
PLCC**



32-LEAD PLCC
"L"



44-LEAD PLCC
"L" OR "W"



68-LEAD PLCC
"L" OR "LS"



84-LEAD PLCC
"L"

PACKAGES ARE APPROXIMATE SIZE

**PLASTIC SMALL OUTLINE
"SOIC"**

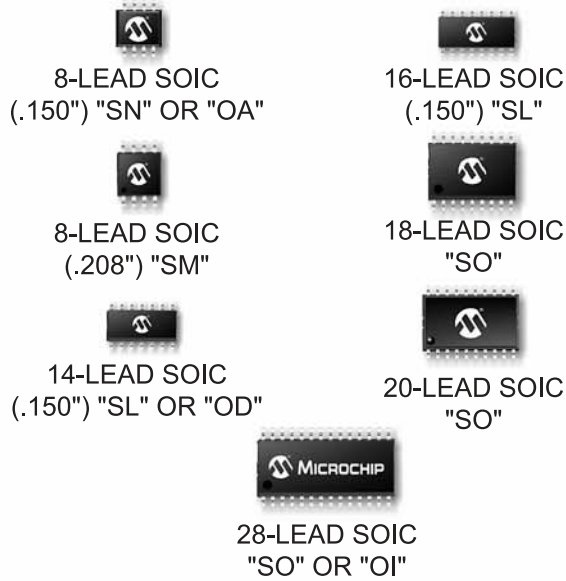

**PLASTIC SHRINK
SMALL OUTLINE
"SSOP"**

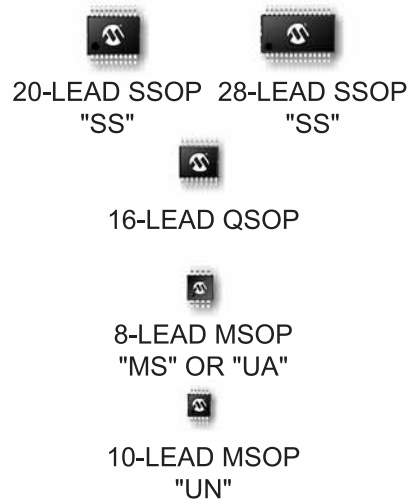

**PLASTIC THIN QUAD
FLATPACK
"TQFP"**



**SIDE BRAZED
DUAL-IN-LINE
"JW"**



**PLASTIC THIN SHRINK
SMALL OUTLINE
"TSOP"**

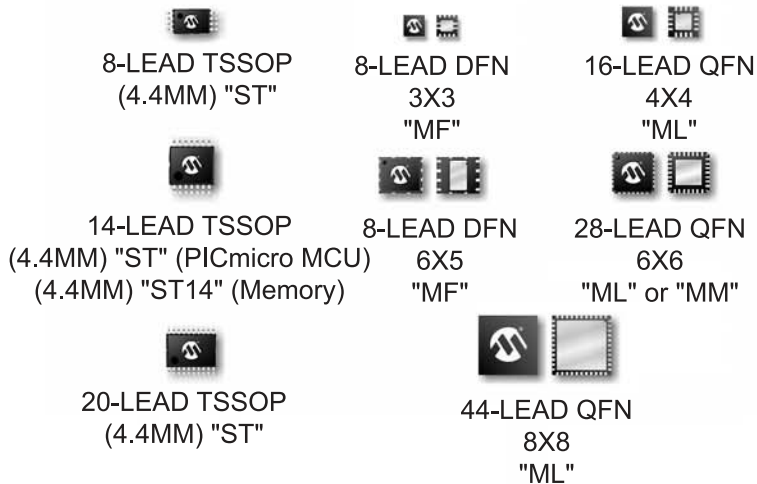

**CHIP SCALE
PACKAGES**



SMALL OUTLINE TRANSISTOR

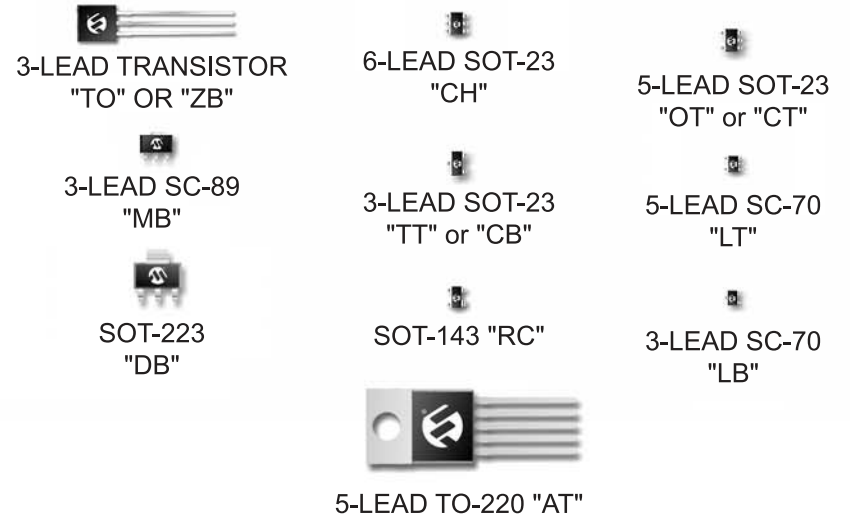

Part Number Suffix Designations

Ordering Information for all Microchip PICmicro®, KEELOC®, RFID, rHCS and Memory Products

XXXXXXXXXX - XX X/XX XXX

	QTP, SQTP or ROM Code; Special Requirements	
	Package:	
	1M = 1000pF COB Module	S = Die in Waffle Pack
	3M = 330pF COB Module	SB = Bumped Die in Waffle Pack
	7M = 2x68pF COB Module (IOA2)	SL = 14-lead Small Outline (150 mil)
	CB = Chip on Board (COB)	SM = 8-lead Small Outline (207 mil)
	CL = Windowed CERQUAD	SN = 8-lead Small Outline (150 mil)
	G = Lead Free	SO = Plastic Small Outline (SOIC) (300 mil)
	JW = Windowed CERDIP	SP = Plastic Skinny DIP
	L = Plastic Leaded Chip Carrier (PLCC)	SS = Plastic Shrink Small Outline (SSOP)
LQ = Plastic Low Quad Flatpack (LQFP)	ST = Thin Shrink Small Outline (TSSOP 4.4 mm)	
MC = Dual Flat-No Leads (DFN) 2x3	ST14 = 14-lead Thin Shrink Small Outline (TSSOP-14)	
MF = Dual Flat - No Leads (DFN)	TO-92 = Transistor Outline	
ML = Quad Flat - No Leads (QFN)	TS = Thin Small Outline (8mm x 20mm)	
MM = Quad Flat - No Leads (DFN)	TT = SOT-23-3 Small Outline Transistor	
MS = Micro Small Outline (MSOP)	VS = Very Small Outline (8mm x 12mm)	
OT = 5-Lead or 6-Lead SOT-23	W = Uncut Wafer	
P = Plastic DIP	WB = Bumped Wafer	
PF = Plastic Thin Quad Flatpack (TQFP 14x14)	WF = Sawed Wafer on Frame	
PQ = Plastic Quad Flatpack (PQFP)	WFB = Bumped, Sawed Wafer on Frame	
PT = Plastic Thin Quad Flatpack (TQFP)	WM = SOT385 Leadless Module	
Process Temperature:		
Blank = 0°C to +70°C		
I (Industrial) = -40°C to +85°C		
E (Extended) = -40°C to +125°C		
Speed:		
-90 = 90 ns	OR	
-10 = 100 ns		
-12 = 120 ns		
-15 = 150 ns		
-17 = 170 ns		
-20 = 200 ns or 20 MIPS		
-25 = 250 ns or 30 MIPS		
-30 = 300 ns		
Option:		
T = Tape and Reel Shipments		
X = Rotated pinout		
Device Type: (Up to 10 digits)		
AA = 1.8V Serial EEPROM	LCE = Low Voltage CMOS EPROM/EEPROM MCU	
C = CMOS EPROM/ROMless MCU	LCR = Low Voltage CMOS ROM MCU	
C = 5V Serial EEPROM	LCS = Low Voltage Security	
CE = CMOS EPROM/EEPROM MCU	LF = Low Voltage FLASH MCU	
CR = CMOS ROM MCU	LV = Low Voltage	
F = Flash MCU	24 = 2-Wire (I ² C)	
FC = High Speed serial EEPROM	25 = SPI	
HC = High Speed	93 = 3-Wire (Microwire)	
HV = High Voltage		
LC = Low Voltage CMOS EPROM MCU		
LC = Low Voltage (2.5V) Serial EEPROM		
Note: Microchip offers a wide variety of lead-free package options. Contact your local sales office for availability or refer to the list on Microchip's web site.		

Crystal Frequency Designator for PICmicro® MCUs

LP = DC to 40 kHz, Low Power Crystal Oscillator
RC = DC to 4 MHz, Resistor/Capacitor Oscillator
XT = DC to 4 MHz, Standard Crystal Resonator Oscillator
HS = High Speed
02 = DC to 20 MHz, High Speed Crystal Oscillator
04 = DC to 2 MHz, XT and RC Oscillator Support
04 = DC to 4 MHz Internal, XT and RC Oscillator Support
08 = DC to 8 MHz, XT and RC Oscillator Support
10 = DC to 200 kHz, LP Oscillator Support
16 = DC to 8 MHz, HS Oscillator Support
20 = DC to 10 MHz, HS Oscillator Support
25 = DC to 16 MHz, XT Oscillator Support
30 = DC to 20 MHz, HS Oscillator Support
33 = DC to 25 MHz, XT Oscillator Support
40 = DC to 30 MHz, HS Oscillator Support
DC to 33 MHz, XT Oscillator Support
DC to 40 MHz, HS Oscillator Support

Pin Count/
Packaging

Part Number Suffix Designations

Ordering Information for all Microchip Analog Products beginning with "TC" (formerly TelCom Semiconductor Products)

TC 7106 A-60 1 C P L 713

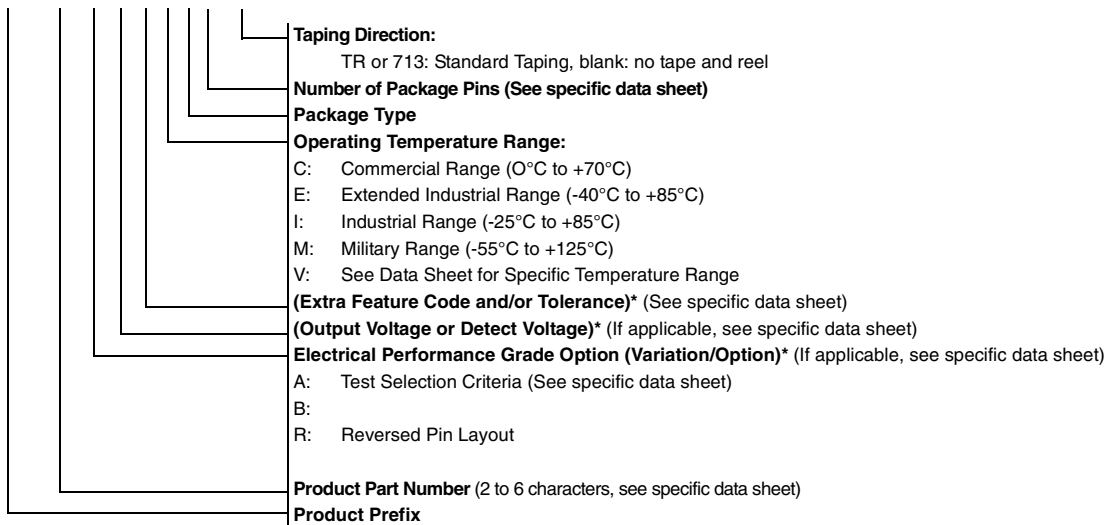

NOTE: (*) Used for voltage regulators and detectors.

Package	Description	# of Pins
AB	TO-220	3
AK	TO-220	7
AT	TO-220	5
AV	TO-220 (Formed)	5
BB	TO-220B	3
CB	SOT-23A	3
CH	SOT-23A	6
CT	SOT-23A	5
DB	SOT-223	3
EB	DDPAK	3
EK	DDPAK	7
ET	DDPAK	5
HA	SOP	8
JA	CDIP (N)	8
JD	CDIP (N)	14
JE	CDIP (N)	16
JG	CDIP (W)	24
JI	CDIP (W)	28
JL	CDIP (W)	40
KU	MQFP	64
KW	MQFP	44
LB	SC-70	3
LI	PLCC	28
LS	PLCC	68
LT	SC-70	5
LW	PLCC	44

Package	Description	# of Pins
MB	SOT-89	3
MF	DFN (3x3)	8
MT	SOT-89	5
NB	SOT-23B	3
OA	SOIC (N)	8
OD	SOIC (N)	14
OE	SOIC (W)	16
OG	SOIC (W)	24
OI	SOIC (W)	28
OR	SOIC (N)	16
PA	PDIP (N)	8
PD	PDIP (N)	14
PE	PDIP (N)	16
PF	PDIP (N)	24
PG	PDIP (W)	24
PI	PDIP (W)	28
PJ	PDIP (W)	28
PL	PDIP (W)	40
QR	QSOP (N)	16
RC	SOT-143	4
SI	SSOP (W)	28
UA	MSOP	8
UN	MSOP	10
VB	DDPAK	3
ZB	TO-92	3
ZM	TO-92	2

Pin Count/
Packaging

MCP xxxxx T - yyy z h / qq

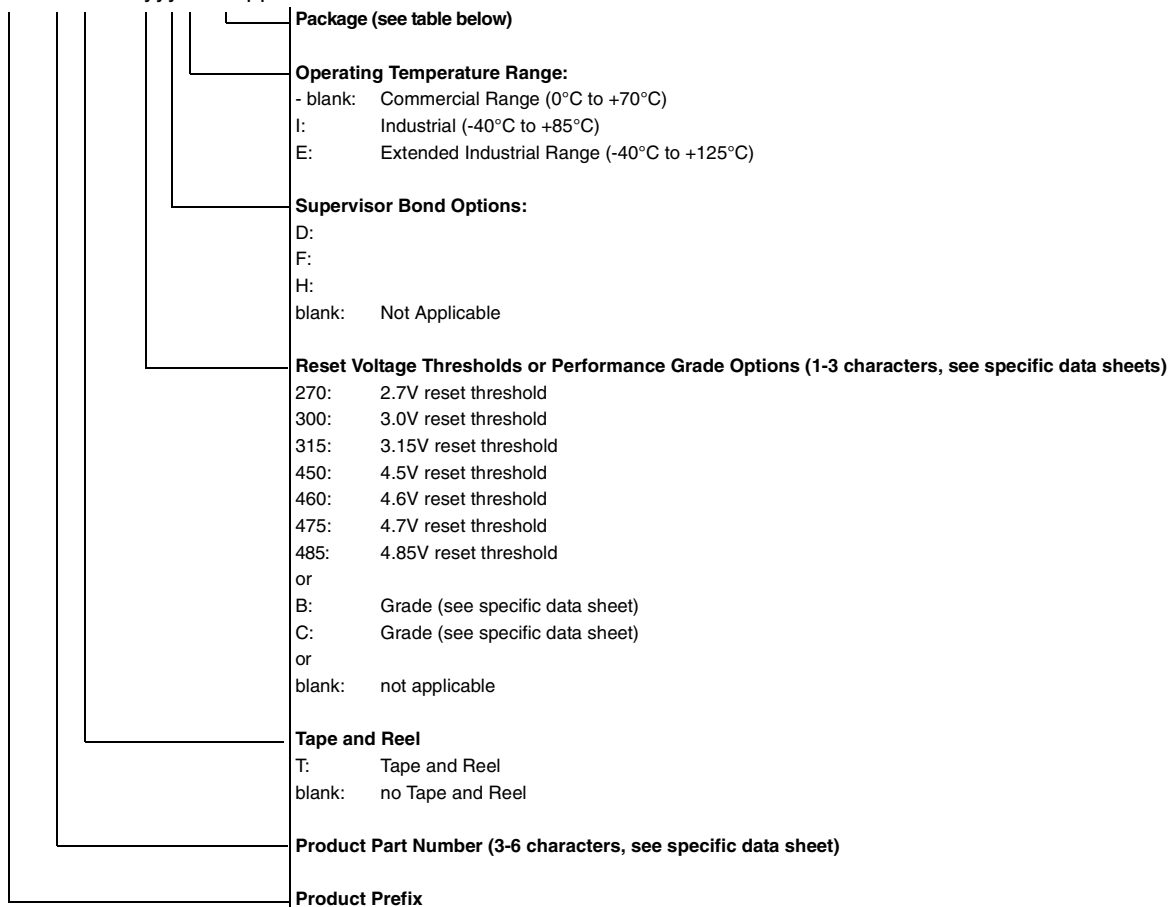

Package	Description	# of Pins	Tube/Bag Qty.	Reel Qty.
TO	TO-92	3	1000	n/a
TT	SOT-23	3	n/a	3000
OT	SOT-23	5	n/a	3000
P	PDIP	8	60	n/a
SN	SOIC	8	100	3300
ST	TSSOP	8	100	2500
MS	MSOP	8	100	2500
MF	DFN (3x3)	8	50	3300
MF	DFN (3x3, 10-Pin)	10	120	3300
ST	TSSOP	14	96	2500
P	PDIP	14	30	n/a
SL	SOIC	14	57	2600
P	PDIP	18	25	n/a
SO	SOIC	18	42	1100
ST	TSSOP	20	74	2500
SS	SSOP	20	67	1600
ML	QFN (6x6)	28	50	1600
ML	QFN (4x4)	16	91	3300

Pin Count/
Packaging

ABBREVIATIONS	
ADC	Analog-to-Digital Converter
ASK	Amplitude Shift Key
AUSART	Addressable USART (RS-232, RS-485)
BOR	Brown-Out Detection/Reset
CAN	Controller Area Network
CAP	Capture
CCP	Capture/Compare/1 PWM output
CRC	Cyclic Redundancy Check
DAC	Digital-to-Analog Converter
3 ϕ	3 Phase PWMs
4 ϕ	4 Phase PWMs
E2	EEPROM (Reprogrammable)
ECAN	Enhanced Controller Area Network
ECCP	Enhanced Capture/Compare/4 PWM outputs with program dead time
EMA	External Memory Addressing
EnhFI	Enhanced Flash: look erase/write cycles, 40 year retention, self-programmable in socket from 2V to 5.5V, ICSP at 5V or 12V; data EE available with up to 1 million erase/write cycles
EUSART	Enhanced USART (RS232, RS485, LIN)
FSK	Frequency Shift Key
I ² C	Inter-integrated Circuit Bus
ICSP TM	In-Circuit Serial Programming TM
ICD	# of In-Circuit Debug Breakpoints
IntOSC	Internal Oscillator
LNA	Low Noise Amplifier
LVD	Low Voltage Detection
LIN XCVR	Local Interconnection Network Transceiver
MI ² C/SPI	Master I ² C/SPI
nW	nanoWatt
OTP	One-Time Programmable
PBOR	Programmable Brown-Out Detection/Reset
PLVD	Programmable Low-Voltage Detection
PSMC	Programmable Switch Mode Controller
PSP	Parallel Slave Port
PSMC	Programmable Switch Mode Controller
PWM	Pulse Width Modulator
ROM-less	External ROM necessary
RSSI	Received Signal Strength Indicator
SLAC	Slope A/D Converter, up to 16 bits
SMB	System Management Bus
SPI	Serial Peripheral Interface
StdFI	Standard Flash: up to 10,000 erase/write cycles, 40 year retention, ICSP capability at 12V
ULPW	Ultra Low Power Wake-up
USART	Universal Synchronous/Asynchronous Receiver/Transmitter
USB	Universal Serial Bus
VREF	Voltage Reference
WDT	Watchdog Timer
\sqrt{P}	Programmable
x12	12-bit Instruction Width
x14	14-bit Instruction Width
x16	16-bit Instruction Width

Microchip Technology's Quality Policy

In order to meet or exceed customer expectations at a reduced cost, we encourage our employees to support continuous improvement, anticipate problems and implement root cause solutions.

Aggregate Approach

Microchip has instituted an "aggregate" approach to understand, align, integrate and unite all company resources. Microchip consciously designed the enterprise as an aggregate system in which company culture, systems, practices, policies and employees work in unison to achieve Microchip's mission and goals. This aggregate system and culture is taught in the Microchip Culture class required for all new hires and taught by Executive Staff members.

The Quality Culture of Microchip is that every organization, business unit and individual owns the quality of their output, whether it is product, process, software or service.

A company must aggressively pursue continuous improvement, employee development, team deployment and statistical techniques to successfully achieve individual accountability of quality.

Continuous Improvement

Microchip promotes a culture of continuous improvement. As stated above, each employee is measured on how they contribute to improvement. Continuous improvement teams are constantly looking to solve problems, allowing us to maximize our value to our customers.

Employee Development and Team Deployment

Every employee has access to a full suite of training. Each employee is measured on Quality and Quantity of work, Teamwork, Continuous Improvement and Customer Satisfaction. Supervisors are measured on how their employees improve and learn. Employees have regular One-on-Ones with their supervisors and open door is a policy that is really practiced.

Statistical Techniques

Microchip uses statistical process techniques in all aspects of our business. Decision-making, experiment definition and process control are a few areas where these techniques are applied. Every manufacturing employee is trained in SPC before they start their job, since they are the people closest to the product quality.

QS-9000 Certification

Microchip Technology's Quality System is based on QS-9000 requirements. QS-9000 is rapidly becoming the standard Quality System for many industries including Semiconductors. All Microchip product facilities and major subcontractors are QS registered. Development Systems and Mountain View products are designed, manufactured and certified to ISO-9001 requirements.

Quality Systems and Reliability Information

Visit www.microchip.com for detailed Quality Systems and Reliability information.

Microchip's Quality System is fully described in the *Microchip Overview, Quality Systems and Customer Interface Systems Handbook* (DS00169) available on our web site.

Sales Listing

AMERICAS

Atlanta	770-640-0034
Boston	978-692-3848
Chicago	630-285-0071
Dallas	972-818-7423
Detroit	248-538-2250
Kokomo	765-864-8360
Los Angeles	949-462-9523
San Jose	650-215-1444
Toronto	905-673-0699

ASIA/PACIFIC

Australia	61-2-9868-6733
China – Beijing	86-10-8528-2100
China – Chengdu	86-28-8676-6200
China – Fuzhou	86-591-8750-3506
China – Hong Kong	852-2401-1200
China – Shanghai	86-21-5407-5533
China – Shenyang	86-24-2334-2829
China – Shenzhen	86-755-8203-2660
China – Shunde	86-757-2839-5507
China – Qingdao	86-532-502-7355
India – Bangalore	91-80-2229-0061
India – New Delhi	91-11-5160-8631
Japan	81-45-471-6166
Korea	82-2-554-7200
Singapore	65-6334-8870
Taiwan – Hsinchu	886-3-572-9526
Taiwan – Kaohsiung	886-7-536-4818
Taiwan – Taipei	886-2-2500-6610

EUROPE

Austria	43-7242-2244-399
Denmark	45-4420-2828
France	33-1-69-53-63-20
Germany	49-89-627-144-0
Italy	39-0331-742611
Netherlands	31-416-690399
United Kingdom	44-118-921-5869



MICROCHIP
www.microchip.com

2355 West Chandler Boulevard • Chandler, Arizona 85224-6199 • (480) 792-7200 • Fax (480) 792-7277

Information subject to change. The Microchip name and logo, the Microchip logo, Accuron, dsPIC, Keeloq, microID, MPLAB, PIC, PICmicro, PICSTART, PRO MATE, PowerSmart, rPIC, and SmartShunt are registered trademarks of Microchip Technology Incorporated in the U.S.A. and other countries. AmpLab, FilterLab, Migratable Memory, MXDEV, MXLAB, PICMASTER, SEEVAL, SmartSensor and The Embedded Control Solutions are registered trademarks of Microchip Technology Incorporated in the U.S.A. Application Maestro, dsPICDEM, dsPICDEM.net, dsPICworks, ECAN, ECONOMONITOR, FanSense, FlexROM, fuzzyLAB, In-Circuit Serial Programming, ICSP ICEPIC, MPASM, MPLIB, MPLINK, MPSIM, PICkit, PICDEM, PICDEM.net, PICLAB, PICtail, PowerCal, PowerInfo, PowerMate, PowerTool, rLab, Select Mode, Smart Serial, SmartTel and Total Endurance are trademarks of Microchip Technology Incorporated in the U.S.A. and other countries.

SQTP is a service mark of Microchip Technology Incorporated in the U.S.A.

All other trademarks mentioned herein are property of their respective companies.

©2005 Microchip Technology Inc. All rights reserved. Printed in the U.S.A. 04/05 DS00148K2