

4800 N

AC axial compact fan



ebm-papst St. Georgen GmbH & Co. KG

Hermann-Papst-Str. 1
D-78112 St. Georgen
Phone +49 (0) 7724 81-0
Fax +49 (0) 7724 81-1309
info2@de.ebmpapst.com
www.ebmpapst.com

Nominal data

Type	4800 N	
Phase		1~
Nominal voltage	VAC	115
Frequency	Hz	60
Speed (rpm)	min ⁻¹	1750
Power consumption	W	9.0
Min. ambient temperature	°C	-10
Max. ambient temperature	°C	75
Air flow	m ³ /h	97
Sound power level	B	4.3
Sound pressure level	dB(A)	32

ml = Max. load · me = Max. efficiency · fa = Free air · cs = Customer specification · ce = Customer equipment
Subject to change



Technical description

Weight	0.550 kg
Dimensions	119 x 119 x 38 mm
Impeller material	Sheet steel, painted black
Housing material	Die-cast aluminum
Airflow direction	Intake over struts
Direction of rotation	Clockwise, viewed toward rotor
Storage	Sintec sleeve bearing
Service life L10 at 40 °C	60000 h
Service life L10 at maximum temperature	27500 h
Cable	2 flat plugs 3.0 x 0.5 mm. Housing with grounding lugs with M4 and UNC thread.
Motor protection	Protected from overload by impedance protection
Approval	VDE, CSA, UL, CE
Option	Versions with reinforced mounting flanges and exposed external leads.



Product drawing

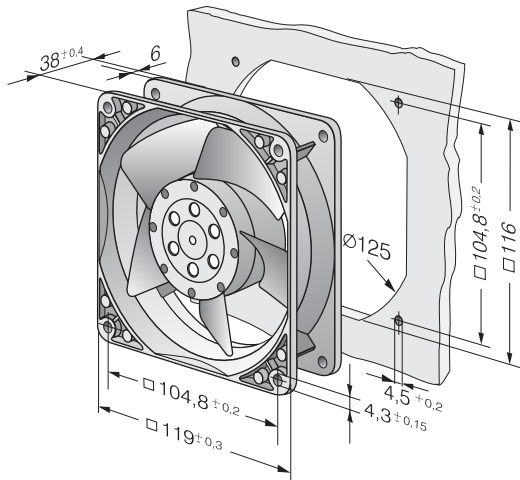

Curves: Air performance

