

Features

- Permanent and Reversible Software Write Protection for the First-half of the Array
 - Software Procedure to Verify Write Protect Status
- Hardware Write Protection for the Entire Array
- Low-voltage and Standard-voltage Operation
 - 1.7 (V_{CC} = 1.7V to 3.6V)
- Internally Organized 256 x 8
- Two-wire Serial Interface
- Schmitt Trigger, Filtered Inputs for Noise Suppression
- Bidirectional Data Transfer Protocol
- 100 kHz (1.7V) and 400 kHz (2.7V and 3.6V) Compatibility
- 16-byte Page Write Modes
- Partial Page Writes Are Allowed
- Self-timed Write Cycle (5 ms max)
- High-reliability
 - Endurance: 1 Million Write Cycles
 - Data Retention: 100 Years
- 8-lead JEDEC SOIC, 8-lead Ultra Thin Mini-MAP (MLP 2x3), 8-lead TSSOP, and 8-ball dBGA2 Packages

Description

The AT34C02B provides 2048 bits of serial electrically-erasable and programmable read only memory (EEPROM) organized as 256 words of 8 bits each. The first-half of the device incorporates a permanent and a reversible software write protection feature while hardware write protection for the entire array is available via an external pin. Once the permanent software write protection is enabled, by sending a special command to the device, it cannot be reversed. However, the reversible software write protection is enabled and can be reversed by sending a special command. The hardware write protection is controlled with the WP pin and can be used to protect the entire array, whether or not the software write protection has been enabled. This allows the user to protect none, first-half, or all of the array depending on the application. The device is optimized for use in many industrial and commercial applications where low-power and low-voltage operations are essential. The AT34C02B is available in space saving 8-lead JEDEC SOIC, 8-lead Ultra Thin Mini-MAP (MLP 2x3), 8-lead TSSOP, and 8-ball dBGA2 packages and is accessed via a Two-wire serial interface. It is available in 1.7V (1.7V to 3.6V).

Table 1. Pin Configurations

| Pin Name | Function |
|----------|--------------------|
| A0 - A2 | Address Inputs |
| SDA | Serial Data |
| SCL | Serial Clock Input |
| WP | Write Protect |

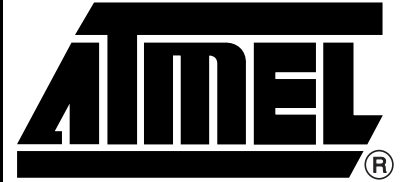
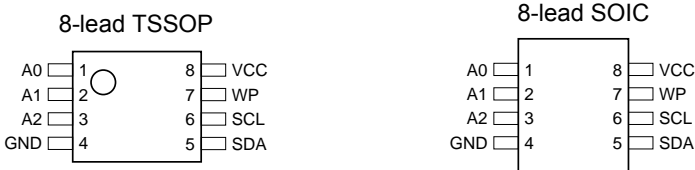
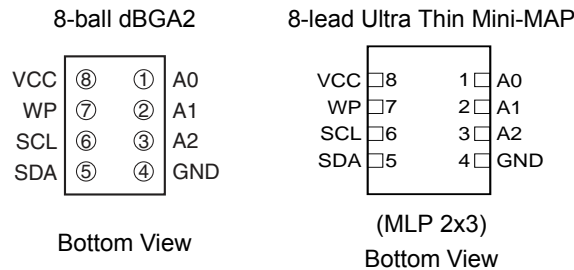

Two-wire Serial EEPROM with Permanent and Reversible Software Write Protect

2K (256 x 8)

AT34C02B

Note: Not recommended for new design; please refer to AT34C02C datasheet.



Absolute Maximum Ratings*

| | |
|--|-----------------|
| Operating Temperature..... | -55°C to +125°C |
| Storage Temperature | -65°C to +150°C |
| Voltage on Any Pin with Respect to Ground | -1.0V to +7.0V |
| Maximum Operating Voltage | 6.25V |
| DC Output Current..... | 5.0 mA |

*NOTICE: Stresses beyond those listed under “Absolute Maximum Ratings” may cause permanent damage to the device. This is a stress rating only and functional operation of the device at these or any other conditions beyond those indicated in the operational sections of this specification is not implied. Exposure to absolute maximum rating conditions for extended periods may affect device reliability.

Figure 1. Block Diagram

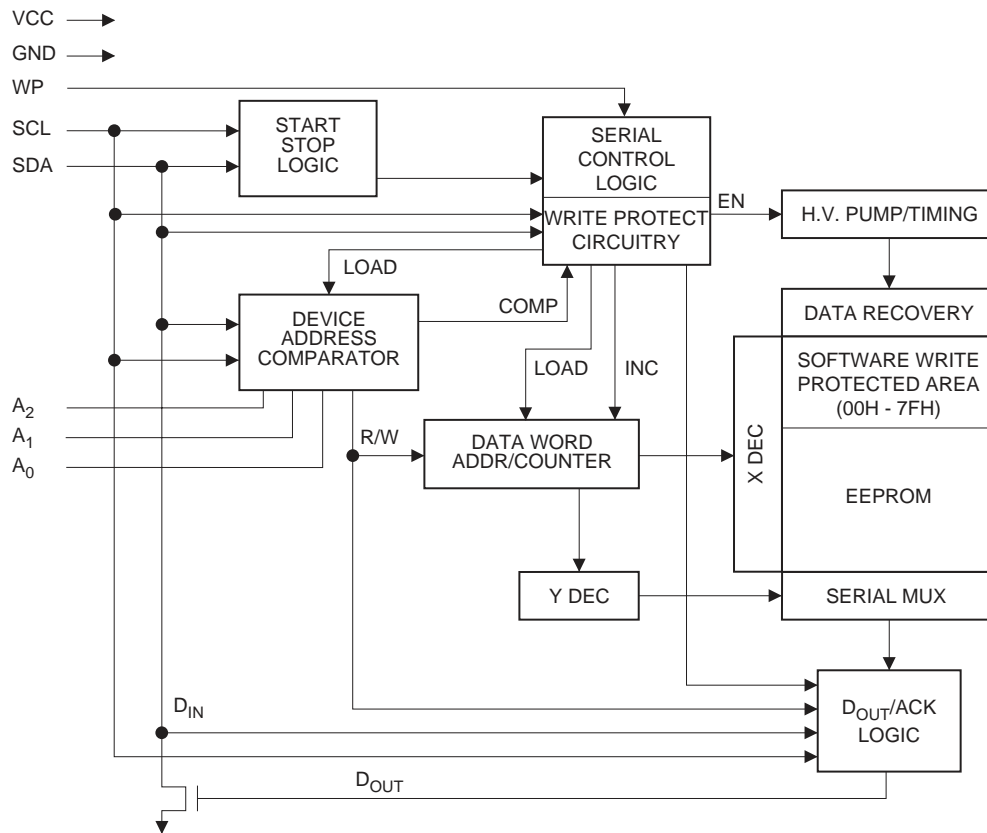

Pin Description

SERIAL CLOCK (SCL): The SCL input is used to positive edge clock data into each EEPROM device and negative edge clock data out of each device.

SERIAL DATA (SDA): The SDA pin is bidirectional for serial data transfer. This pin is open-drain driven and may be wire-ORed with any number of other open-drain or open collector devices.

DEVICE/PAGE ADDRESSES (A2, A1, A0): The A2, A1, and A0 pins are device address inputs that are hardwired (directly to GND or to Vcc) for compatibility with other AT24Cxx devices. When the pins are hardwired, as many as eight 2K devices may be addressed on a single bus system. (Device addressing is discussed in detail under “Device Addressing,” page 9.) A device is selected when a corresponding hardware and software match is true. If these pins are left floating, the A2, A1, and A0 pins will be internally pulled down to GND. However, due to capacitive coupling that may appear during customer applications, Atmel recommends always connecting the address pins to a known state. When using a pull-up resistor, Atmel recommends using 10kΩ or less.

WRITE PROTECT (WP): The write protect input, when connected to GND, allows normal write operations. When WP is connected directly to Vcc, all write operations to the memory are inhibited. If the pin is left floating, the WP pin will be internally pulled down to GND. However, due to capacitive coupling that may appear during customer applications, Atmel recommends always connecting the WP pins to a known state. When using a pull-up resistor, Atmel recommends using 10kΩ or less.

Table 2. AT34C02B Write Protection Modes

| WP Pin Status | Permanent Write Protect Register | Reversible Write Protect Register | Part of the Array Write Protected |
|-----------------|----------------------------------|-----------------------------------|-------------------------------------|
| V _{CC} | – | – | Full Array (2K) |
| GND or Floating | Not Programmed | Not Programmed | Normal Read/Write |
| GND or Floating | Programmed | – | First-Half of Array (1K: 00H - 7FH) |
| GND or Floating | – | Programmed | First-Half of Array (1K: 00H - 7FH) |

Table 3. Pin Capacitance⁽¹⁾

Applicable over recommended operating range from T_A = 25°C, f = 100 kHz, V_{CC} = +1.7V

| Symbol | Test Condition | Max | Units | Conditions |
|------------------|--|-----|-------|-----------------------|
| C _{I/O} | Input/Output Capacitance (SDA) | 8 | pF | V _{I/O} = 0V |
| C _{IN} | Input Capacitance (A ₀ , A ₁ , A ₂ , SCL) | 6 | pF | V _{IN} = 0V |

Note: 1. This parameter is characterized and is not 100% tested.

Table 4. DC Characteristics

Applicable over recommended operating range from: $T_{AI} = -40^{\circ}\text{C}$ to $+85^{\circ}\text{C}$, $V_{CC} = +1.7\text{V}$ to $+3.6\text{V}$, (unless otherwise noted)

| Symbol | Parameter | Test Condition | Min | Typ | Max | Units |
|-----------|---|--------------------------------|---------------------|------|---------------------|---------------|
| V_{CC1} | Supply Voltage | | 1.7 | | 3.6 | V |
| I_{CC} | Supply Current $V_{CC} = 3.6\text{V}$ | READ at 100 kHz | | 0.4 | 1.0 | mA |
| I_{CC} | Supply Current $V_{CC} = 3.6\text{V}$ | WRITE at 100 kHz | | 2.0 | 3.0 | mA |
| I_{SB1} | Standby Current $V_{CC} = 1.7\text{V}$ | $V_{IN} = V_{CC}$ or V_{SS} | | 0.6 | 3.0 | μA |
| I_{SB2} | Standby Current $V_{CC} = 3.6\text{V}$ | $V_{IN} = V_{CC}$ or V_{SS} | | 1.6 | 4.0 | μA |
| I_{LI} | Input Leakage Current | $V_{IN} = V_{CC}$ or V_{SS} | | 0.10 | 3.0 | μA |
| I_{LO} | Output Leakage Current | $V_{OUT} = V_{CC}$ or V_{SS} | | 0.05 | 3.0 | μA |
| V_{IL} | Input Low Level ⁽¹⁾ | | -0.6 | | $V_{CC} \times 0.3$ | V |
| V_{IH} | Input High Level ⁽¹⁾ | | $V_{CC} \times 0.7$ | | $V_{CC} + 0.5$ | V |
| V_{OL2} | Output Low Level $V_{CC} = 3.0\text{V}$ | $I_{OL} = 2.1\text{ mA}$ | | | 0.4 | V |
| V_{OL1} | Output Low Level $V_{CC} = 1.7\text{V}$ | $I_{OL} = 0.15\text{ mA}$ | | | 0.2 | V |

Note: 1. V_{IL} min and V_{IH} max are reference only and are not tested.

Table 5. AC Characteristics

Applicable over recommended operating range from $T_{AI} = -40^{\circ}\text{C}$ to $+85^{\circ}\text{C}$, $V_{CC} = +1.7\text{V}$ to $+3.6\text{V}$, $C_L = 1$ TTL Gate and 100 pF (unless otherwise noted)

| Symbol | Parameter | 1.7V | | 2.7V, 3.6V | | Units |
|--------------------------|--|------|-----|------------|-----|---------------|
| | | Min | Max | Min | Max | |
| f_{SCL} | Clock Frequency, SCL | | 100 | | 400 | kHz |
| t_{LOW} | Clock Pulse Width Low | 4.7 | | 1.2 | | μs |
| t_{HIGH} | Clock Pulse Width High | 4.0 | | 0.6 | | μs |
| t_I | Noise Suppression Time ⁽¹⁾ | | 100 | | 50 | ns |
| t_{AA} | Clock Low to Data Out Valid | 0.1 | 4.5 | 0.1 | 0.9 | μs |
| t_{BUF} | Time the bus must be free before a new transmission can start ⁽¹⁾ | 4.7 | | 1.2 | | μs |
| $t_{HD,STA}$ | Start Hold Time | 4.0 | | 0.6 | | μs |
| $t_{SU,STA}$ | Start Set-up Time | 4.7 | | 0.6 | | μs |
| $t_{HD,DAT}$ | Data In Hold Time | 0 | | 0 | | μs |
| $t_{SU,DAT}$ | Data In Set-up Time | 200 | | 100 | | ns |
| t_R | Inputs Rise Time ⁽¹⁾ | | 1.0 | | 0.3 | μs |
| t_F | Inputs Fall Time ⁽¹⁾ | | 300 | | 300 | ns |
| $t_{SU,STO}$ | Stop Set-up Time | 4.7 | | 0.6 | | μs |
| t_{DH} | Data Out Hold Time | 100 | | 50 | | ns |
| t_{WR} | Write Cycle Time | | 5 | | 5 | ms |
| Endurance ⁽¹⁾ | 25°C, Page Mode | 1M | | 1M | | Write Cycles |

Note: 1. This parameter is characterized and is not 100% tested.



Memory Organization **AT34C02B, 2K Serial EEPROM:** The 2K is internally organized with 16 pages of 16 bytes each. Random word addressing requires a 8-bit data word address.

Device Operation

CLOCK and DATA TRANSITIONS: The SDA pin is normally pulled high with an external device. Data on the SDA pin may change only during SCL low time periods (see Figure 4 on page 7). Data changes during SCL high periods will indicate a start or stop condition as defined below.

START CONDITION: A high-to-low transition of SDA with SCL high is a start condition which must precede any other command (see Figure 5 on page 8).

STOP CONDITION: A low-to-high transition of SDA with SCL high is a stop condition. After a read sequence, the stop command will place the EEPROM in a standby power mode (see Figure 5 on page 8).

ACKNOWLEDGE: All addresses and data words are serially transmitted to and from the EEPROM in 8-bit words. The EEPROM sends a zero to acknowledge that it has received each word. This happens during the ninth clock cycle.

STANDBY MODE: The AT34C02B features a low-power standby mode which is enabled: (a) upon power-up or (b) after the receipt of the STOP bit and the completion of any internal operations.

MEMORY RESET: After an interruption in protocol, power loss or system reset, any Two-wire part can be reset by following these steps:

- (a) Clock up to 9 cycles, (b) look for SDA high in each cycle while SCL is high and then (c) create a start condition.

Figure 2. Bus Timing SCL: Serial Clock SDA: Serial Data I/O

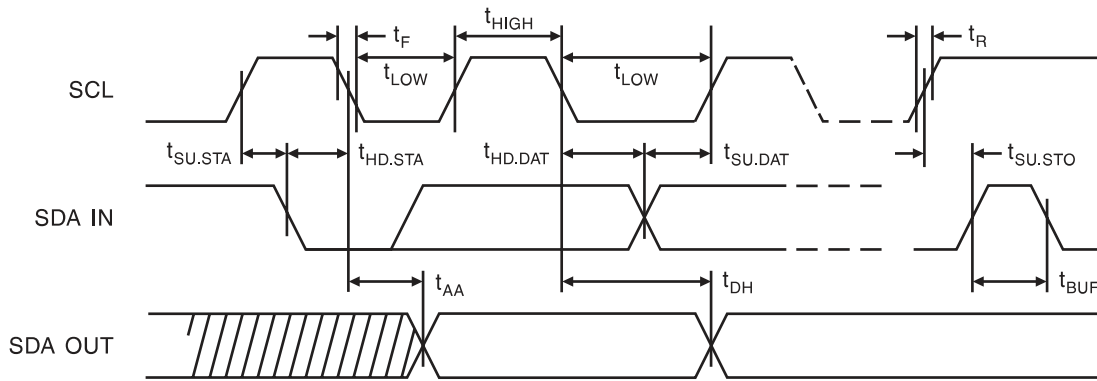
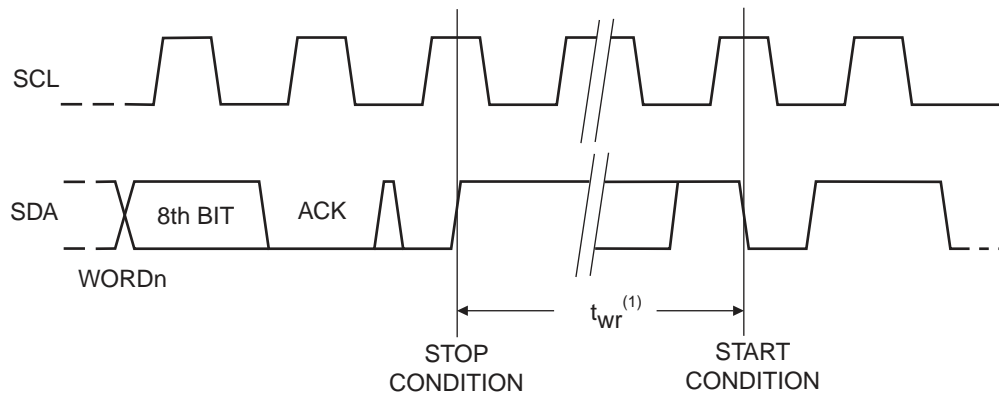

Figure 3. Write Cycle Timing SCL: Serial Clock SDA: Serial Data I/O



Note: 1. The write cycle time t_{wr} is the time from a valid stop condition of a write sequence to the end of the internal clear/write cycle.

Figure 4. Data Validity

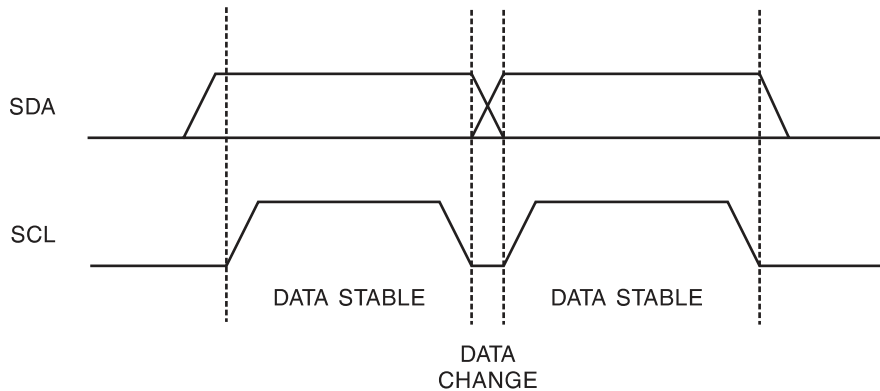

Figure 5. Start and Stop Condition

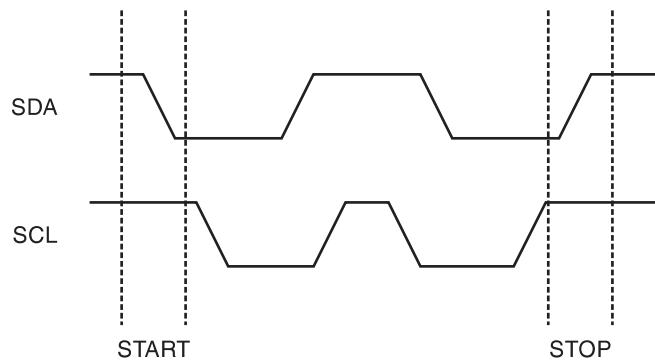
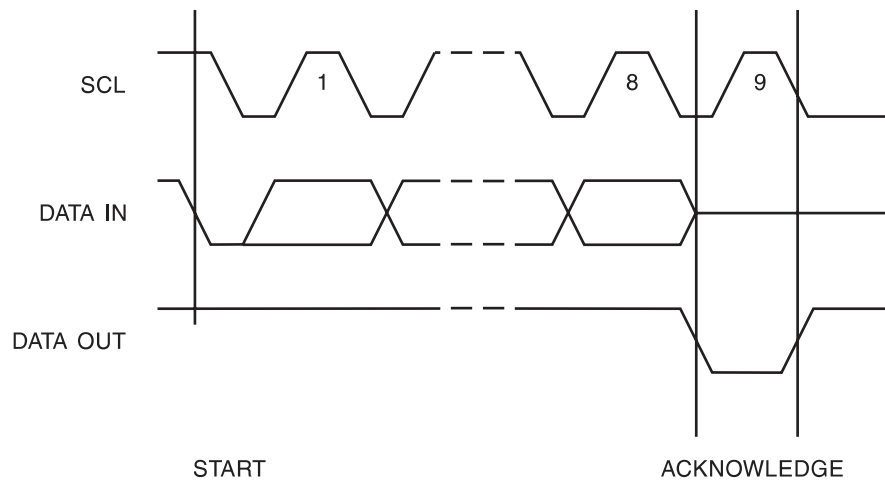

Figure 6. Output Acknowledge



Device Addressing

The 2K EEPROM device requires an 8-bit device address word following a start condition to enable the chip for a read or write operation (see Figure 10 on page 13).

The device address word consists of a mandatory one-zero sequence for the first four most-significant bits (1010) for normal read and write operations and 0110 for writing to the write protect register.

The next 3 bits are the A2, A1 and A0 device address bits for the AT34C02B EEPROM. These 3 bits must compare to their corresponding hard-wired input pins.

The eighth bit of the device address is the read/write operation select bit. A read operation is initiated if this bit is high and a write operation is initiated if this bit is low.

Upon a compare of the device address, the EEPROM will output a zero. If a compare is not made, the chip will return to a standby state. The device will not acknowledge if the write protect register has been programmed and the control code is 0110.

Write Operations

BYTE WRITE: A write operation requires an 8-bit data word address following the device address word and acknowledgment. Upon receipt of this address, the EEPROM will again respond with a zero and then clock in the first 8-bit data word. Following receipt of the 8-bit data word, the EEPROM will output a zero and the addressing device, such as a microcontroller, must terminate the write sequence with a stop condition. At this time the EEPROM enters an internally-timed write cycle, t_{WR} , to the nonvolatile memory. All inputs are disabled during this write cycle and the EEPROM will not respond until the write is complete (see Figure 11 on page 13).

The device will acknowledge a write command, but not write the data, if the software or hardware write protection has been enabled. The write cycle time must be observed even when the write protection is enabled.

PAGE WRITE: The 2K device is capable of 16-byte page write.

A page write is initiated the same as a byte write, but the microcontroller does not send a stop condition after the first data word is clocked in. Instead, after the EEPROM acknowledges receipt of the first data word, the microcontroller can transmit up to fifteen more data words. The EEPROM will respond with a zero after each data word received. The microcontroller must terminate the page write sequence with a stop condition (see Figure 12 on page 14).

The data word address lower four bits are internally incremented following the receipt of each data word. The higher data word address bits are not incremented, retaining the memory page row location. When the word address, internally generated, reaches the page boundary, the following byte is placed at the beginning of the same page. If more than sixteen data words are transmitted to the EEPROM, the data word address will “roll over” and previous data will be overwritten. The address “roll over” during write is from the last byte of the current page to the first byte of the same page.

The device will acknowledge a write command, but not write the data, if the software or hardware write protection has been enabled. The write cycle time must be observed even when the write protection is enabled.

ACKNOWLEDGE POLLING: Once the internally-timed write cycle has started and the EEPROM inputs are disabled, acknowledge polling can be initiated. This involves sending a start condition followed by the device address word. The read/write bit is representative of the operation desired. Only if the internal write cycle has completed will the EEPROM respond with a zero allowing the read or write sequence to continue.

Write Protection

The software write protection, once enabled, write protects only the first-half of the array (00H - 7FH) while the hardware write protection, via the WP pin, is used to protect the entire array.

PERMANENT SOFTWARE WRITE PROTECTION: The software write protection is enabled by sending a command, similar to a normal write command, to the device which programs the permanent write protect register. This must be done with the WP pin low. The write protect register is programmed by sending a write command with the device address of 0110 instead of 1010 with the address and data bit being don't cares (see Figure 7 on page 10). Once the software write protection has been enabled, the device will no longer acknowledge the 0110 control byte. The software write protection cannot be reversed even if the device is powered down. The write cycle time must be observed.

REVERSIBLE SOFTWARE WRITE PROTECTION: The reversible software write protection is enabled by sending a command, similar to a normal write command, to the device which programs the reversible write protect register. This must be done with the WP pin low. The write protect register is programmed by sending a write command 01100010 with pins A2 and A1 tied to ground or don't connect and pin A0 connected to VHV (see Figure 8). The reversible write protection can be reversed by sending a command 01100110 with pin A2 tied to ground or no connect, pin A1 tied to VCC and pin A0 tied to VHV (see Figure 9).

HARDWARE WRITE PROTECTION: The WP pin can be connected to V_{CC} , GND, or left floating. Connecting the WP pin to V_{CC} will write protect the entire array, regardless of whether or not the software write protection has been enabled. The software write protection register cannot be programmed when the WP pin is connected to V_{CC} . If the WP pin is connected to GND or left floating, the write protection mode is determined by the status of the software write protect register.

Figure 7. Setting Permanent Write Protect Register (PSWP)

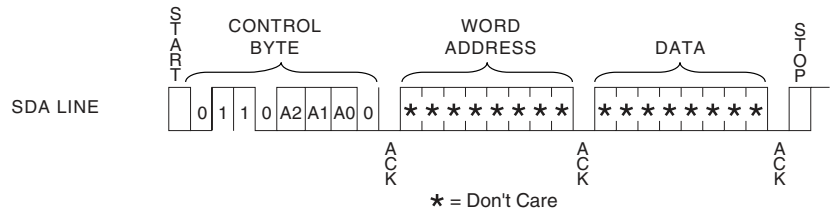

Figure 8. Setting Reversible Write Protect Register (RSWP)

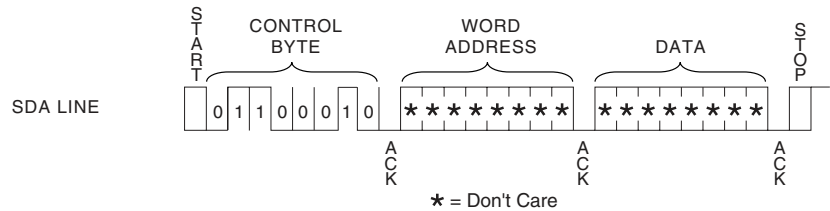

Figure 9. Clearing Reversible Write Protect Register (RSWP)

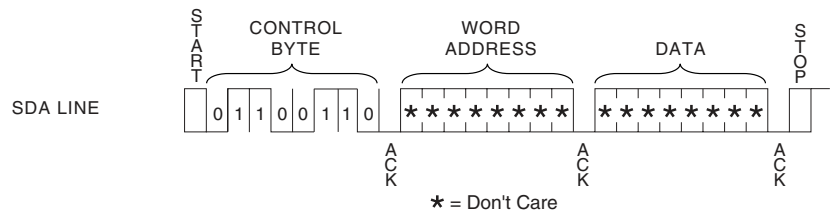

Table 6. Write Protection

| Command | Pin | | | Preamble | | | | | | | RW |
|------------|-----|----|-----|----------|----|----|----|----|----|----|----|
| | A2 | A1 | A0 | B7 | B6 | B5 | B4 | B3 | B2 | B1 | B0 |
| Set PSWP | A2 | A1 | A0 | 0 | 1 | 1 | 0 | A2 | A1 | A0 | 0 |
| Set RSWP | 0 | 0 | VHV | 0 | 1 | 1 | 0 | 0 | 0 | 1 | 0 |
| Clear RSWP | 0 | 1 | VHV | 0 | 1 | 1 | 0 | 0 | 1 | 1 | 0 |

Table 7. VHV

| | Min | Max | Units |
|-----|-----|-----|-------|
| VHV | 7 | 10 | V |

Note: VHV - VCC > 4.8V

Table 8. WP Connected to GND or Floating

| WP Connected to GND or Floating | | | | | |
|---------------------------------|---------|---------------------------------------|--|----------------------------|---|
| Command | R/W Bit | Permanent Write Protect Register PSWP | Reversible Write Protect Register RSWP | Acknowledgment from Device | Action from Device |
| 1010 | R | X | X | ACK | |
| 1010 | W | Programmed | X | ACK | Can write to second Half (80H - FFH) only |
| 1010 | W | X | Programmed | ACK | Can write to second Half (80H - FFH) only |
| 1010 | W | Not Programmed | Not Programmed | ACK | Can write to full array |
| Read PSWP | R | Programmed | X | No ACK | STOP - Indicates permanent write protect register is programmed |
| Read PSWP | R | Not Programmed | X | ACK | Read out data don't care. Indicates PSWP register is not programmed |
| Set PSWP | W | Programmed | X | No ACK | STOP - Indicates permanent write protect register is programmed |
| Set PSWP | W | Not Programmed | X | ACK | Program permanent write protect register (irreversible) |
| Read RSWP | R | X | Programmed | No ACK | STOP - Indicates reversible write protect register is programmed |
| Read RSWP | R | X | Not Programmed | ACK | Read out data don't care. Indicates RSWP register is not programmed |
| Set RSWP | W | X | Programmed | No ACK | STOP - Indicates reversible write protect register is programmed |
| Set RSWP | W | X | Not Programmed | ACK | Program reversible write protect register (reversible) |
| Clear RSWP | W | Programmed | X | No ACK | STOP - Indicates permanent write protect register is programmed |
| Clear RSWP | W | Not Programmed | X | ACK | Clear (unprogram) reversible write protect register (reversible) |

Table 9. WP Connected to Vcc

| WP Connected to Vcc | | | | | |
|---------------------|---------|---------------------------------------|--|----------------------------|---|
| Command | R/W Bit | Permanent Write Protect Register PSWP | Reversible Write Protect Register RSWP | Acknowledgment from Device | Action from Device |
| 1010 | R | X | X | ACK | Read array |
| 1010 | W | X | X | ACK | Device Write Protect |
| Read PSWP | R | Programmed | X | No ACK | STOP - Indicates permanent write protect register is programmed |
| Read PSWP | R | Not Programmed | X | ACK | Read out data don't care. Indicates PSWP register is not programmed |
| Set PSWP | W | Programmed | X | No ACK | STOP - Indicates permanent write protect register is programmed |
| Set PSWP | W | Not Programmed | X | ACK | Cannot program write protect registers |
| Read RSWP | R | X | Programmed | No ACK | STOP - Indicates reversible write protect register is programmed |
| Read RSWP | R | X | Not Programmed | ACK | Read out data don't care. Indicates RSWP register is not programmed |
| Set RSWP | W | X | Programmed | No ACK | STOP - Indicates reversible write protect register is programmed |
| Set RSWP | W | X | Not Programmed | ACK | Cannot program write protect registers |
| Clear RSWP | W | Programmed | X | No ACK | STOP - Indicates permanent write protect register is programmed |
| Clear RSWP | W | Not Programmed | X | ACK | Cannot write to write protect registers |

Read Operations

Read operations are initiated the same way as write operations with the exception that the read/write select bit in the device address word is set to one. There are three read operations: current address read, random address read and sequential read.

CURRENT ADDRESS READ: The internal data word address counter maintains the last address accessed during the last read or write operation, incremented by one. This address stays valid between operations as long as the chip power is maintained. The address “roll over” during read is from the last byte of the last memory page to the first byte of the first page.

Once the device address with the read/write select bit set to one is clocked in and acknowledged by the EEPROM, the current address data word is serially clocked out. To end the command, the microcontroller does not respond with an input zero but does generate a following stop condition (see Figure 13 on page 14).

RANDOM READ: A random read requires a “dummy” byte write sequence to load in the data word address. Once the device address word and data word address are clocked in and acknowledged by the EEPROM, the microcontroller must generate another start condition. The microcontroller now initiates a current address read by sending a device address with the read/write select bit high. The EEPROM acknowledges the device address and serially clocks out the data word. To end the command, the microcontroller

does not respond with a zero but does generate a following stop condition (see Figure 14 on page 14).

SEQUENTIAL READ: Sequential reads are initiated by either a current address read or a random address read. After the microcontroller receives a data word, it responds with an acknowledge. As long as the EEPROM receives an acknowledge, it will continue to increment the data word address and serially clock out sequential data words. When the memory address limit is reached, the data word address will “roll over” and the sequential read will continue. The sequential read operation is terminated when the microcontroller does not respond with a zero but does generate a following stop condition (see Figure 15 on page 14).

PERMANENT WRITE PROTECT REGISTER (PSWP) STATUS: To find out if the register has been programmed, the same procedure is used as to program the register except that the R/W bit is set to 1. If the device sends an acknowledge, then the permanent write protect register has not been programmed. Otherwise, it has been programmed and the device is permanently write protected at the first half of the array.

Table 10. PSWP Status

| Command | Pin | | | Preamble | | | | | | | RW |
|-----------|-----|----|----|----------|----|----|----|----|----|----|----|
| | A2 | A1 | A0 | B7 | B6 | B5 | B4 | B3 | B2 | B1 | B0 |
| Read PSWP | A2 | A1 | A0 | 0 | 1 | 1 | 0 | A2 | A1 | A0 | 1 |

REVERSIBLE WRITE PROTECT REGISTER(RSWP) STATUS: To find out if the register has been programmed, the same procedure is used as to program the register except that the R/W bit is set to 1. If the sends an device acknowledge, then the reversible write protect register has not been programmed. Otherwise, it has been programmed and the device is write protected (reversible) at the first half of the array.

Figure 10. Device Address

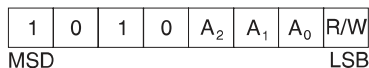

Figure 11. Byte Write

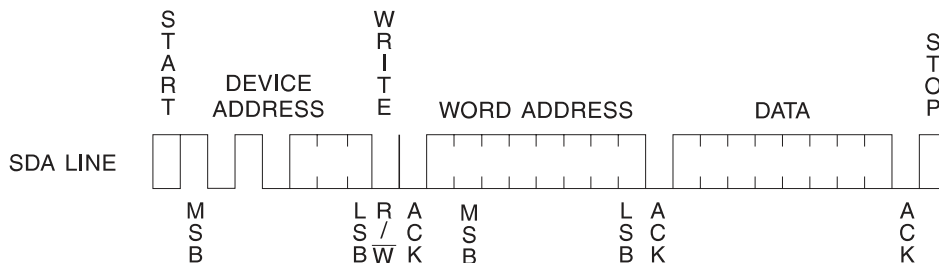

Figure 12. Page Write

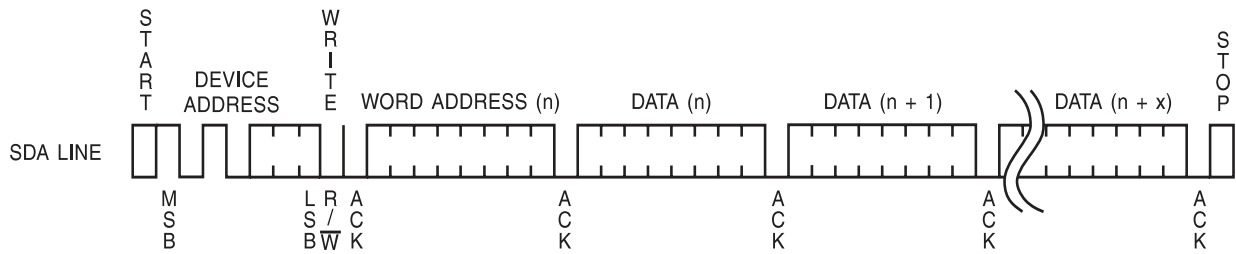

Figure 13. Current Address Read

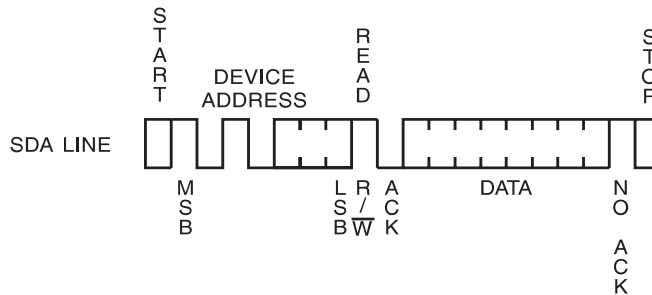

Figure 14. Random Read

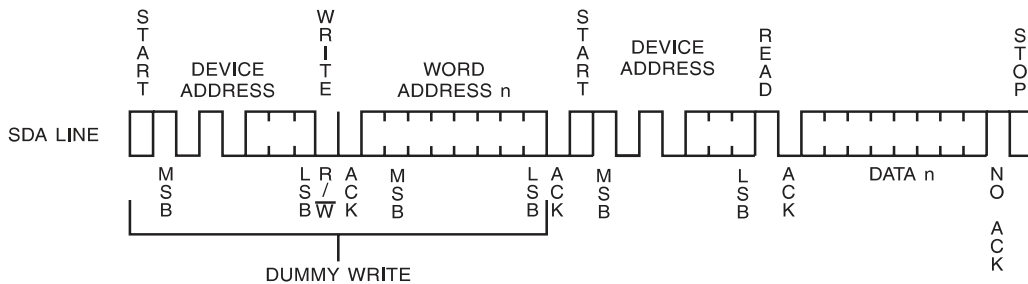
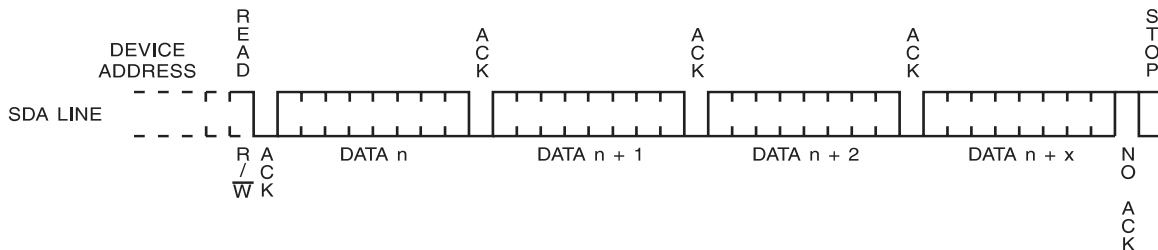

Figure 15. Sequential Read



AT34C02B Ordering Information⁽¹⁾

| Ordering Code | Package | Operation Range |
|------------------------------------|---------|--|
| AT34C02BN-10SU-1.7 ⁽²⁾ | 8S1 | Lead-free/Halogen-free/ Industrial Temperature (-40°C to 85°C) |
| AT34C02B-10TU-1.7 ⁽²⁾ | 8A2 | |
| AT34C02BY6-10YH-1.7 ⁽³⁾ | 8Y6 | |
| AT34C02BU3-10UU-1.7 ⁽²⁾ | 8U3-1 | |

- Notes:
1. Not Recommended for new design; Please refer to AT34C02C datasheet.
 2. "U" designates Green package + RoHS compliant.
 3. "H" designates Green package + RoHS compliant, with NiPdAu Lead Finish.

| Package Type | |
|--------------|--|
| 8S1 | 8-lead, 0.150" Wide, Plastic Gull Wing Small Outline Package (JEDEC SOIC) |
| 8A2 | 8-lead, 0.170" Wide, Thin Shrink Small Outline Package (TSSOP) |
| 8Y6 | 8-lead, 2.00 mm x 3.00 mm Body, 0.50 mm Pitch, Ultra Thin Mini-MAP, Dual No Lead Package (DFN), (MLP 2x3 mm) |
| 8U3-1 | 8-ball, die Ball Grid Array Package (dBGAA2) |
| Options | |
| -1.7 | Low Voltage (1.7V to 3.6V) |

Packaging Information

8S1 – JEDEC SOIC

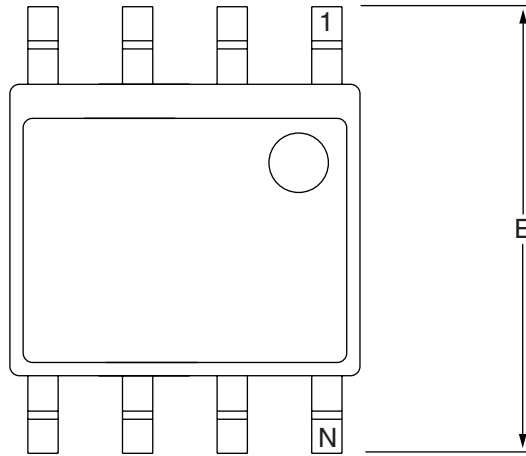

Top View

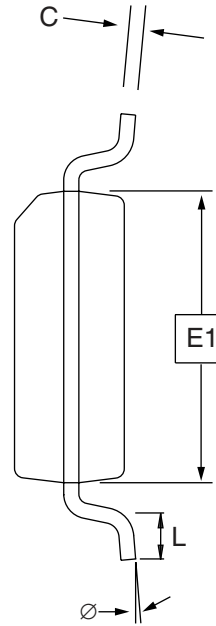

End View

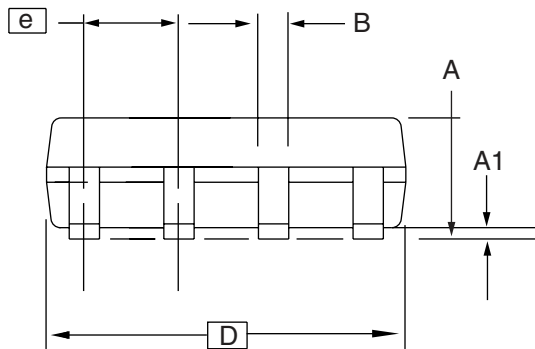

Side View

COMMON DIMENSIONS
(Unit of Measure = mm)

| SYMBOL | MIN | NOM | MAX | NOTE |
|--------|----------|-----|------|------|
| A | 1.35 | – | 1.75 | |
| A1 | 0.10 | – | 0.25 | |
| b | 0.31 | – | 0.51 | |
| C | 0.17 | – | 0.25 | |
| D | 4.80 | – | 5.00 | |
| E1 | 3.81 | – | 3.99 | |
| E | 5.79 | – | 6.20 | |
| e | 1.27 BSC | | | |
| L | 0.40 | – | 1.27 | |
| ∅ | 0° | – | 8° | |

Note: These drawings are for general information only. Refer to JEDEC Drawing MS-012, Variation AA for proper dimensions, tolerances, datums, etc.

10/7/03



1150 E. Cheyenne Mtn. Blvd.
Colorado Springs, CO 80906

TITLE
8S1, 8-lead (0.150" Wide Body), Plastic Gull Wing
Small Outline (JEDEC SOIC)

DRAWING NO.
8S1

REV.
B

8A2 – TSSOP

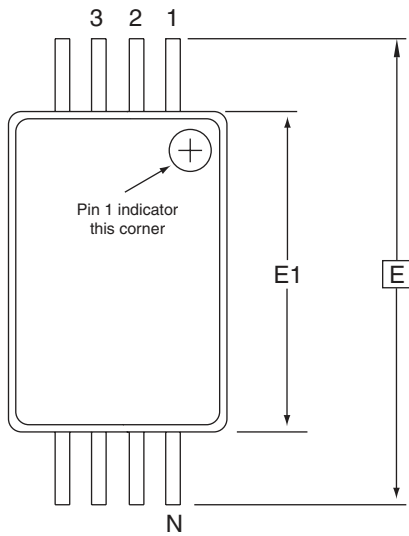

Top View

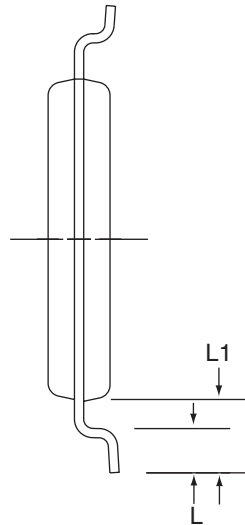

End View

COMMON DIMENSIONS
(Unit of Measure = mm)

| SYMBOL | MIN | NOM | MAX | NOTE |
|--------|----------|------|------|------|
| D | 2.90 | 3.00 | 3.10 | 2, 5 |
| E | 6.40 BSC | | | |
| E1 | 4.30 | 4.40 | 4.50 | 3, 5 |
| A | - | - | 1.20 | |
| A2 | 0.80 | 1.00 | 1.05 | |
| b | 0.19 | - | 0.30 | 4 |
| e | 0.65 BSC | | | |
| L | 0.45 | 0.60 | 0.75 | |
| L1 | 1.00 REF | | | |

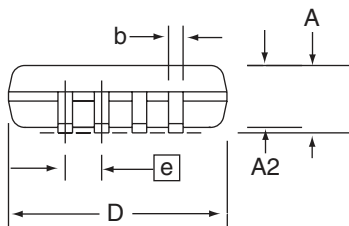

Side View

- Notes:
1. This drawing is for general information only. Refer to JEDEC Drawing MO-153, Variation AA, for proper dimensions, tolerances, datums, etc.
 2. Dimension D does not include mold Flash, protrusions or gate burrs. Mold Flash, protrusions and gate burrs shall not exceed 0.15 mm (0.006 in) per side.
 3. Dimension E1 does not include inter-lead Flash or protrusions. Inter-lead Flash and protrusions shall not exceed 0.25 mm (0.010 in) per side.
 4. Dimension b does not include Dambar protrusion. Allowable Dambar protrusion shall be 0.08 mm total in excess of the b dimension at maximum material condition. Dambar cannot be located on the lower radius of the foot. Minimum space between protrusion and adjacent lead is 0.07 mm.
 5. Dimension D and E1 to be determined at Datum Plane H.

5/30/02



2325 Orchard Parkway
San Jose, CA 95131

TITLE
8A2, 8-lead, 4.4 mm Body, Plastic
Thin Shrink Small Outline Package (TSSOP)

DRAWING NO.
8A2

REV.
B



8Y6 – Mini-MAP

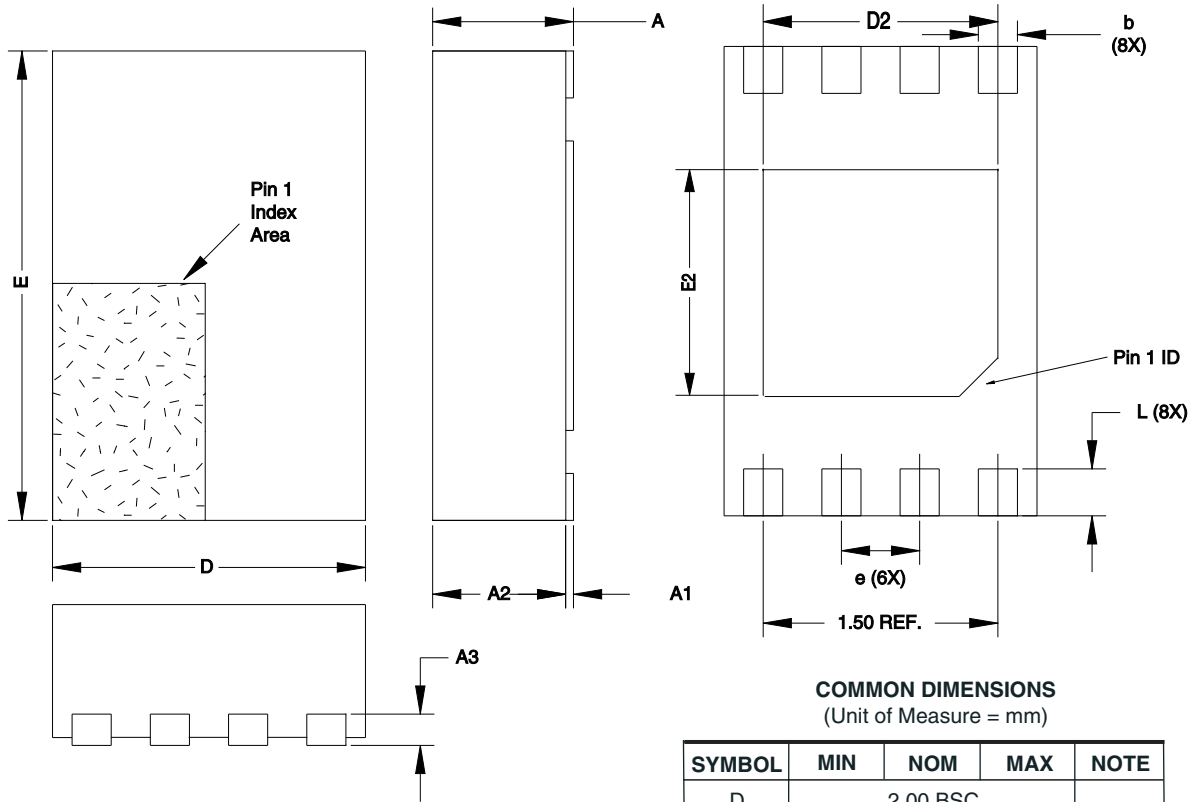

COMMON DIMENSIONS
(Unit of Measure = mm)

| SYMBOL | MIN | NOM | MAX | NOTE |
|--------|----------|------|------|------|
| D | 2.00 BSC | | | |
| E | 3.00 BSC | | | |
| D2 | 1.40 | 1.50 | 1.60 | |
| E2 | - | - | 1.40 | |
| A | - | - | 0.60 | |
| A1 | 0.0 | 0.02 | 0.05 | |
| A2 | - | - | 0.55 | |
| A3 | 0.20 REF | | | |
| L | 0.20 | 0.30 | 0.40 | |
| e | 0.50 BSC | | | |
| b | 0.20 | 0.25 | 0.30 | 2 |

- Notes:
1. This drawing is for general information only. Refer to JEDEC Drawing MO-229, for proper dimensions, tolerances, datums, etc.
 2. Dimension b applies to metallized terminal and is measured between 0.15 mm and 0.30 mm from the terminal tip. If the terminal has the optional radius on the other end of the terminal, the dimension should not be measured in that radius area.

8/26/05



2325 Orchard Parkway
San Jose, CA 95131

TITLE

8Y6, 8-lead 2.0 x 3.0 mm Body, 0.50 mm Pitch, Ultra Thin Mini-Map, Dual No Lead Package (DFN) ,(MLP 2x3)

DRAWING NO.

8Y6

REV.

C

8U3-1 – dBGA2

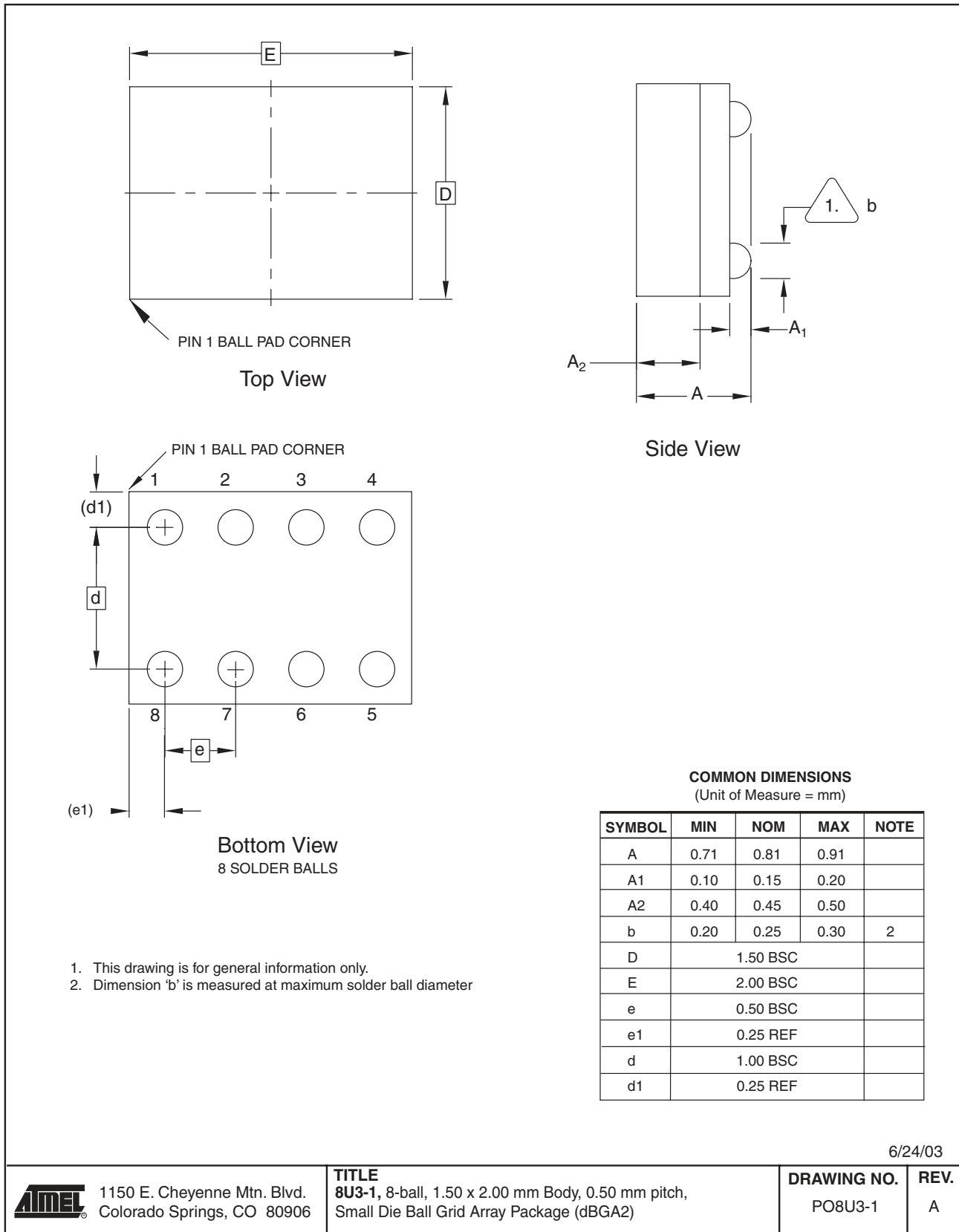



Revision History

| Doc. Rev. | Date | Comments |
|-----------|--------|--|
| 3417E | 1/2007 | Revision History Implemented. Pg 1: Added note: Not Recommended for new design; Please refer to AT34C02C datasheet. |



Atmel Corporation

2325 Orchard Parkway
San Jose, CA 95131, USA
Tel: 1(408) 441-0311
Fax: 1(408) 487-2600

Regional Headquarters

Europe

Atmel Sarl
Route des Arsenalux 41
Case Postale 80
CH-1705 Fribourg
Switzerland
Tel: (41) 26-426-5555
Fax: (41) 26-426-5500

Asia

Room 1219
Chinachem Golden Plaza
77 Mody Road Tsimshatsui
East Kowloon
Hong Kong
Tel: (852) 2721-9778
Fax: (852) 2722-1369

Japan

9F, Tonetsu Shinkawa Bldg.
1-24-8 Shinkawa
Chuo-ku, Tokyo 104-0033
Japan
Tel: (81) 3-3523-3551
Fax: (81) 3-3523-7581

Atmel Operations

Memory

2325 Orchard Parkway
San Jose, CA 95131, USA
Tel: 1(408) 441-0311
Fax: 1(408) 436-4314

Microcontrollers

2325 Orchard Parkway
San Jose, CA 95131, USA
Tel: 1(408) 441-0311
Fax: 1(408) 436-4314

La Chantrerie
BP 70602
44306 Nantes Cedex 3, France
Tel: (33) 2-40-18-18-18
Fax: (33) 2-40-18-19-60

ASIC/ASSP/Smart Cards

Zone Industrielle
13106 Rousset Cedex, France
Tel: (33) 4-42-53-60-00
Fax: (33) 4-42-53-60-01

1150 East Cheyenne Mtn. Blvd.
Colorado Springs, CO 80906, USA
Tel: 1(719) 576-3300
Fax: 1(719) 540-1759

Scottish Enterprise Technology Park
Maxwell Building
East Kilbride G75 0QR, Scotland
Tel: (44) 1355-803-000
Fax: (44) 1355-242-743

RF/Automotive

Theresienstrasse 2
Postfach 3535
74025 Heilbronn, Germany
Tel: (49) 71-31-67-0
Fax: (49) 71-31-67-2340

1150 East Cheyenne Mtn. Blvd.
Colorado Springs, CO 80906, USA
Tel: 1(719) 576-3300
Fax: 1(719) 540-1759

Biometrics/Imaging/Hi-Rel MPU/ High Speed Converters/RF Datacom

Avenue de Rochepleine
BP 123
38521 Saint-Egreve Cedex, France
Tel: (33) 4-76-58-30-00
Fax: (33) 4-76-58-34-80

Literature Requests

www.atmel.com/literature

Disclaimer: The information in this document is provided in connection with Atmel products. No license, express or implied, by estoppel or otherwise, to any intellectual property right is granted by this document or in connection with the sale of Atmel products. **EXCEPT AS SET FORTH IN ATMEL'S TERMS AND CONDITIONS OF SALE LOCATED ON ATMEL'S WEB SITE, ATMEL ASSUMES NO LIABILITY WHATSOEVER AND DISCLAIMS ANY EXPRESS, IMPLIED OR STATUTORY WARRANTY RELATING TO ITS PRODUCTS INCLUDING, BUT NOT LIMITED TO, THE IMPLIED WARRANTY OF MERCHANTABILITY, FITNESS FOR A PARTICULAR PURPOSE, OR NON-INFRINGEMENT. IN NO EVENT SHALL ATMEL BE LIABLE FOR ANY DIRECT, INDIRECT, CONSEQUENTIAL, PUNITIVE, SPECIAL OR INCIDENTAL DAMAGES (INCLUDING, WITHOUT LIMITATION, DAMAGES FOR LOSS OF PROFITS, BUSINESS INTERRUPTION, OR LOSS OF INFORMATION) ARISING OUT OF THE USE OR INABILITY TO USE THIS DOCUMENT, EVEN IF ATMEL HAS BEEN ADVISED OF THE POSSIBILITY OF SUCH DAMAGES.** Atmel makes no representations or warranties with respect to the accuracy or completeness of the contents of this document and reserves the right to make changes to specifications and product descriptions at any time without notice. Atmel does not make any commitment to update the information contained herein. Unless specifically provided otherwise, Atmel products are not suitable for, and shall not be used in, automotive applications. Atmel's products are not intended, authorized, or warranted for use as components in applications intended to support or sustain life.

©2007 Atmel Corporation. All rights reserved. Atmel®, logo and combinations thereof, Everywhere You Are® and others, are registered trademarks or trademarks of Atmel Corporation or its subsidiaries. Other terms and product names may be trademarks of others.



Printed on recycled paper.

3417E-SEEPR-1/07