

# 1-Watt SMD 6x6mm

With Dome Lens

## OVSPxBCR44 Series

- Robust energy-efficient design with long operating life
- Low thermal resistance
- Medium beam angle
- High luminous intensity

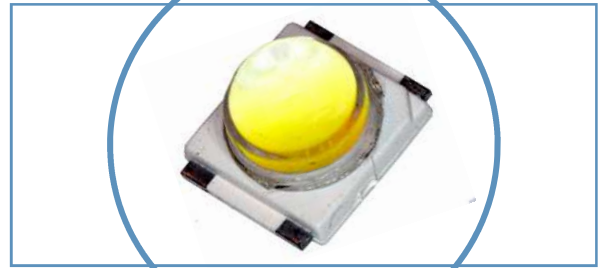

## Applications

- Automotive interior lighting
- Architectural indoor and outdoor lighting
- Electronic signs and signals

Part Number	Beam Angle	Emitted Color	Typ. Dominant Wavelength (nm)	Typ. Luminous Intensity (mcd)	Lens Color
OVSPBBCR44	45°	Blue	460	18,000	Clear
OVSPGBCR44	40°	Green	528	67,500	
OVSPRBCR44	40°	Red	625	56,000	
OVSPW1BCR44	70°	White	N/A	54,000	
OVSPYBCR44	40°	Yellow	591	45,000	

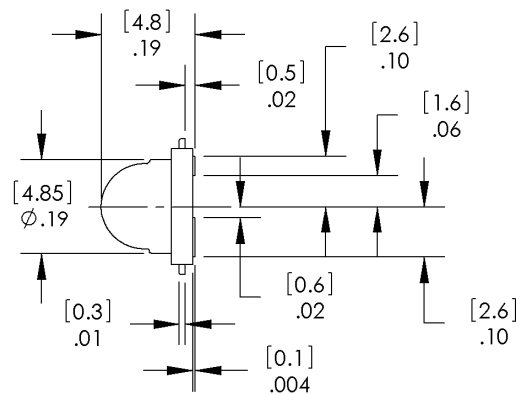
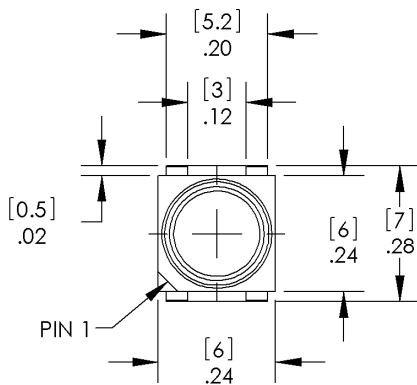

DIMENSIONS ARE IN INCHES [MM]  
GENERAL TOLERANCES ±.008 [0.20]

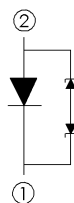

Blue

Pin 1	Pin 2
Cathode	Anode

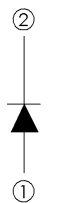

Green, Red, Yellow

Pin 1	Pin 2
Anode	Cathode



White



**DO NOT LOOK DIRECTLY AT LED WITH UNSHIELDED EYES OR DAMAGE TO RETINA MAY OCCUR.**

OPTEK reserves the right to make changes at any time in order to improve design and to supply the best product possible.

# 1-Watt SMD 6x6mm Dome Lens

## OVSPxBCR44 Series



### Absolute Maximum Ratings ( $T_A = 25^\circ\text{C}$ unless otherwise noted)

Storage Temperature Range		-40 ~ +100 °C
Operating Temperature Range		-40 ~ +100 °C
Reverse Voltage	Blue, White	Not designed for reverse bias
	Green	5 V
	Red, Yellow	12V
Continuous Forward Current	Blue, Green, White	350 mA
	Red, Yellow	400 mA
Peak Forward Current (10% Duty Cycle, 1 kHz)	Blue, Green	1000 mA
	Red, Yellow, White	500 mA
Power Dissipation		1200 mW
LED Junction Temperature	Blue, Green	120°C
	Red, Yellow, White	125°C
Electrostatic Discharge Classification (JEDEC-JESD22-A114F)		Class 2
Moisture Sensitivity Level (IPC/JEDEC J-STD-020C)		2a / 672 Hrs
Lead Soldering Temperature (3 mm from the base of the epoxy bulb)		260° C / 5 seconds

### Electrical Characteristics ( $T_A = 25^\circ\text{C}$ unless otherwise noted)

SYMBOL	PARAMETER	COLOR	MIN	TYP	MAX	UNITS	CONDITIONS
$I_V$	Luminous Intensity	Blue	11,250	18,000	22,400	mcd	$I_F = 350\text{ mA}$
		Green	45,000	67,500	90,000		
		Red	35,500	56,000	71,500		$I_F = 400\text{ mA}$
		Yellow	35,500	45,000	56,000		
$V_F$	Forward Voltage	Blue, Green	3.0	3.6	4.0	V	$I_F = 350\text{ mA}$
		Red, Yellow	2.2	2.5	2.8		$I_F = 400\text{ mA}$
$\lambda_D$	Dominant Wavelength	Blue	455	460	465	nm	$I_F = 350\text{ mA}$
		Green	520	528	535		
		Red	620	625	630		$I_F = 400\text{ mA}$
		Yellow	585	591	597		
$2\Theta_{1/2}$	50% Power Angle	Blue	----	45	----	deg	
		Green		40			
		Red		40			
		Yellow		40			

### Electrical Characteristics—White ( $I_F = 350\text{ mA}$ , $T_J = 25^\circ\text{C}$ )

SYMBOL	PARAMETER	MIN	TYP	MAX	UNITS
$V_F$	Forward Voltage	3.0	3.5	4.0	V
$\Phi$	Luminous Flux	----	62	----	lm
$I_V$	Luminous Intensity	45,000	56,000	71,500	mcd
$2\Theta_{1/2}$	50% Power Angle	----	70	----	deg

OPTEK reserves the right to make changes at any time in order to improve design and to supply the best product possible.

# 1-Watt SMD 6x6mm Dome Lens

## OVSPxBCR44 Series



### Standard Bins

LEDs are sorted to the luminous intensity ( $I_v$ ) and dominant wavelength (nm) codes listed below. Each reel consists of a single intensity code and a single color code. Orders are filled utilizing all of the intensity codes and color codes listed in the following tables. Optek will not accept orders for single intensity codes or single color codes.

Luminous Intensity ( $I_v$ ) @ 400mA

Red: OVSPRBCR44		
Code	Min (mcd)	Max (mcd)
AH	35,500	45,000
AJ	45,000	56,000
AK	56,000	71,500
Yellow: OVSPYBCR44		
Code	Min (mcd)	Max (mcd)
AH	35,500	45,000
AJ	45,000	56,000
AK	56,000	71,500

Luminous Intensity ( $I_v$ ) @ 350mA

Blue: OVSPBBCR44		
Code	Min (mcd)	Max (mcd)
AC	11,250	14,000
AD	14,000	18,000
AE	18,000	22,400
Green: OVSPGBCR44		
Code	Min (mcd)	Max (mcd)
AJ	45,000	56,000
AK	56,000	71,500
AL	71,500	90,000

Dominant Wavelength (nm)

Red: OVSPRBCR44	
Full	620 - 630 nm
Yellow: OVSPYBCR44	
A	585 - 588 nm
B	588 - 591 nm
C	591 - 594 nm
D	594 - 597 nm

Blue: OVSPBBCR44	
A	455 - 460 nm
B	460 - 465 nm
Green: OVSPGBCR44	
AO	520 - 525 nm
A	525 - 530 nm
B	530 - 535 nm

OPTEK reserves the right to make changes at any time in order to improve design and to supply the best product possible.

# 1-Watt SMD 6x6mm Dome Lens OVSPxBCR44 Series



## Standard Bins

LEDs are sorted to the luminous intensity ( $I_v$ ) and CCT codes listed below. Each reel consists of a single intensity code and a single CCT code. Orders are filled utilizing all of the intensity codes and CCT codes listed in the following tables. Optek will not accept orders for single intensity codes or single CCT codes.

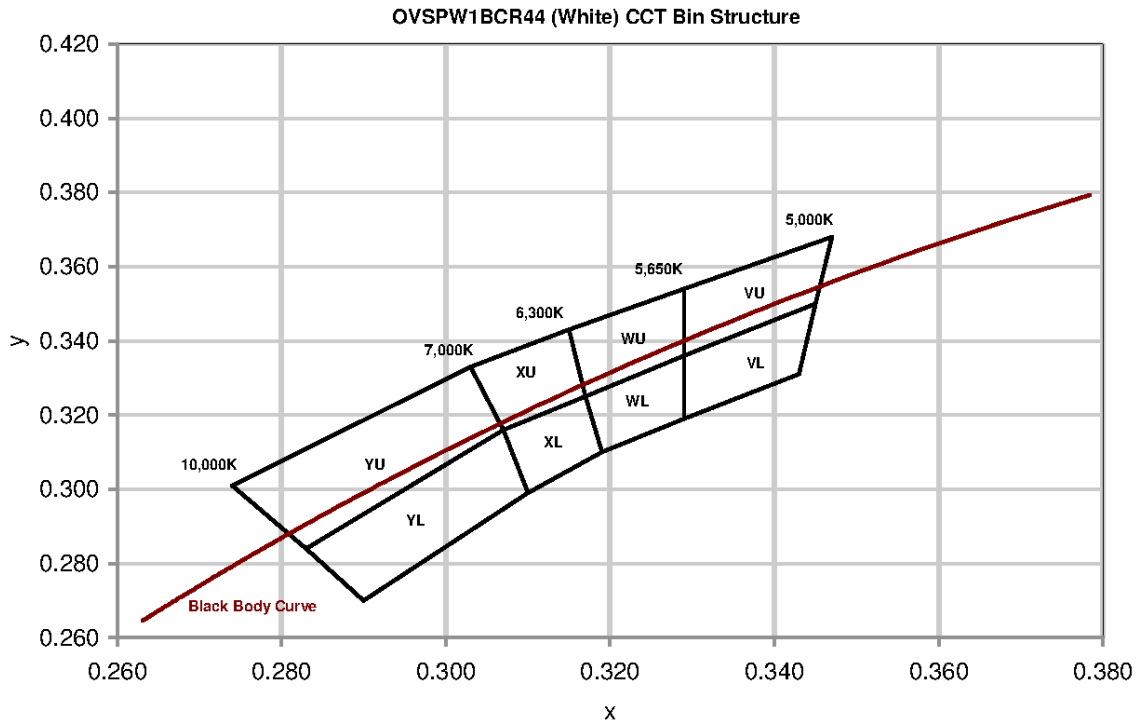

### Chromaticity Coordinates (x, y)

Rank	YU				YL			
Cx	0.274	0.283	0.307	0.303	0.283	0.290	0.310	0.307
Cy	0.301	0.284	0.316	0.333	0.284	0.270	0.299	0.316
Rank	XU				XL			
Cx	0.303	0.307	0.317	0.315	0.307	0.310	0.319	0.317
Cy	0.333	0.316	0.325	0.343	0.316	0.299	0.310	0.325
Rank	WU				WL			
Cx	0.315	0.317	0.329	0.329	0.317	0.319	0.329	0.329
Cy	0.343	0.325	0.336	0.354	0.325	0.310	0.319	0.336
Rank	VU				VL			
Cx	0.329	0.329	0.345	0.347	0.329	0.329	0.343	0.345
Cy	0.354	0.336	0.350	0.368	0.336	0.319	0.331	0.350

$I_v$	Luminous Intensity	
Bin	Min (mcd)	Max (mcd)
AJ	45,000	56,000
AK	56,000	71,500

OPTEK reserves the right to make changes at any time in order to improve design and to supply the best product possible.

# 1-Watt SMD 6x6mm Dome Lens OVSPxBCR44 Series



## Typical Electro-Optical Characteristics Curves - White

Relative Luminous Intensity Vs Forward Current

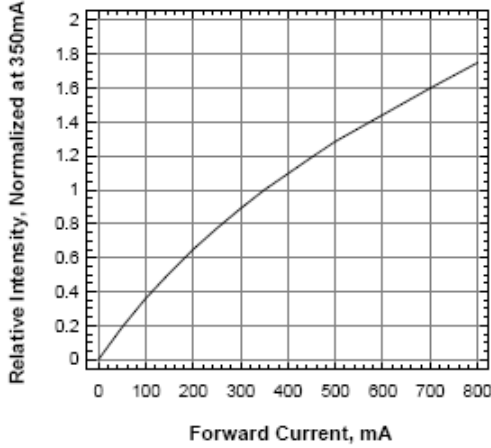

Forward Voltage Vs Forward Current

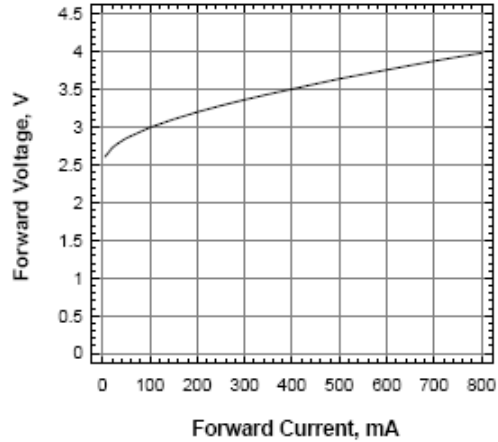

Relative Intensity Vs Wavelength

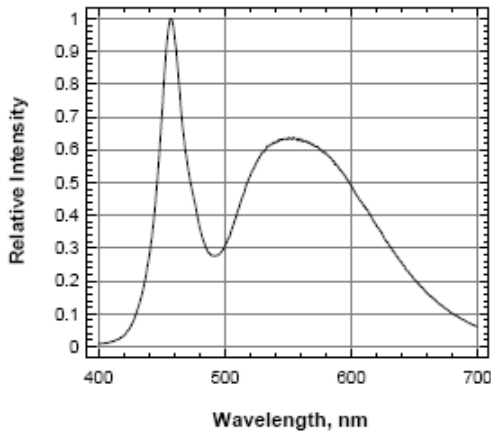

Forward Current Vs Ambient Temperature (R<sub>ja</sub>=40 K/W)

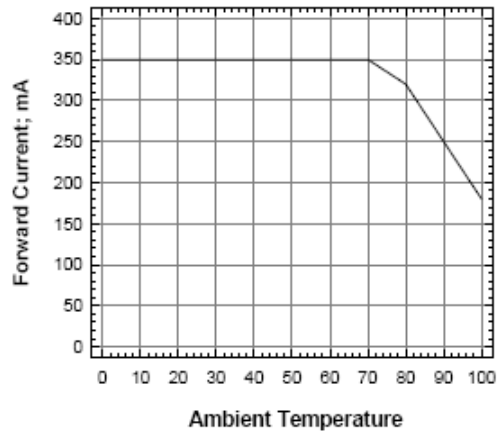

OPTEK reserves the right to make changes at any time in order to improve design and to supply the best product possible.

# 1-Watt SMD 6x6mm Dome Lens OVSPxBCR44 Series



## Typical Electro-Optical Characteristics Curves - Blue

Relative Intensity Vs Forward Current

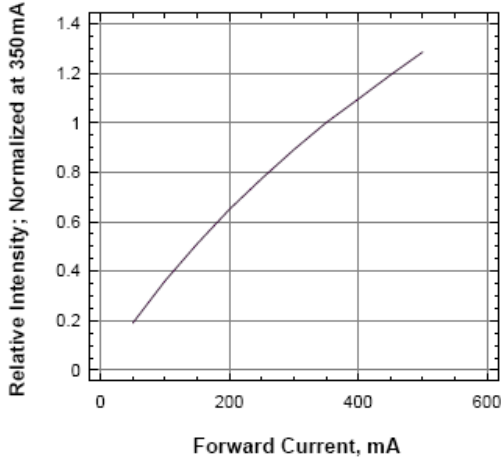

Relative Flux Vs Forward Current

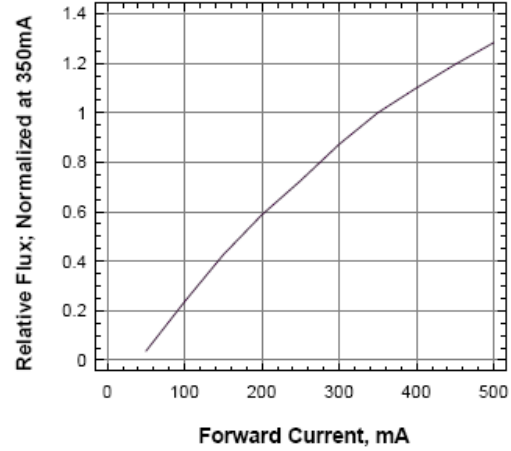

Forward Current Vs Forward Voltage

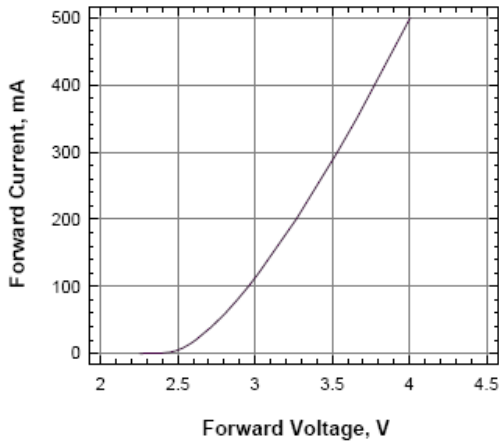

Forward Current Vs Ambient Temperature (R<sub>ja</sub>=40K/W)

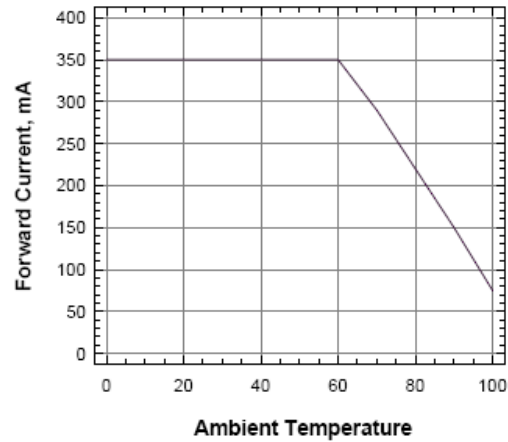

Forward Current Vs Solder Point Temperature

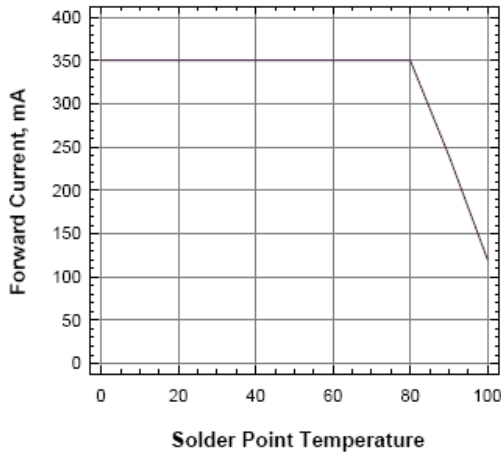

Dominant Wavelength Shift Vs Forward Current

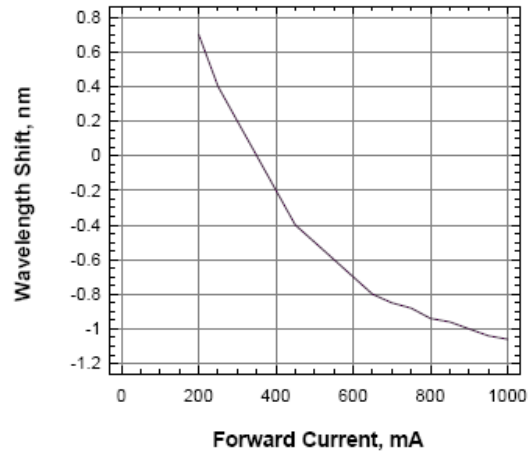

OPTEK reserves the right to make changes at any time in order to improve design and to supply the best product possible.

Typical Electro-Optical Characteristics Curves - Green

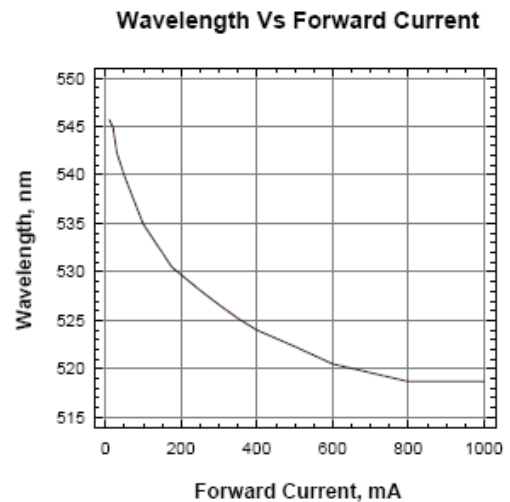
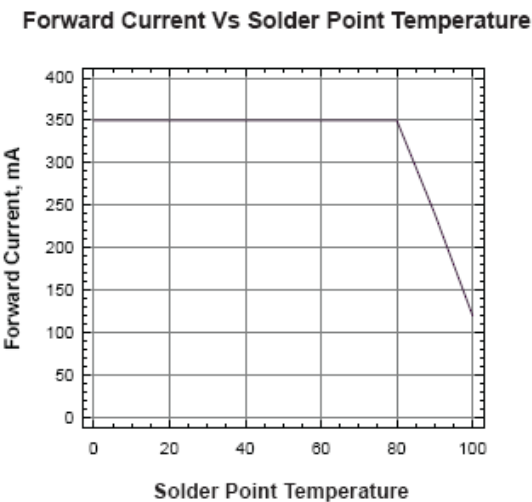
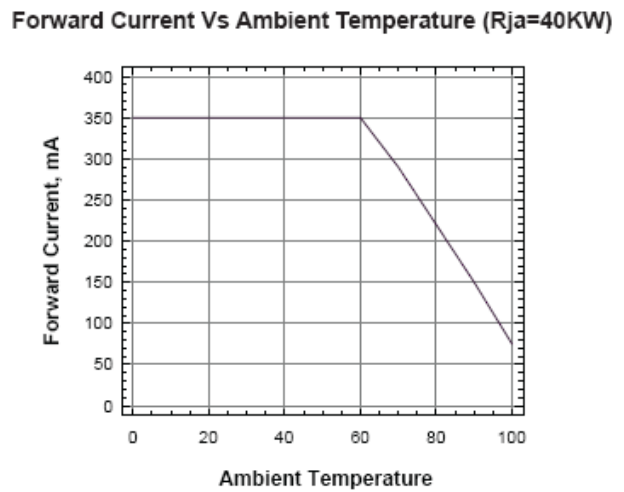
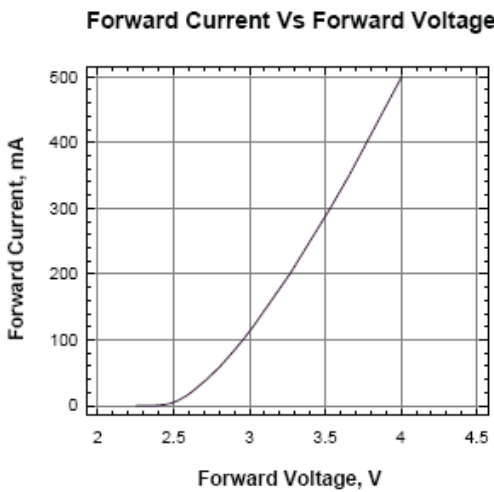
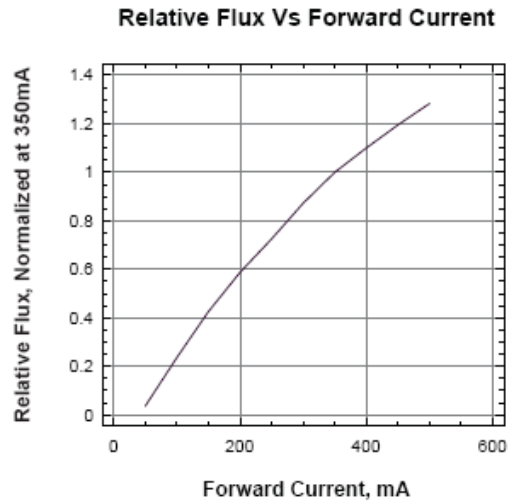
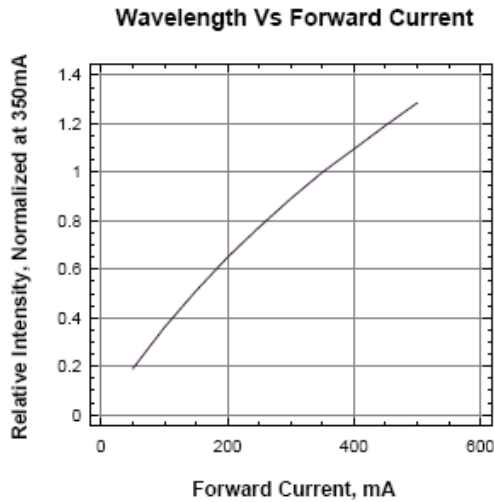

OPTEK reserves the right to make changes at any time in order to improve design and to supply the best product possible.

# 1-Watt SMD 6x6mm Dome Lens OVSPxBCR44 Series



## Typical Electro-Optical Characteristics Curves - Red & Yellow

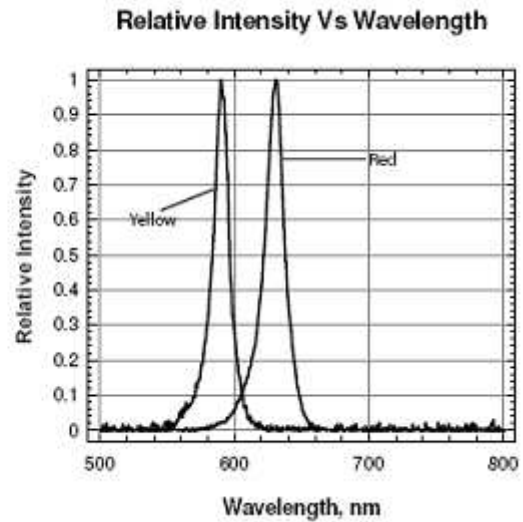
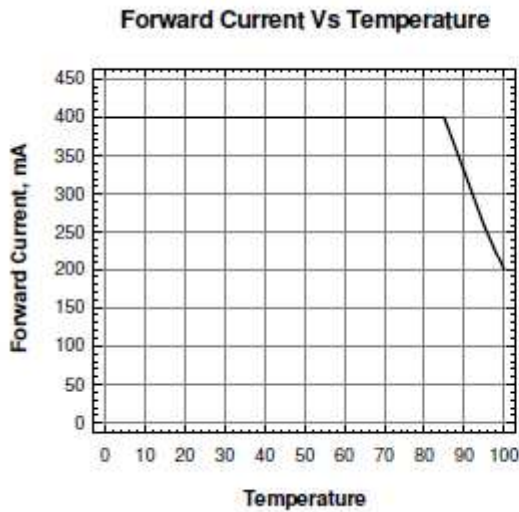
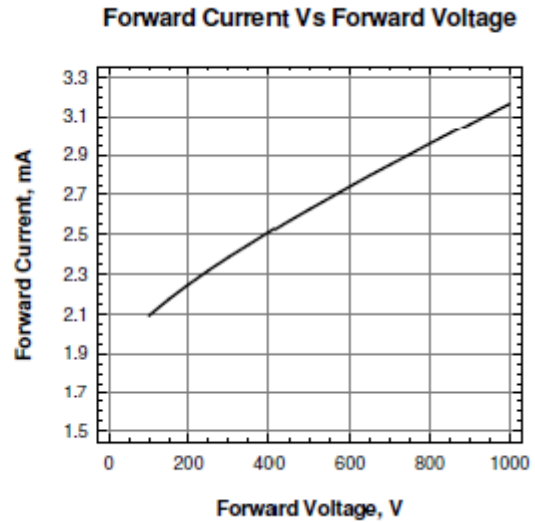
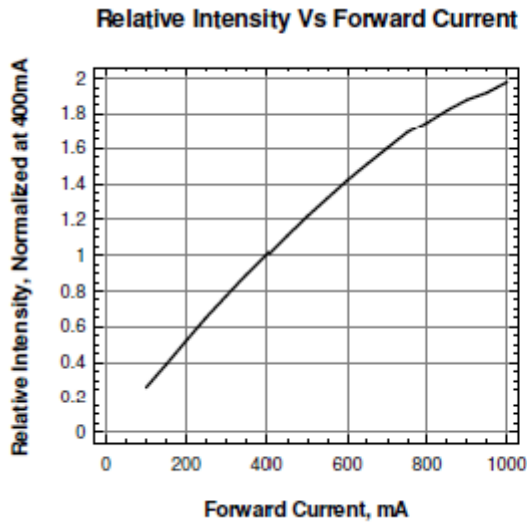

OPTEK reserves the right to make changes at any time in order to improve design and to supply the best product possible.



Recommended SN-Pb IR-Reflow Soldering Profile

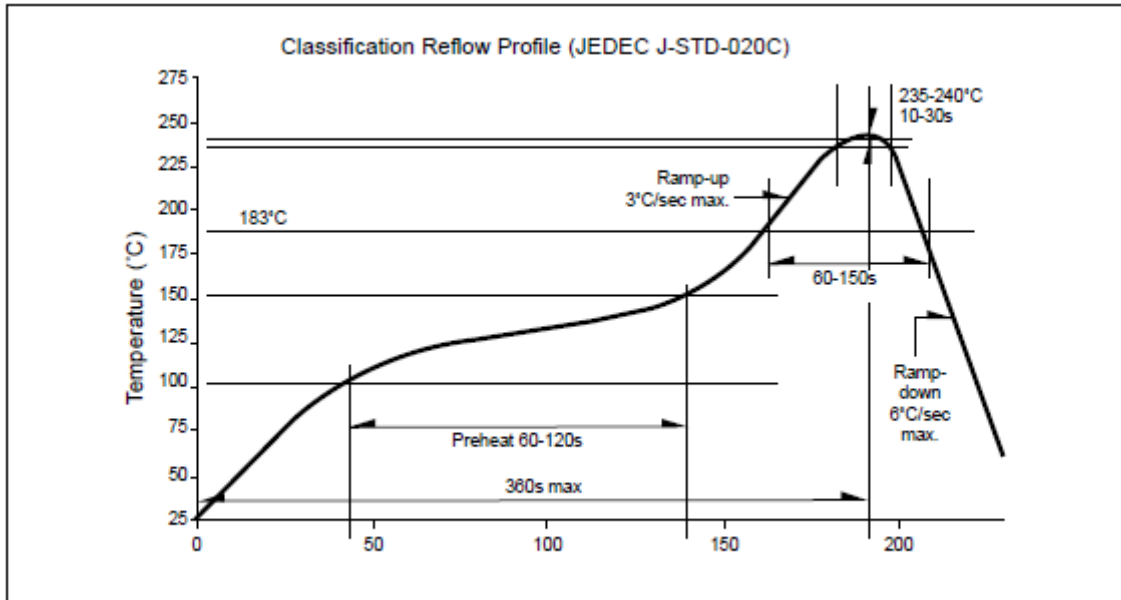

Recommended PB-free Soldering Profile

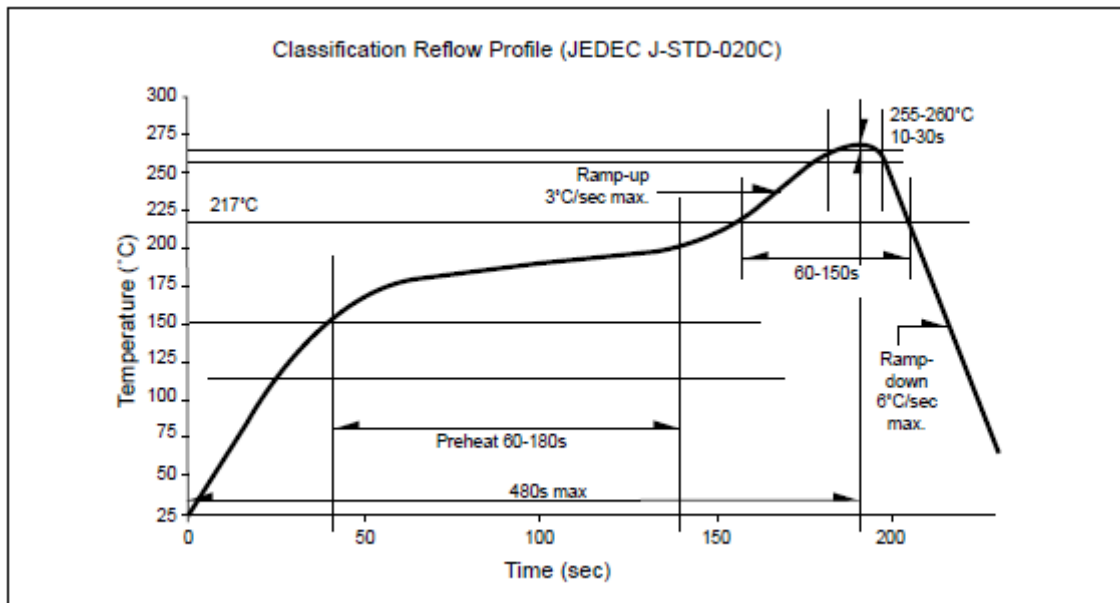

OPTeK reserves the right to make changes at any time in order to improve design and to supply the best product possible.

# 1-Watt SMD 6x6mm Dome Lens

## OVSPxBCR44 Series

### Solder Pad Design

Metal core circuit board (MCPCB) is highly recommended for high density applications.

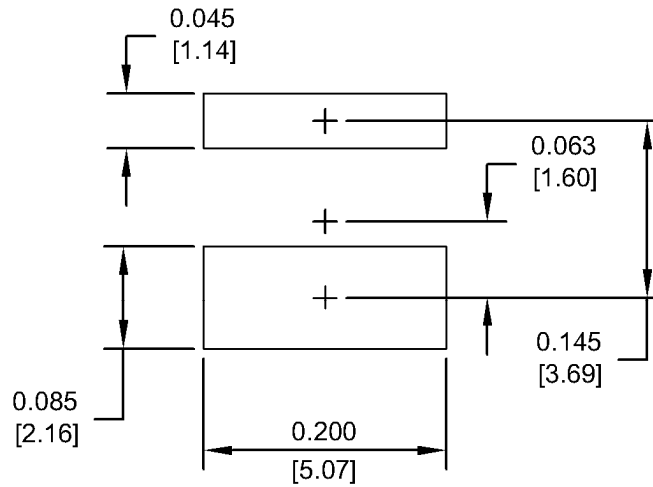

### Solder Paste Pattern

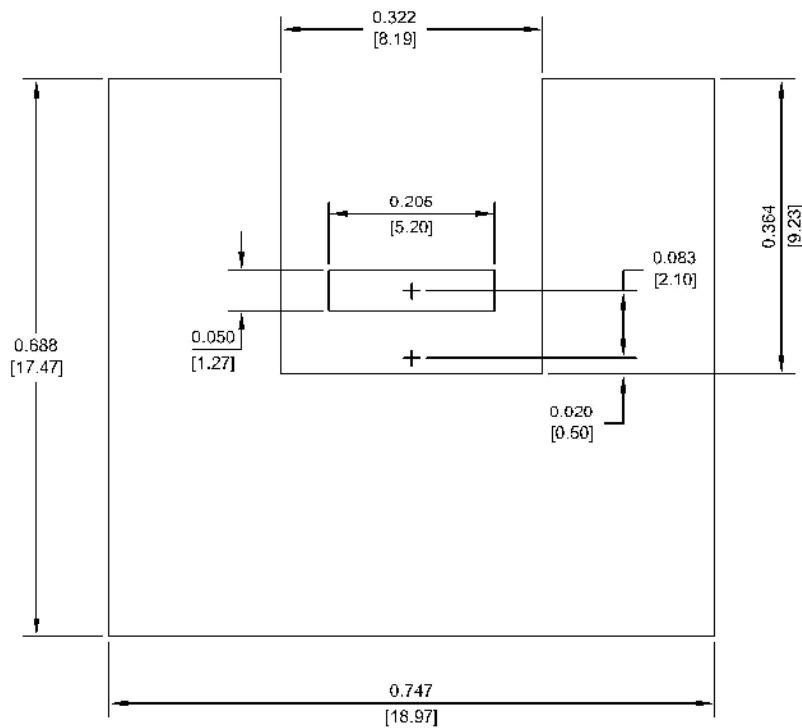

### Copper Pattern

OPTEK reserves the right to make changes at any time in order to improve design and to supply the best product possible.

# 1-Watt SMD 6x6mm Dome Lens

## OVSPxBCR44 Series



### Reel Dimensions: 13-inch reel

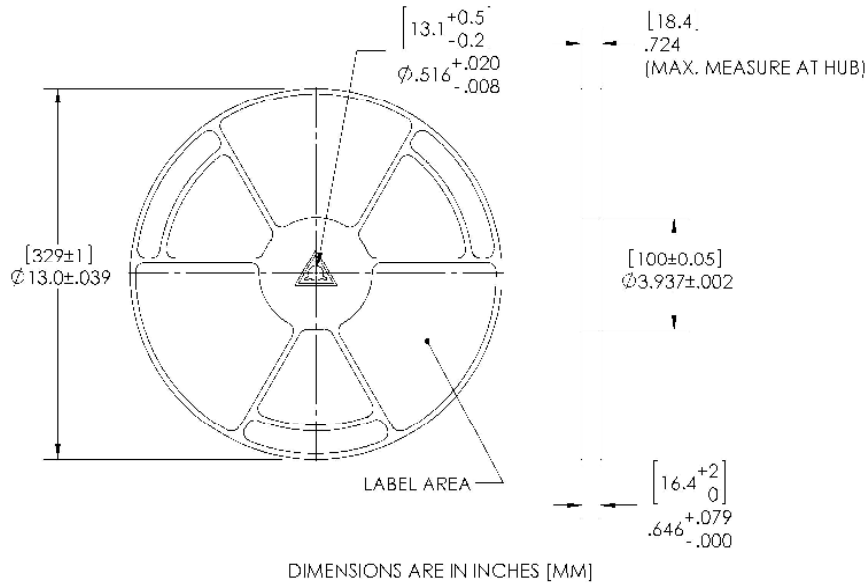

### Carrier Tape Dimensions: Loaded quantity 1000 pcs per reel

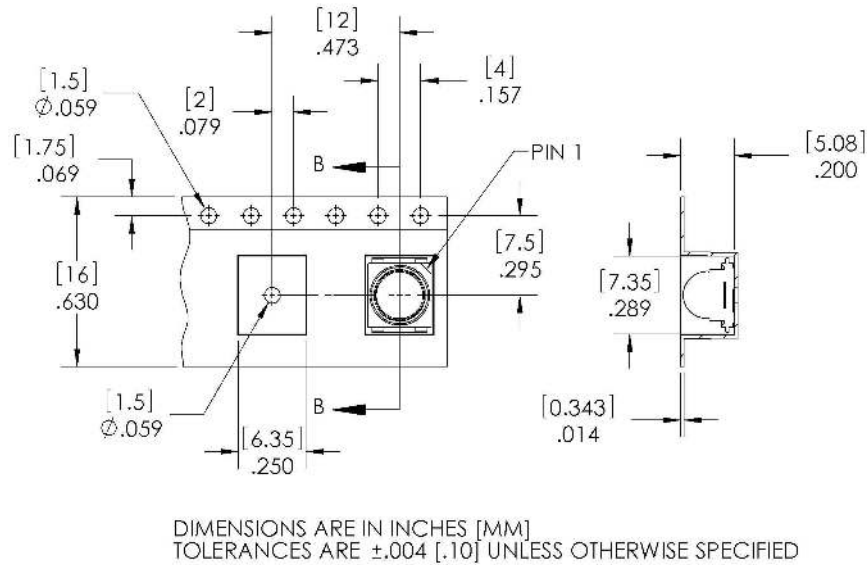

### Moisture Resistant Packaging

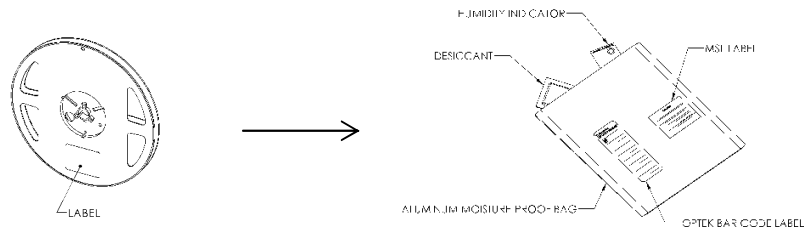

OPTEK reserves the right to make changes at any time in order to improve design and to supply the best product possible.