



Avant Evaluation Board

Technical Note

FPGA-EB-02057-1.0

January 2023

Disclaimers

Lattice makes no warranty, representation, or guarantee regarding the accuracy of information contained in this document or the suitability of its products for any particular purpose. All information herein is provided AS IS, with all faults and associated risk the responsibility entirely of the Buyer. Buyer shall not rely on any data and performance specifications or parameters provided herein. Products sold by Lattice have been subject to limited testing and it is the Buyer's responsibility to independently determine the suitability of any products and to test and verify the same. No Lattice products should be used in conjunction with mission- or safety-critical or any other application in which the failure of Lattice's product could create a situation where personal injury, death, severe property or environmental damage may occur. The information provided in this document is proprietary to Lattice Semiconductor, and Lattice reserves the right to make any changes to the information in this document or to any products at any time without notice.

Contents

Acronyms in This Document	6
1. Introduction	7
1.1. Avant-E Evaluation Board	7
1.2. Features	7
1.3. Avant-E Device	10
1.4. Applying Power to the Board	10
2. Jumper Definition	11
3. Power Scheme	16
4. Programming	19
4.1. JTAG Download Interface	19
4.2. Alternate JTAG Download Interface	19
4.3. SPI Flash Device Selection in Programmer	20
4.4. Global Setting in Lattice Radiant software	21
4.5. Other Configuration Pins	25
5. Avant Clock Sources	26
6. Control Buses – I ² C, UART, and SPI	27
6.1. I ² C Topology	27
6.2. UART Topology	27
6.3. SPI Topology	27
7. LEDs, Switches and Segment Displays	28
7.1. DIP Switch	28
7.2. General Purpose Push Buttons	28
7.3. General Purpose LEDs	29
7.4. Segment Displays	29
8. Headers/Connectors and Avant Device Ball Mapping	30
8.1. FMC1 Connector	30
8.2. FMC2 Connector	33
8.3. Parallel FMC1 Configuration Header	37
8.4. Parallel FMC2 Configuration Header	37
8.5. Raspberry PI Board GPIO Header	37
8.6. External Flash Configuration Header	39
8.7. PMOD Header	39
8.8. Through Hole Extended Area Header	40
9. Software Requirements	42
10. Storage and Handling	42
11. Ordering Information	42
Appendix A. Avant Evaluation Board Schematics	43
Appendix B. Avant Evaluation Board Bill of Materials	62
References	75
Technical Support Assistance	76
Revision History	77

Figures

Figure 1.1. Top View of Avant-E Evaluation Board	8
Figure 1.2. Bottom View of Avant Evaluation Board	9
Figure 1.3. 12 V DC Power Supply	10
Figure 2.1. Top View of Avant Evaluation Board – Jumper Locations	11
Figure 3.1. Board Power Scheme (1)	16
Figure 3.2. Board Power Scheme (2)	17
Figure 4.1. Configuration, UART and I ² C Architecture	19
Figure 4.2. SPI Flash Operation Dialog	20
Figure 4.3. Global Settings (1)	22
Figure 4.4. Global Settings (2)	23
Figure 4.5. Global Settings (3)	24
Figure A.1. Title Page	43
Figure A.2. Block Diagram	44
Figure A.3. USB Interface	45
Figure A.4. Bank-0/1 Flash, LEDs, FMC & Raspberry Pi	46
Figure A.5. Bank-2 JTAG, UART, Config & Raspberry Pi	47
Figure A.6. Bank-3/4/5 FMC1 & FMC2	48
Figure A.7. HPC FMC1	49
Figure A.8. Bank-6 Switches, Buttons, LEDs & Extended Bank	50
Figure A.9. Bank-7/8/9 FMC2	51
Figure A.10. HPC FMC2	52
Figure A.11. LPDDR4	53
Figure A.12. Bank-12/13 PMODs, FMC2 & Raspberry Pi	54
Figure A.13. Bank-14 Segment Display & Raspberry Pi	55
Figure A.14. Bank Power	56
Figure A.15. Power Decoupling	57
Figure A.16. Power Supplies 1	58
Figure A.17. Power Supplies 2	59
Figure A.18. Ground	60
Figure A.19. Power Block Diagram	61

Tables

Table 1.1. Board Power Supply	10
Table 2.1. Jumper Setting	12
Table 3.1. V _{CCIO} Supply Options	17
Table 3.2. Status LED Definition	18
Table 4.1. JTAG Connections	19
Table 4.2. Other Configuration Signals	25
Table 5.1. Clock Sources	26
Table 6.1. I ² C Bus Connections	27
Table 6.2. UART Bus Connections	27
Table 6.3. SPI Bus Connections	27
Table 7.1. DIP Switch Signals	28
Table 7.2. Push Button Switch Signals	28
Table 7.3. General Purpose LED Signals	29
Table 7.4. Segment Display	29
Table 8.1. FMC1 Pin Connections	30
Table 8.2. FMC2 Pin Connections	33
Table 8.3. Parallel FMC1 Configuration Header Pin Connections	37
Table 8.4. Parallel FMC2 Configuration Header Pin Connections	37

Table 8.5. Raspberry PI header Pin Connections	37
Table 8.6. SPI Flash Configuration Header Pin Connections	39
Table 8.7. PMOD Header Pin Connections	39
Table 8.8. Through Hole Extended Area Header Pin Connections	40
Table 11.1. Ordering Information	42

Acronyms in This Document

A list of acronyms used in this document.

Acronym	Definition
AC/DC	Alternating Current and Direct Current
ADC	Analog-to-digital Converter
DIP	Dual Inline Package
ESD	Electro Static Discharge
FMC	FPGA Mezzanine Card
FPGA	Field Programmable Gate Array
FTDI	Future Technology Devices International
GPIO	General Purpose Input/Output
HPC	High Pin Connector
I2C	Inter-Integrated Circuit
I/O	Input/Output
JTAG	Joint Test Action Group
LED	Light Emitting Diode
LVDS	Low-Voltage Differential Signaling
OSC	Oscillator
PC	Personal Computer
PMOD	Peripheral Module
POT	Potentiometer
SerDes	Serializer/Deserializer
SMA	Subminiature Version A
SPI	Serial Peripheral Interface
UART	Universal Asynchronous Receiver Transmitter
USB	Universal Serial Bus

1. Introduction

The Lattice Semiconductor Avant™-E Evaluation Board allows you to investigate and experiment with the features of the Avant-E Field Programmable Gate Array (FPGA). The features of the Avant-E Evaluation Board can assist you with the rapid prototyping and testing of your specific design. The Avant-E Evaluation board is part of the Avant-E Evaluation Board Kit. This guide is intended to be referenced to demonstrate the Avant-E FPGA and introduce board resources.

The Avant-E Evaluation Board Kit includes the following:

- Avant-E Evaluation Board is pre-loaded with blinking lights demo design.
- USB-A to USB-B (Mini) cable for programming FPGA SRAM through a PC
 - Lattice Programming Cable is needed to program the Flash device at this time.
 - Programming Cable can be ordered here:
<https://www.latticesemi.com/products/developmentboardsandkits/programmingcablesforpcs>
 - Future revisions of the board can allow programming of the Flash device through on-board J2 mini USB connector, eliminating the need of the Lattice Programming Cable.
- 12 V AC/DC power adapter and international plug adapters
- Lattice Radiant® software download information

The contents of this user guide include top-level functional descriptions of the various portions of the evaluation board, descriptions of the on-board headers, status indicators, push buttons and switches and a complete set of schematics.

1.1. Avant-E Evaluation Board

The Avant-E Evaluation Board features the Avant-E FPGA in the LFG1156 package. The board has the ability to expand the usability of the Avant-E FPGA with FMC HPC, PMOD, and Raspberry PI connectors. Easy-to-use board resources of the jumpers, LED indicators, push buttons and switches are available for user-defined applications.

[Figure 1.1](#) shows the top view of Avant-E Evaluation Board. [Figure 1.2](#) shows the bottom view of Avant-E Evaluation Board.

1.2. Features

The Avant-E Evaluation Board includes the following features:

- Avant-E FPGA (LAV-AT-500E-3LFG1156C)
- General purpose Input/Output (GPIO) breakout with 2 FMC, PMOD, and Raspberry PI connectors
- Total of 95 wide-range I/O and 468 high-speed differential I/O (234 pairs) extended onboard
- USB-B (Mini) connection for device programming
- On-board Boot Flash – 512 Mb Serial Peripheral Interface (SPI) Flash, with Single/Dual/Quad support
- Eight input DIP switches, four push buttons, eight green LEDs, eight red LEDs and three seven-segment LEDs for designer configuration
- Lattice Radiant® software programming support
- Two reference clock sources

Caution: The Avant-E Evaluation Board contains ESD-sensitive components. ESD safe practices should be followed while handling and using the evaluation board.

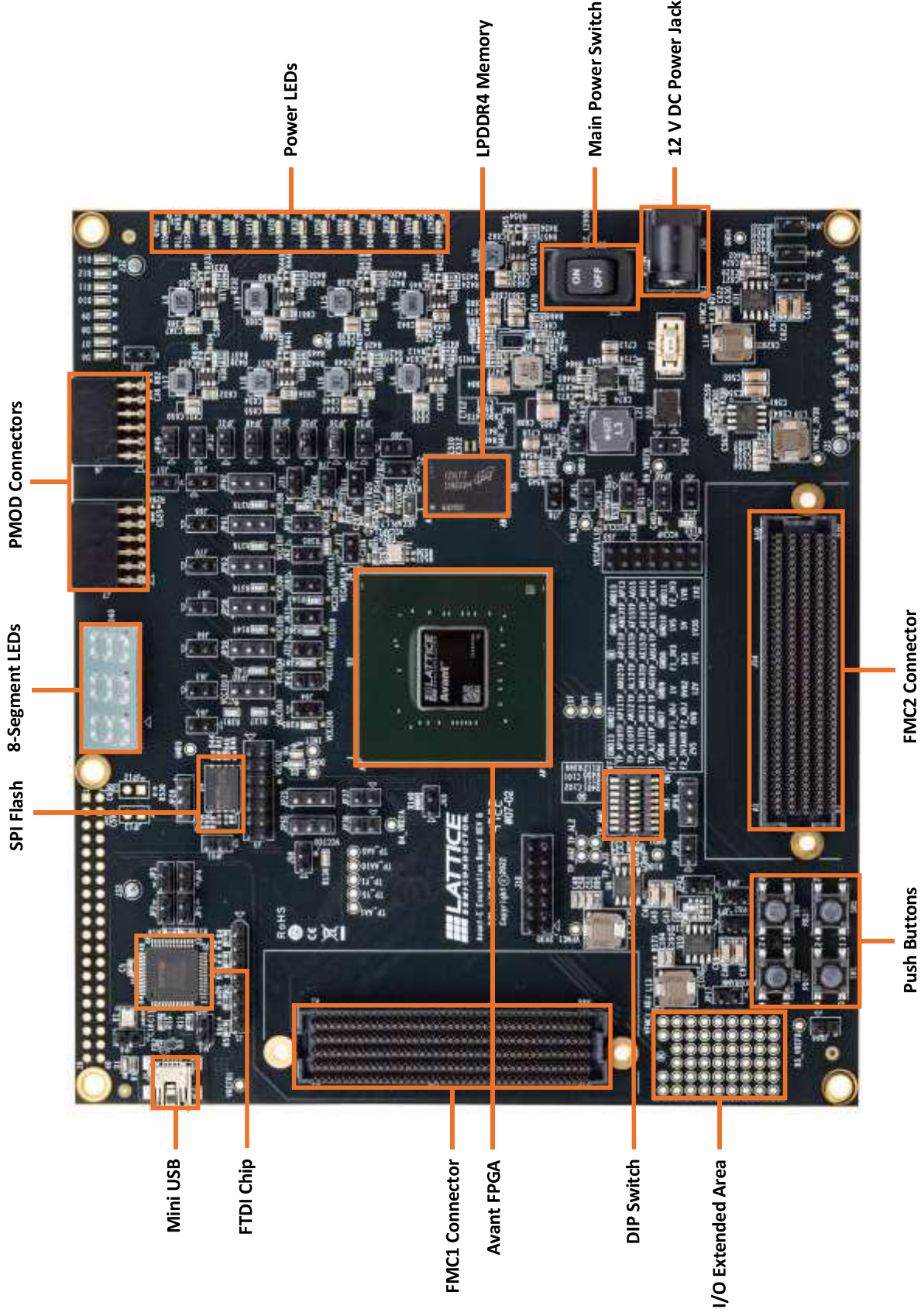

Figure 1.1. Top View of Avant-E Evaluation Board

© 2022-2023 Lattice Semiconductor Corp. All Lattice trademarks, registered trademarks, patents, and disclaimers are as listed at www.latticesemi.com/legal. All other brand or product names are trademarks or registered trademarks of their respective holders. The specifications and information herein are subject to change without notice.

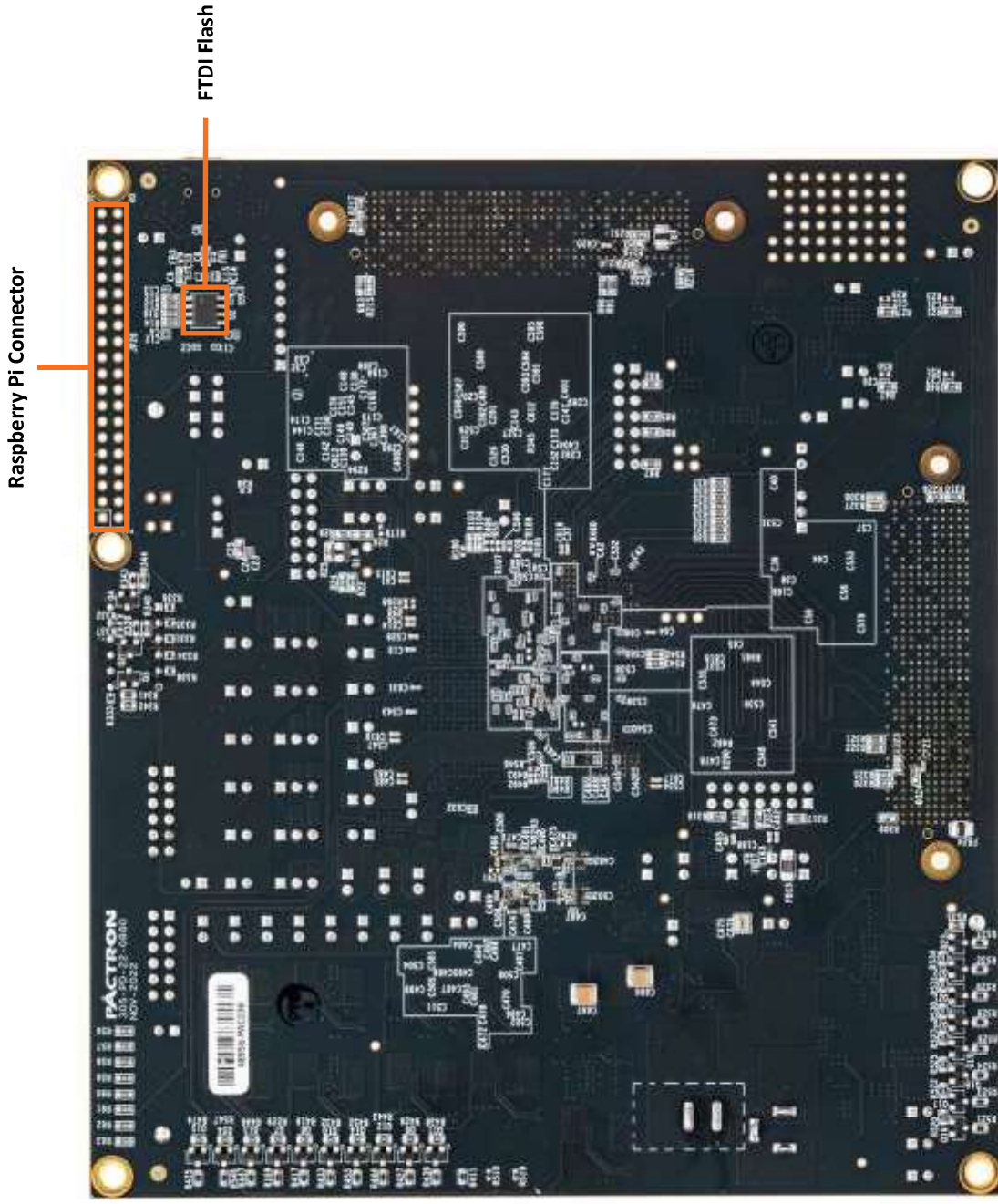

Figure 1.2. Bottom View of Avant Evaluation Board

1.3. Avant-E Device

The Avant-E Evaluation Board features the Avant-E device in an LFG1156 package, also referred to as LAV-AT-500E-3LFG1156C. The low-power general purpose FPGA can be used in a wide range of applications across multiple markets and is optimized for bridging and processing needs in edge applications. For more information on the capabilities of Avant-E device, see [Avant Platform Data Sheet – Overview \(FPGA-DS-02107\)](#) and [Avant Platform Data Sheet – Specifications \(FPGA-DS-02112\)](#).

1.4. Applying Power to the Board

The Avant-E Evaluation Board can be powered up using the 12 V AC/DC power adapter included with the kit. The power adapter should be connected to power input jack J50, which is connected to fuse F2, as shown in [Figure 1.3](#) and [Table 1.1](#). The fuse can prevent the crashed current from flowing into the internal circuits and cause serious damage. Power LEDs light up after connecting the 12 V DC power and toggling SW6 to the ON position to indicate that the board is getting the proper board voltages.



Figure 1.3. 12 V DC Power Supply

Table 1.1. Board Power Supply

Part Designator	Description
J50	12 V DC Input Supply Jack
F2	12 V DC Input Supply Fuse
SW6	ON/OFF Switch

2. Jumper Definition

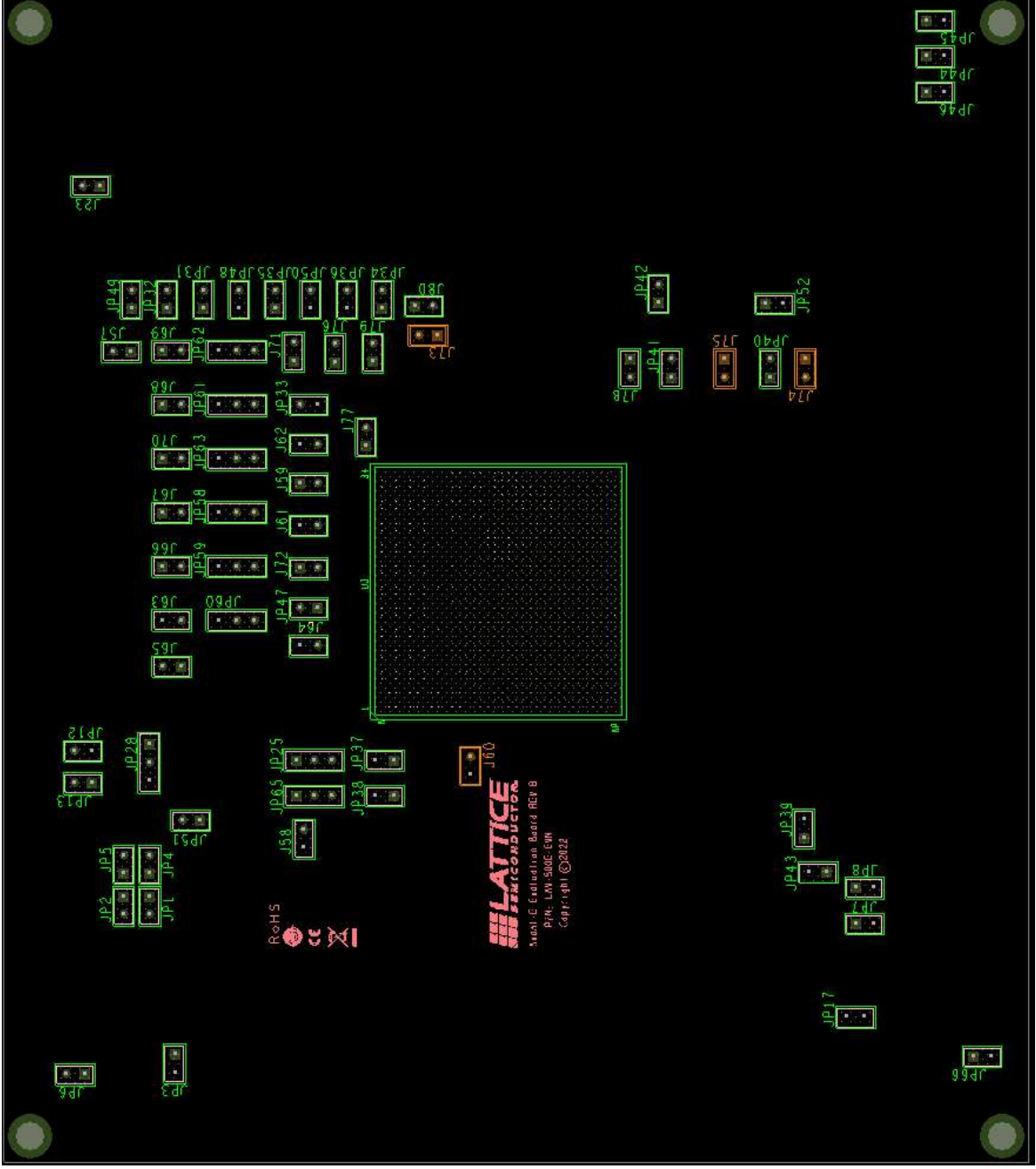

Figure 2.1. Top View of Avant Evaluation Board – Jumper Locations

© 2022-2023 Lattice Semiconductor Corp. All Lattice trademarks, registered trademarks, patents, and disclaimers are as listed at www.latticesemi.com/legal. All other brand or product names are trademarks or registered trademarks of their respective holders. The specifications and information herein are subject to change without notice.

Table 2.1. Jumper Setting

Part Designator	Description	Setting	Default
J23	Power Measurement Header for PMOD Header J6		
J58	Power Measurement Header for VCCIO0		
J57	Power Measurement Header for PMOD Header J6		
J59	Power Measurement Header for VCCIO1		
J60	Power Measurement Header for VCCIO2		
J61	Power Measurement Header for VCCIO10		
J62	Power Measurement Header for VCCIO11		
J63	Power Measurement Header for VCCIO13		
J64	Power Measurement Header for VCCIO14		
J65	Power Measurement Header for VCCIO3		
J66	Power Measurement Header for VCCIO4		
J67	Power Measurement Header for VCCIO5		
J68	Power Measurement Header for VCCIO7		
J69	Power Measurement Header for VCCIO8		
J70	Power Measurement Header for VCCIO9		
J71	Power Measurement Header for VCCIO6		
J72	Power Measurement Header for VCCIO12		
J73	Power Measurement Header for Avant VCC		
J74	Power Measurement Header for Avant VCCHP		
J75	Power Measurement Header for Avant VCCCLK		
J76	Power Measurement Header for Avant VCCAUX		
J77	Power Measurement Header for Avant VCCAPLLW		
J78	Power Measurement Header for Avant VCCAPLL10		
J79	Power Measurement Header for Avant VCCAPLL4		
J80	Power Measurement Header for Avant VCCAPLL7		
JP1, JP2	FTDI UART Debug	Open – UART bus unconnected Close – UART bus connected	Close
JP3	FTDI Reset	Open – FTDI active Close – Holds FTDI in reset	Open
JP4, JP5	FTDI I ² C	Open – I ² C bus unconnected Close – I ² C bus connected	Open
JP6	FTDI 12 MHz Oscillator Jumper	Open – 12 MHz oscillator goes only to FTDI chip Close – 12 MHz oscillator goes to FTDI chip & ball U3 of FPGA through JP65	Open
JP7	JP7, JP8 & JP43 are Used to Select U10 Voltage Output	JP7 – Open, JP8 – Open, JP43 – Open: U10 Output = 1.5 V JP7 – Open, JP8 – Close, JP43 – Open: U10 Output = 1.8 V JP7 – Close, JP8 – Open, JP43 – Open: U10 Output = 2.5 V JP7 – Open, JP8 – Open, JP43 – Close: U10 Output = 3.3 V	Open
JP8	JP7, JP8 & JP43 are Used to Select U10 Voltage Output	JP7 – Open, JP8 – Open, JP43 – Open: U10 Output = 1.5 V JP7 – Open, JP8 – Close, JP43 – Open: U10 Output = 1.8 V JP7 – Close, JP8 – Open, JP43 – Open: U10 Output = 2.5 V	Close

Part Designator	Description	Setting	Default
		JP7 – Open, JP8 – Open, JP43 – Close: U10 Output = 3.3 V	
JP12	Raspberry PI Connector (JP26) Power	Open – Raspberry PI self-power Close – 3.3 V supplied to Raspberry PI connector	Open
JP13	Raspberry PI Connector (JP26) Power	Open – Raspberry PI self-power Close – 5.0 V supplied to Raspberry PI connector	Open
JP17	PROGRAMN Pull-down Jumper	Open – MSPI boot mode Close – Secondary configuration mode	Open
JP25	FPGA Configuration Mode Select	1–2 – Secondary boot mode, external Main configures Avant’s SRAM 2–3 – Main auto boot mode, Avant downloads bitstream from external Flash	2–3
JP28	Flash Power Source	1–2 – Flash (U4) powered by VCCIO1_IN 2–3 – Flash (U4) powered by VCC_3V30	2–3
JP31	Avant Bank 6 Power Select (VCCIO6)	JP31, JP32, JP33, JP34, JP35 & JP36 select voltage to VCCIO6. Only one of these jumpers should be inserted. Open – VCCIO6 voltage based on JP32, JP33, JP34, JP35 & JP36 settings Close – VCCIO6 = 0.9 V	Open
JP32	Avant Bank 6 Power Select (VCCIO6)	JP31, JP32, JP33, JP34, JP35 & JP36 select voltage to VCCIO6. Only one of these jumpers should be inserted. Open – VCCIO6 voltage based on JP31, JP33, JP34, JP35 & JP36 settings Close – VCCIO6 = 1.0 V	Open
JP33	Avant Bank 6 Power Select (VCCIO6)	JP31, JP32, JP33, JP34, JP35 & JP36 select voltage to VCCIO6. Only one of these jumpers should be inserted. Open – VCCIO6 voltage based on JP31, JP32, JP34, JP35 & JP36 settings Close – VCCIO6 = 1.1 V	Open
JP34	Avant Bank 6 Power Select (VCCIO6)	JP31, JP32, JP33, JP34, JP35 & JP36 select voltage to VCCIO6. Only one of these jumpers should be inserted. Open – VCCIO6 voltage based on JP31, JP32, JP33, JP35 & JP36 settings Close – VCCIO6 = 1.35 V	Open
JP35	Avant Bank 6 Power Select (VCCIO6)	JP31, JP32, JP33, JP34, JP35 & JP36 select voltage to VCCIO6. Only one of these jumpers should be inserted. Open – VCCIO6 voltage based on JP31, JP32, JP33, JP34 & JP36 settings Close – VCCIO6 = 1.5 V	Open
JP36	Avant Bank 6 Power Select (VCCIO6)	JP31, JP32, JP33, JP34, JP35 & JP36 select voltage to VCCIO6. Only one of these jumpers should be inserted. Open – VCCIO6 voltage based on JP31, JP32, JP33, JP34 & JP35 settings Close – VCCIO6 = 1.8 V	Close
JP37	FMC1 Reference Voltage	Open – Leaves FMC1 VREF_A_M2C (J48D.H1) pin open Close – Connects Avant ball AA11 to FMC1 VREF_A_M2C (J48D.H1)	Open

Part Designator	Description	Setting	Default
JP38	FMC1 Reference Voltage	Open – Leaves FMC1 VREF_A_M2C (J48D.H1) pin open Close – Connects Avant ball AG6 to FMC1 VREF_A_M2C (J48D.H1)	Open
JP39	FMC1 Reference Voltage	Open – Leaves FMC1 VREF_A_M2C (J48D.H1) pin open Close – Connects Avant ball AF13 to FMC1 VREF_A_M2C (J48D.H1)	Open
JP40	FMC2 Reference Voltage	Open – Leaves FMC2 VREF_A_M2C (J54D.H1) pin open Close – Connects Avant ball AF18 to FMC2 VREF_A_M2C (J54D.H1)	Open
JP41	FMC2 Reference Voltage	Open – Leaves FMC2 VREF_A_M2C (J54D.H1) pin open Close – Connects Avant ball AF27 to FMC2 VREF_A_M2C (J54D.H1)	Open
JP42	FMC2 Reference Voltage	Open – Leaves FMC2 VREF_A_M2C (J54D.H1) pin open Close – Connects Avant ball AF24 to FMC2 VREF_A_M2C (J54D.H1)	Open
JP43	JP7, JP8 & JP43 are Used to Select U10 Voltage Output	JP7 – Open, JP8 – Open, JP43 – Open: U10 Output = 1.5 V JP7 – Open, JP8 – Close, JP43 – Open: U10 Output = 1.8 V JP7 – Close, JP8 – Open, JP43 – Open: U10 Output = 2.5 V JP7 – Open, JP8 – Open, JP43 – Close: U10 Output = 3.3 V	Open
JP44	JP44, JP45 & JP46 are Used to Select U31 Voltage Output	JP44 – Open, JP45 – Open, JP46 – Open: U31 Output = 1.5 V JP44 – Open, JP45 – Open, JP46 – Close: U31 Output = 1.8 V JP44 – Close, JP45 – Open, JP46 – Open: U31 Output = 2.5 V JP44 – Open, JP45 – Close, JP46 – Open: U31 Output = 3.3 V	Open
JP45	JP44, JP45 & JP46 are Used to Select U31 Voltage Output	JP44 – Open, JP45 – Open, JP46 – Open: U31 Output = 1.5 V JP44 – Open, JP45 – Open, JP46 – Close: U31 Output = 1.8 V JP44 – Close, JP45 – Open, JP46 – Open: U31 Output = 2.5 V JP44 – Open, JP45 – Close, JP46 – Open: U31 Output = 3.3 V	Open
JP46	JP44, JP45 & JP46 are Used to Select U31 Voltage Output	JP44 – Open, JP45 – Open, JP46 – Open: U31 Output = 1.5 V JP44 – Open, JP45 – Open, JP46 – Close: U31 Output = 1.8 V JP44 – Close, JP45 – Open, JP46 – Open: U31 Output = 2.5 V JP44 – Open, JP45 – Close, JP46 – Open: U31 Output = 3.3 V	Close
JP47	Avant Bank 12 Power Select (VCCIO12)	JP47, JP48, JP49 & JP50 select voltage to VCCIO12. Only one of these jumpers should be inserted.	Open

Part Designator	Description	Setting	Default
		Open – VCCIO12 voltage based on JP48, JP49 & JP50 settings Close – VCCIO12 = 1.2 V	
JP48	Avant Bank 12 Power Select (VCCIO12)	JP47, JP48, JP49 & JP50 select voltage to VCCIO12. Only one of these jumpers should be inserted. Open – VCCIO12 voltage based on JP47, JP49 & JP50 settings Close – VCCIO12 = 1.8 V	Open
JP49	Avant Bank 12 Power Select (VCCIO12)	JP47, JP48, JP49 & JP50 select voltage to VCCIO12. Only one of these jumpers should be inserted. Open – VCCIO12 voltage based on JP47, JP48 & JP50 settings Close – VCCIO12 = 2.5 V	Open
JP50	Avant Bank 12 Power Select (VCCIO12)	JP47, JP48, JP49 & JP50 select voltage to VCCIO12. Only one of these jumpers should be inserted. Open – VCCIO12 voltage based on JP48 & JP49 settings Close – VCCIO12 = 1.2 V	Close
JP51	SPI Chip Select	Open – Flash (U4) CS# is only connected to pin 2 of J3 Header Close – Connects Avant MCSN ball (P7) to Flash (U4) CS# pin	Close
JP52	FMC2 Reference Voltage	Open – Leaves FMC2 VREF_B_M2C (J54E.K1) pin open Close – Connects Avant ball AF23 to FMC2 VREF_A_M2C (J54E.K1)	Open
JP58	Avant Bank 5 Power Select (VCCIO5)	1–2 – VCCIO5 = 1.8 V 2–3 – VCCIO5 = 1.2 V	1–2
JP59	Avant Bank 4 Power Select (VCCIO4)	1–2 – VCCIO4 = 1.8 V 2–3 – VCCIO4 = 1.2 V	1–2
JP60	Avant Bank 3 Power Select (VCCIO3)	1–2 – VCCIO3 = 1.8 V 2–3 – VCCIO3 = 1.2 V	1–2
JP61	Avant Bank 7 Power Select (VCCIO7)	1–2 – VCCIO7 = 1.8 V 2–3 – VCCIO7 = 1.2 V	1–2
JP62	Avant Bank 8 Power Select (VCCIO8)	1–2 – VCCIO8 = 1.8 V 2–3 – VCCIO8 = 1.2 V	1–2
JP63	Avant Bank 9 Power Select (VCCIO9)	1–2 – VCCIO9 = 1.8 V 2–3 – VCCIO9 = 1.2 V	1–2
JP65	Avant Ball U3	1–2 – Avant ball U3 connected to Raspberry Pi Header (JP26) pin 7 2–3 – Avant ball U3 connected to 12 MHz oscillator (X1) through JP6 jumper	1–2
JP66	FMC2 Reference Voltage	Open – Leaves FMC2 VREF_B_M2C (J54E.K1) pin open Close – Connects Avant ball AE13 to FMC2 VREF_B_M2C (J48D.H1)	Open

3. Power Scheme

The Avant Evaluation Board has majority of on-board regulators powered by 12 V and 5 V power. Refer to [Appendix A. Avant Evaluation Board Schematics](#) to see the details of these power supply options.

[Figure 3.1](#) and [Figure 3.2](#) show the high-level power supply architecture of the board. [Table 3.1](#) shows the voltage options available for various V_{CCIO} supplies.

The Avant Evaluation Board has two FMC connectors, designated as FMC1 and FMC2. The VFMC1_ADJ and VFMC2_ADJ power supplies are required for the two FMC connectors according to the FMC standard. You can set the power output level by changing the jumpers (JP7, JP8 and JP43) for FMC1 and (JP44, JP45 and JP46) for FMC2.

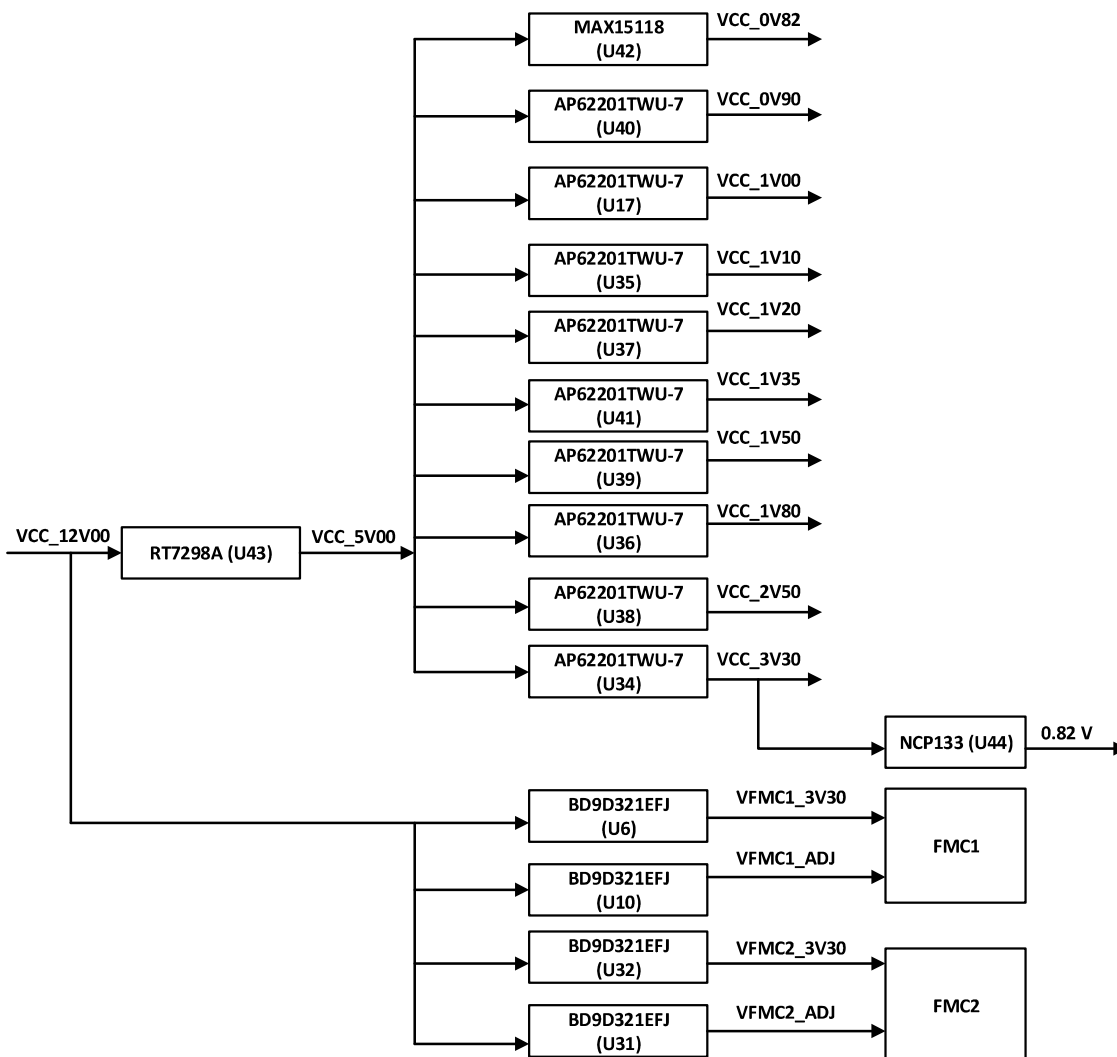

Figure 3.1. Board Power Scheme (1)

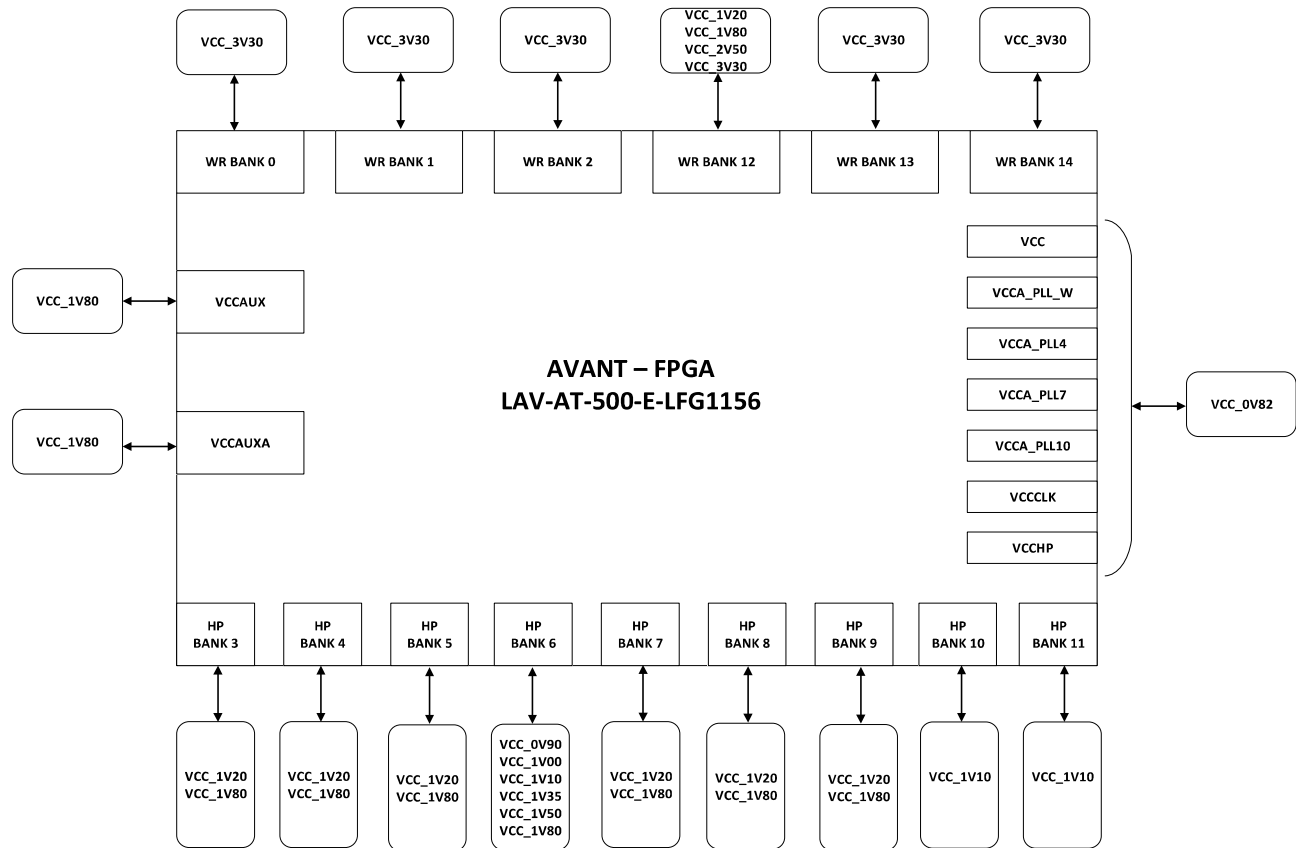

Figure 3.2. Board Power Scheme (2)

Table 3.1. V_{CCIO} Supply Options

V _{CCIO} Bank	3.30 V	2.50 V	1.80 V	1.50 V	1.35 V	1.20 V	1.10 V	1.00 V	0.90 V
V _{CCIO0}	Fixed	—	—	—	—	—	—	—	—
V _{CCIO1}	Fixed	—	—	—	—	—	—	—	—
V _{CCIO2}	Fixed	—	—	—	—	—	—	—	—
V _{CCIO3}	—	—	Default	—	—	Selectable	—	—	—
V _{CCIO4}									
V _{CCIO5}									
V _{CCIO6}	Default		Selectable	Selectable	Selectable	—	Selectable	Selectable	Selectable
V _{CCIO7}	—	—	Default	—	—	Selectable	—	—	—
V _{CCIO8}									
V _{CCIO9}									
V _{CCIO10}	—	—	—	—	—	—	Fixed	—	—
V _{CCIO11}	—	—	—	—	—	—	Fixed	—	—
V _{CCIO12}	Default	Selectable	Selectable	Selectable	—	—	—	—	—
V _{CCIO13}	Fixed	—	—	—	—	—	—	—	—
V _{CCIO14}	Fixed	—	—	—	—	—	—	—	—

The Avant Evaluation Boards provide status LEDs to provide a visual indication of power status (Table 3.2).

Table 3.2. Status LED Definition

LED Designator	Color	Description
D1	Green	J2 USB connector
D61	Green	1.00 V power on
D62	Green	3.30 V power on
D63	Green	1.10 V power on
D64	Green	1.80 V power on
D65	Green	1.20 V power on
D66	Green	2.50 V power on
D67	Green	1.50 V power on
D68	Green	0.90 V power on
D69	Green	1.35 V power on
D70	Green	0.82 V to Avant V _{CC} and V _{CCCLK} power rails
D73	Green	5.00 V power on
D74	Green	12.00 V from external power source, J50
D75	Green	0.82 V to Avant VCCHP and VCCA_PLLx power rails

4. Programming

The JTAG/SPI programming architecture of the Avant Evaluation Board is shown in [Figure 4.1](#).

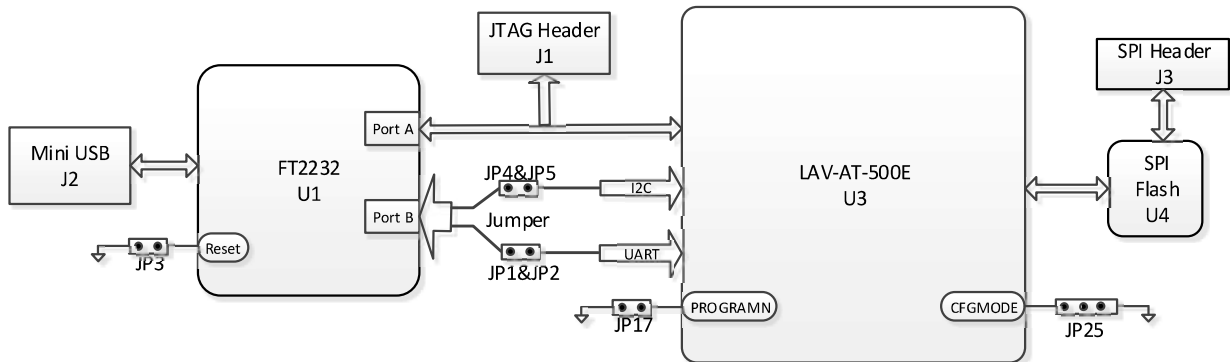

Figure 4.1. Configuration, UART and I²C Architecture

4.1. JTAG Download Interface

The Avant Evaluation Board has a built-in download controller for programming the Avant device. It uses FT2232H part of Future Technology Devices International Ltd. (FTDI) to convert USB to JTAG. To use the built-in download cable, connect the USB cable from a PC with Radiant Programmer installed to the mini USB connector (J2) on the board. A USB-A to USB-B (Mini) cable is included in the Avant Evaluation Board Kit. The USB hub on the PC detects the cable of the USB function on Port A, making the built-in cable available for use with the Radiant programming software.

4.2. Alternate JTAG Download Interface

J1 is a stand-alone eight-pin JTAG header that can be used with an external Lattice Programming Cable that is available separately. When the FTDI part is disabled from the JTAG chain by installing the JP3 jumper, the USB Programming Cable can be connected to J1 to interface with the Avant device. For details on the connection between the USB Programming Cable and J1, refer to [Programming Cables User Guide \(FPGA-UG-02042\)](#). J1 can also be used as test points when the configuration from USB to JTAG is working. The JTAG connections are listed in [Table 4.1](#).

Table 4.1. JTAG Connections

J1 Pin Number	JTAG Signal Name	Avant Bank	Avant Ball Location for JTAG
1	VCC_3V30	—	—
2	TDO	2	U2
3	TDI	2	U1
4	—	—	—
5	—	—	—
6	TMS	2	R1
7	GND	—	—
8	TCK	2	T1

4.3. SPI Flash Device Selection in Programmer

The on-board Flash device is Macronix MX25L51245G that powers up through the 3.3 V supply (Figure 4.2). The Flash device can be programmed with Radiant Programmer through the J3 header with the Lattice Programming Cable.

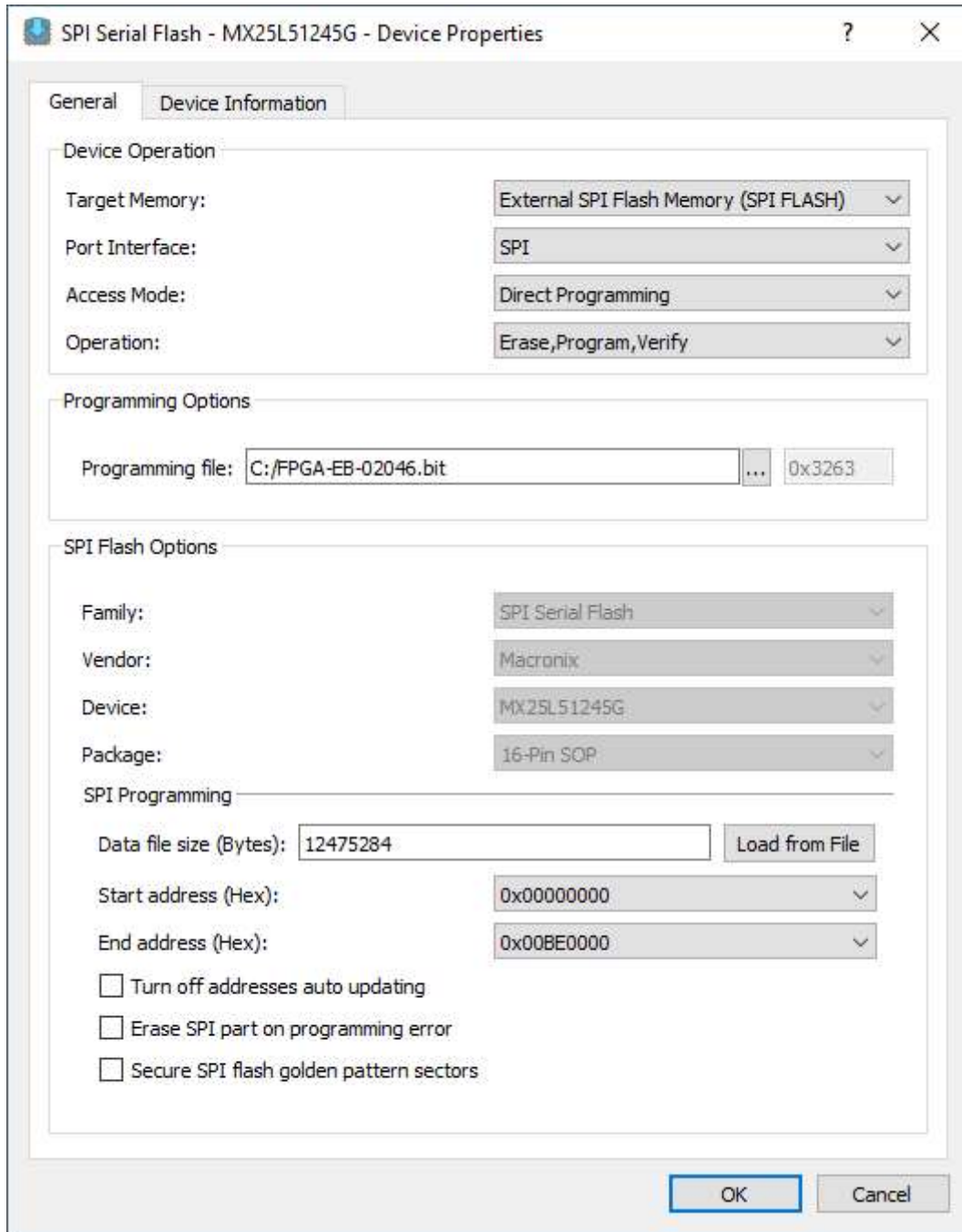

Figure 4.2. SPI Flash Operation Dialog

4.4. Global Setting in Lattice Radiant software

The Avant Evaluation Board has been downloaded with LED blinking project beforehand. Some **Global** settings in the **Device Constraint Editor** are configured. These settings are shown in [Figure 4.3](#), [Figure 4.4](#), and [Figure 4.5](#).

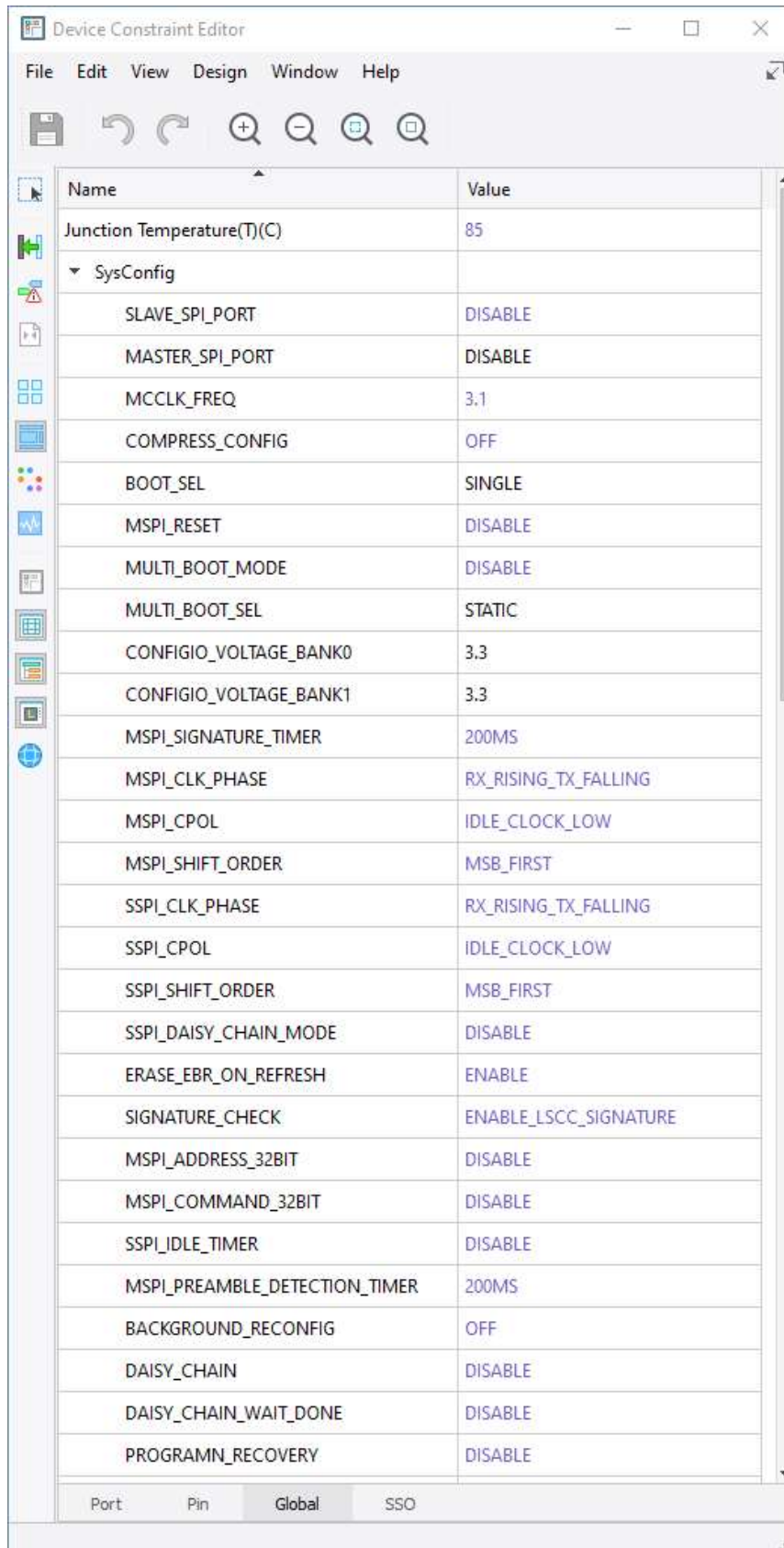

Figure 4.3. Global Settings (1)

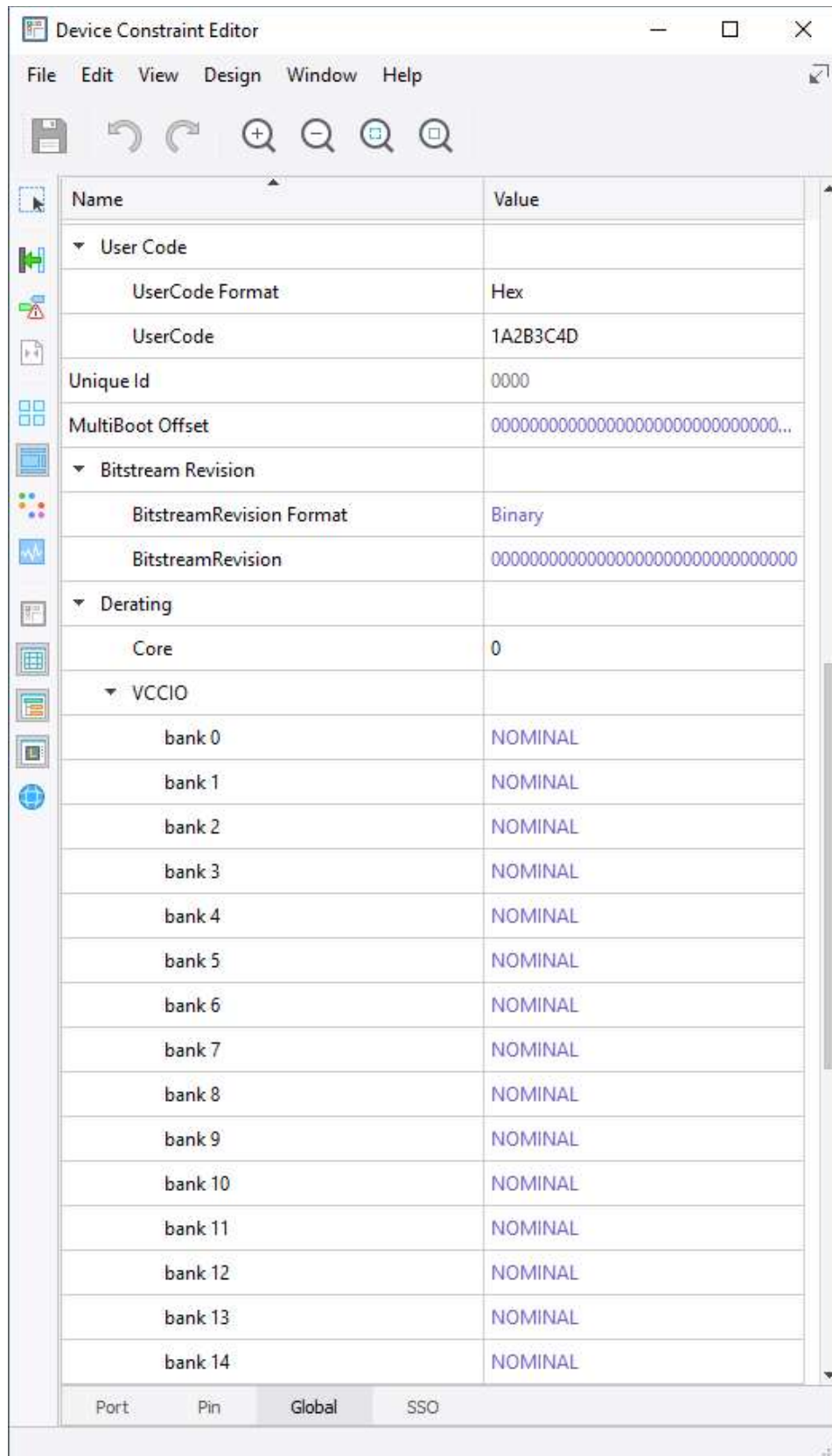

Figure 4.4. Global Settings (2)

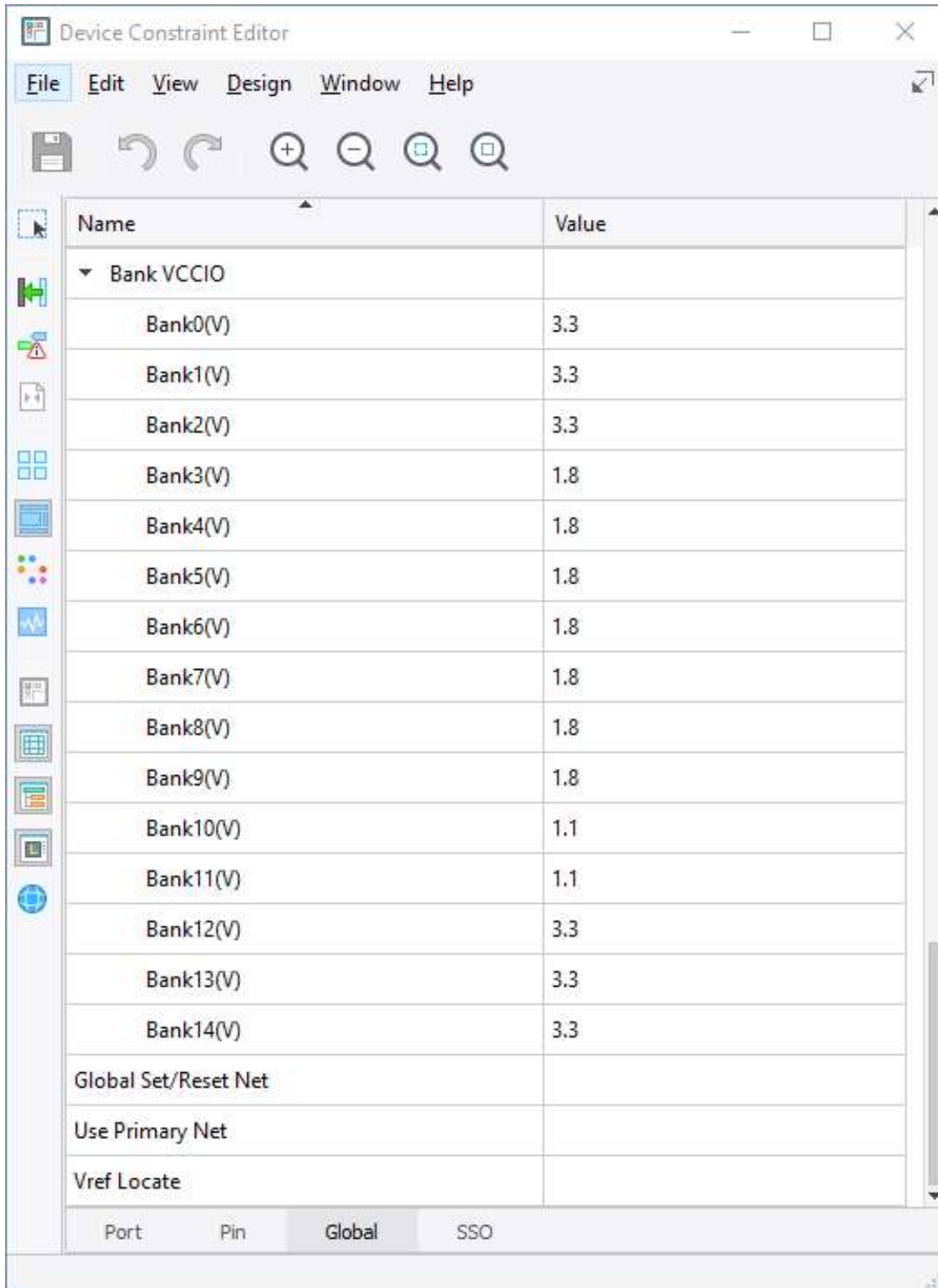

Figure 4.5. Global Settings (3)

4.5. Other Configuration Pins

The Avant Evaluation Board provides test points for other configuration pins, as shown in [Table 4.2](#).

Table 4.2. Other Configuration Signals

Signal Name	Avant Bank	Avant Ball Location	Test Point	Button/Jumper
PROGRAMN	2	P2	PROGRAMN	SW2/JP17
INITN	2	T5	INITN	—
DONE	2	U4	DONE	—
CFGMODE	2	P1	N/A	JP25

- **INITN:** Open drain pin. This signal is driven to LOW when the configuration sequence is started, indicating the device is in initialization state. At this moment, the LED (D4) is lighted with red color. This signal is released after initialization is completed, and the configuration download starts.
- **DONE:** Open drain pin. This signal is driven to LOW during configuration time. This signal releasing indicates the device has completed configuration. At this moment, the LED (D5) is lighted with green color.

For more information on Avant JTAG and SPI programming, refer to [Lattice Avant sysCONFIG User Guide \(FPGA-TN-02299\)](#).

5. Avant Clock Sources

The Avant Evaluation Board has two options for the Avant clock sources, as shown in [Table 5.1](#).

Table 5.1. Clock Sources

Clock Frequency (MHz)	Signal Name	Avant Bank	Avant Ball Location	Clock Source	Comments
12	12_MHz	2	U3	X1	JP6 is installed and JP65 set to 2-3.
100	F_DDR_100MHz_P/N	10	AA34/ AA33	Y1	HCSL differential output

6. Control Buses – I²C, UART, and SPI

This section describes the topology of the various configuration and communication buses.

6.1. I²C Topology

The Avant Evaluation Board has four sets of I²C buses. One I²C bus is through the output port B of the FTDI chip. The second I²C bus is out of Bank 6 to a header. There is an I²C bus for each of the FMC connectors. The I²C connections are summarized in [Table 6.1](#).

Table 6.1. I²C Bus Connections

Signal Name	Avant Bank	Avant Ball Location	Other Connection	Comments
SCL	14	R12	U1.38	R103 and JP4 need to be inserted.
SDA	14	T11	U1.39 & U1.40	R104 and JP5 need to be inserted.
B6_SCL	6	AH16	JP64.3	Debug Header
B6_SDA	6	AG16	JP64.1	Debug Header
FMC1_SCL	0	T8	J48.C30 & J10.10	FMC Header and Debug Header
FMC1_SDA	0	U8	J48.C31 & J10.14	FMC Header and Debug Header
FMC2_SCL	13	R15	J54.C30 & J53.10	FMC Header and Debug Header
FMC2_SDA	13	R14	J54.C31 & J53.14	FMC Header and Debug Header

6.2. UART Topology

The board provides one UART communication interface by providing a flexible connection between the Avant device and FTDI chip. Close the two jumpers, JP1 and JP2, to connect to two general-purpose I/O in Bank 2, as shown in [Table 6.2](#). This UART connection is shared with the I²C bus connection on the FTDI device.

Table 6.2. UART Bus Connections

Signal Name	Avant Bank	Avant Ball Location	FTDI Chip Ball Location	Jumper
TXD_UART	2	T3	38	JP1
RXD_UART	2	R3	39	JP2

6.3. SPI Topology

6.3.1. SPI Configuration

One of the major functions of SPI connections on the board is to support Avant configuration from the SPI Flash or the Parallel Configuration Header (J3), as shown in [Table 6.3](#). The Avant Evaluation Board can support both Master SPI (MSPI) and Slave SPI (SSPI) modes for Avant configuration. Jumper JP51 selects chip select connection to flash (U4), either from Avant or Header J3.

Table 6.3. SPI Bus Connections

Signal Name	Avant Bank	Avant Ball	Parallel Configuration Header Pin
SPI_MCLK	1	P9	12
DQ0_MOSI	1	L12	5
DQ1_MISO	1	L11	7
CSSPIN	1	P7	8
DQ2	1	L10	11
DQ3	1	L9	9
FLASH_CS	N/A	N/A	2

7. LEDs, Switches and Segment Displays

This section describes the Avant Evaluation Board LEDs, switches and segment displays that can be used in demo and customer designs.

7.1. DIP Switch

Eight Avant pins are connected to the DIP switch (SW3) to allow manual actuating input to the FPGA. One side of each switch is connected to GPIOs within Bank 6, and is pulled up through 4.7 kΩ resistors. The other side is grounded. The designated pins are connected as shown in [Table 7.1](#).

Table 7.1. DIP Switch Signals

Signal Name	Avant Ball Location	Avant Bank
DIP_SW1	AA16	6
DIP_SW2	AA17	6
DIP_SW3	AL16	6
DIP_SW4	AM16	6
DIP_SW5	AB16	6
DIP_SW6	AB17	6
DIP_SW7	AP16	6
DIP_SW8	AN16	6

7.2. General Purpose Push Buttons

The Avant Evaluation Board provides four push button switches, SW1, SW2, SW4 and SW5, for demo and user applications. One of the buttons is a pre-defined functional pin, and the other three are generic pins. Pressing these buttons drives a logic level “0” to the corresponding I/O pins. The designated pins are connected as shown in [Table 7.2](#).

Table 7.2. Push Button Switch Signals

Signal Name	Avant Bank	Avant Ball Location	Push Button Reference	Logic Level at Button Pressed
PROGRAMN	1	P2	SW2	0
PUSHBUTTON1	6	AC17	SW1	0
PUSHBUTTON2	6	AC16	SW4	0
PUSHBUTTON3	6	AP15	SW5	0

For more information on PROGRAMN, refer to [Lattice Avant sysCONFIG User Guide \(FPGA-TN-02299\)](#). SW2, SW4, and SW5 can be used as generic input.

7.3. General Purpose LEDs

The Avant Evaluation Board provides 16 LEDs that are connected to I/O within Banks 1 and 6. The LEDs are either green or red, as shown in [Table 7.3](#).

Table 7.3. General Purpose LED Signals

Signal Name	Avant Ball Location	Avant Bank	LED	Avant Color
LED_0	N7	1	D6	Green
LED_1	L7	1	D7	Green
LED_2	L8	1	D8	Green
LED_3	P8	1	D9	Green
LED_4	M8	1	D10	Green
LED_5	M9	1	D11	Green
LED_6	P10	1	D12	Green
LED_7	N10	1	D13	Green
LED_8	AN15	6	D22	Red
LED_9	AH17	6	D23	Red
LED_10	AG17	6	D24	Red
LED_11	AM14	6	D25	Red
LED_12	AL14	6	D26	Red
LED_13	AK17	6	D27	Red
LED_14	AJ17	6	D28	Red
LED_15	AN14	6	D29	Red

7.4. Segment Displays

The Avant Evaluation Board provides a 3-Character, 7-Segment LED display (D60) that is connected to I/O within Bank 14. The designated pins are connected as shown in [Table 7.4](#).

Table 7.4. Segment Display

Signal Name	Avant Ball Location	Avant Bank	Segment Display
SEG_A	V10	14	A
SEG_B	T10	14	B
SEG_C	V12	14	C
SEG_D	V13	14	D
SEG_E	W10	14	E
SEG_F	V11	14	F
SEG_G	W12	14	G
SEG_DP	W11	14	DP
K_DIG1	W9	14	K_DIG1
K_DIG2	V9	14	K_DIG2
K_DIG3	R10	14	K_DIG3

8. Headers/Connectors and Avant Device Ball Mapping

This section describes the Avant Evaluation Board headers/connectors and ball mapping.

8.1. FMC1 Connector

Table 8.1. FMC1 Pin Connections

J48 Pin Name	Signal Name	Avant Bank	Avant Ball Location
B1	FMC1_RES1	0	V5
B40	FMC1_RES0	0	W5
C10	FMC1_LA06_P	3	Y8
C11	FMC1_LA06_N	3	Y9
C14	FMC1_LA10_P	3	AC13
C15	FMC1_LA10_N	3	AC12
C18	FMC1_LA14_P	3	AC4
C19	FMC1_LA14_N	3	AC5
C22	FMC1_LA18_CLK_P	5	AN7
C23	FMC1_LA18_CLK_N	5	AP7
C26	FMC1_LA27_P	3	AB10
C27	FMC1_LA27_N	3	AC10
C30	FMC1_SCL	0	T8
C31	FMC1_SDA	0	U8
C34	FMC1_GA0	—	—
D1	FMC1_PG_C2M	0	V4
D8	FMC1_LA01_CLK_P	3	AB1
D9	FMC1_LA01_CLK_N	3	AC1
D11	FMC1_LA05_P	3	AA8
D12	FMC1_LA05_N	3	AA9
D14	FMC1_LA09_P	3	AD12
D15	FMC1_LA09_N	3	AD11
D17	FMC1_LA13_P	3	AA3
D18	FMC1_LA13_N	3	Y3
D20	FMC1_LA17_CLK_P	3	AC8
D21	FMC1_LA17_CLK_N	3	AC9
D23	FMC1_LA23_P	3	AD9
D24	FMC1_LA23_N	3	AD10
D26	FMC1_LA26_P	5	AG12
D27	FMC1_LA26_N	5	AG13
D29	FMC1_TCK	0	T7
D30	FMC1_TDI	0	W1
D31	FMC1_TDO	0	V1
D33	FMC1_TMS	0	W7
D34	FMC1_TRST_L	—	—
D35	FMC1_GA1	—	—
E2	FMC1_HA01_CLK_P	4	AH1
E3	FMC1_HA01_CLK_N	4	AJ1
E6	FMC1_HA05_P	4	AE5
E7	FMC1_HA05_N	4	AF5
E9	FMC1_HA09_P	4	AE2

J48 Pin Name	Signal Name	Avant Bank	Avant Ball Location
E10	FMC1_HA09_N	4	AF2
E12	FMC1_HA13_P	4	AJ4
E13	FMC1_HA13_N	4	AK4
E15	FMC1_HA16_P	4	AM4
E16	FMC1_HA16_N	4	AL4
E18	FMC1_HA20_P	4	AF9
E19	FMC1_HA20_N	4	AE9
F1	FMC1_PG_M2C	0	W4
F4	FMC1_HA00_CLK_P	4	AF6
F5	FMC1_HA00_CLK_N	4	AE6
F7	FMC1_HA04_P	4	AE4
F8	FMC1_HA04_N	4	AF4
F10	FMC1_HA08_P	4	AG1
F11	FMC1_HA08_N	4	AG2
F13	FMC1_HA12_P	4	AJ2
F14	FMC1_HA12_N	4	AK2
F16	FMC1_HA15_P	4	AE11
F17	FMC1_HA15_N	4	AF11
F19	FMC1_HA19_P	4	AF10
F20	FMC1_HA19_N	4	AE10
G2	FMC1_CLK1_M2C_P	4	AP2
G3	FMC1_CLK1_M2C_N	4	AP3
G6	FMC1_LA00_CLK_P	3	Y7
G7	FMC1_LA00_CLK_N	3	Y6
G9	FMC1_LA03_P	3	AD6
G10	FMC1_LA03_N	3	AD5
G12	FMC1_LA08_P	3	AA2
G13	FMC1_LA08_N	3	Y2
G15	FMC1_LA12_P	3	AB4
G16	FMC1_LA12_N	3	AB5
G18	FMC1_LA16_P	3	AC3
G19	FMC1_LA16_N	3	AC2
G21	FMC1_LA20_P	3	AD3
G22	FMC1_LA20_N	3	AD4
G24	FMC1_LA22_P	5	AC15
G25	FMC1_LA22_N	5	AC14
G27	FMC1_LA25_P	5	AH10
G28	FMC1_LA25_N	5	AJ10
G30	FMC1_LA29_P	5	AK9
G31	FMC1_LA29_N	5	AK8
G33	FMC1_LA31_P	5	AM8
G34	FMC1_LA31_N	5	AM9
G36	FMC1_LA33_P	5	AN9
G37	FMC1_LA33_N	5	AN8
H1	FMC1_VREFA	3/4/5	AA11/AG6/AF13
H2	FMC1_PRSNT_M2C_L	0	U7
H4	FMC1_CLK0_M2C_P	4	AF1
H5	FMC1_CLK0_M2C_N	4	AE1

J48 Pin Name	Signal Name	Avant Bank	Avant Ball Location
H7	FMC1_LA02_P	3	AC7
H8	FMC1_LA02_N	3	AC6
H10	FMC1_LA04_P	3	Y11
H11	FMC1_LA04_N	3	Y10
H13	FMC1_LA07_P	3	AB13
H14	FMC1_LA07_N	3	AB12
H16	FMC1_LA11_P	3	AA4
H17	FMC1_LA11_N	3	Y4
H19	FMC1_LA15_P	3	AD2
H20	FMC1_LA15_N	3	AD1
H22	FMC1_LA19_P	3	AD7
H23	FMC1_LA19_N	3	AD8
H25	FMC1_LA21_P	5	AE14
H26	FMC1_LA21_N	5	AF14
H28	FMC1_LA24_P	5	AK10
H29	FMC1_LA24_N	5	AK11
H31	FMC1_LA28_P	5	AL8
H32	FMC1_LA28_N	5	AL9
H34	FMC1_LA30_P	5	AN6
H35	FMC1_LA30_N	5	AN5
H37	FMC1_LA32_P	5	AP9
H38	FMC1_LA32_N	5	AP8
J2	FMC1_CLK3_M2C_P	5	AJ12
J3	FMC1_CLK3_M2C_N	5	AJ11
J6	FMC1_HA03_P	4	AE7
J7	FMC1_HA03_N	4	AF7
J9	FMC1_HA07_P	4	AH4
J10	FMC1_HA07_N	4	AH3
J12	FMC1_HA11_P	4	AN1
J13	FMC1_HA11_N	4	AM1
J15	FMC1_HA14_P	4	AM3
J16	FMC1_HA14_N	4	AN3
J18	FMC1_HA18_P	4	AG7
J19	FMC1_HA18_N	4	AG8
J21	FMC1_HA22_P	5	AA15
J22	FMC1_HA22_N	5	AA14
K4	FMC1_CLK2_M2C_P	3	AB7
K5	FMC1_CLK2_M2C_N	3	AA7
K7	FMC1_HA02_P	4	AF3
K8	FMC1_HA02_N	4	AE3
K10	FMC1_HA06_P	4	AL1
K11	FMC1_HA06_N	4	AK1
K13	FMC1_HA10_P	4	AN4
K14	FMC1_HA10_N	4	AP4
K16	FMC1_HA17_CLK_P	5	AF12
K17	FMC1_HA17_CLK_N	5	AE12
K19	FMC1_HA21_P	4	AH6
K20	FMC1_HA21_N	4	AH5

J48 Pin Name	Signal Name	Avant Bank	Avant Ball Location
K22	FMC1_HA23_P	5	AB14
K23	FMC1_HA23_N	5	AB15

8.2. FMC2 Connector

Table 8.2. FMC2 Pin Connections

J54 Pin Name	Signal Name	Avant Bank	Avant Ball Location
B1	FMC2_RES1	13	R18
B40	FMC2_RES0	13	R19
C10	FMC2_LA06_P	7	AL20
C11	FMC2_LA06_N	7	AM20
C14	FMC2_LA10_P	7	Y17
C15	FMC2_LA10_N	7	Y18
C18	FMC2_LA14_P	7	AF19
C19	FMC2_LA14_N	7	AF20
C22	FMC2_LA18_CLK_P	8	AN28
C23	FMC2_LA18_CLK_N	8	AM28
C26	FMC2_LA27_P	7	AM23
C27	FMC2_LA27_N	7	AL23
C30	FMC2_SCL	13	R15
C31	FMC2_SDA	13	R14
C34	FMC2_GA0	—	—
D1	FMC2_PG_C2M	13	T18
D8	FMC2_LA01_CLK_P	7	AG20
D9	FMC2_LA01_CLK_N	7	AH20
D11	FMC2_LA05_P	7	AN18
D12	FMC2_LA05_N	7	AP18
D14	FMC2_LA09_P	7	AD17
D15	FMC2_LA09_N	7	AE17
D17	FMC2_LA13_P	7	AE18
D18	FMC2_LA13_N	7	AE19
D20	FMC2_LA17_CLK_P	7	AP22
D21	FMC2_LA17_CLK_N	7	AN22
D23	FMC2_LA23_P	7	AK21
D24	FMC2_LA23_N	7	AA10
D26	FMC2_LA26_P	8	AK28
D27	FMC2_LA26_N	8	AK27
D29	FMC2_TCK	13	U15
D30	FMC2_TDI	13	U16
D31	FMC2_TDO	13	U17
D33	FMC2_TMS	13	W14
D34	FMC2_TRST_L	—	—
D35	FMC2_GA1	—	—
E2	FMC2_HA01_CLK_P	9	AG33
E3	FMC2_HA01_CLK_N	9	AH33
E6	FMC2_HA05_P	9	AH30
E7	FMC2_HA05_N	9	AJ30

J54 Pin Name	Signal Name	Avant Bank	Avant Ball Location
E9	FMC2_HA09_P	9	AK31
E10	FMC2_HA09_N	9	AK32
E12	FMC2_HA13_P	9	AN32
E13	FMC2_HA13_N	9	AP32
E15	FMC2_HA16_P	9	AL33
E16	FMC2_HA16_N	9	AL34
E18	FMC2_HA20_P	9	AJ31
E19	FMC2_HA20_N	9	AJ32
E21	FMC2_HB03_P	8	AD19
E22	FMC2_HB03_N	8	AD20
E24	FMC2_HB05_P	8	AG21
E25	FMC2_HB05_N	8	AF21
E27	FMC2_HB09_P	8	AG23
E28	FMC2_HB09_N	8	AG24
E30	FMC2_HB13_P	8	AN24
E31	FMC2_HB13_N	8	AP24
E33	FMC2_HB19_P	8	AM26
E34	FMC2_HB19_N	8	AM25
E36	FMC2_HB21_P	8	AL26
E37	FMC2_HB21_N	8	AK26
F1	FMC2_PG_M2C	13	T19
F4	FMC2_HA00_CLK_P	9	AM30
F5	FMC2_HA00_CLK_N	9	AL30
F7	FMC2_HA04_P	9	AH26
F8	FMC2_HA04_N	9	AG26
F10	FMC2_HA08_P	9	AP31
F11	FMC2_HA08_N	9	AN31
F13	FMC2_HA12_P	9	AN34
F14	FMC2_HA12_N	9	AN33
F16	FMC2_HA15_P	9	AK33
F17	FMC2_HA15_N	9	AK34
F19	FMC2_HA19_P	9	AH34
F20	FMC2_HA19_N	9	AG34
F22	FMC2_HB02_P	8	AJ23
F23	FMC2_HB02_N	8	AH23
F25	FMC2_HB04_P	8	AG25
F26	FMC2_HB04_N	8	AF25
F28	FMC2_HB08_P	8	AL29
F29	FMC2_HB08_N	8	AM29
F31	FMC2_HB12_P	8	AN25
F32	FMC2_HB12_N	8	AP25
F34	FMC2_HB16_P	8	AP26
F35	FMC2_HB16_N	8	AN26
F37	FMC2_HB20_P	8	AP29
F38	FMC2_HB20_N	8	AN29
G2	FMC2_CLK1_M2C_P	9	AP30
G3	FMC2_CLK1_M2C_N	9	AN30
G6	FMC2_LA00_CLK_P	7	AJ18

J54 Pin Name	Signal Name	Avant Bank	Avant Ball Location
G7	FMC2_LA00_CLK_N	7	AK18
G9	FMC2_LA03_P	7	AM18
G10	FMC2_LA03_N	7	AL18
G12	FMC2_LA08_P	7	AN20
G13	FMC2_LA08_N	7	AP20
G15	FMC2_LA12_P	7	AB18
G16	FMC2_LA12_N	7	AA18
G18	FMC2_LA16_P	7	AL17
G19	FMC2_LA16_N	7	AM17
G21	FMC2_LA20_P	7	AH21
G22	FMC2_LA20_N	7	AH22
G24	FMC2_LA22_P	8	AH24
G25	FMC2_LA22_N	8	AH25
G27	FMC2_LA25_P	7	AP21
G28	FMC2_LA25_N	7	AN21
G30	FMC2_LA29_P	8	AC20
G31	FMC2_LA29_N	8	AB20
G33	FMC2_LA31_P	8	AB19
G34	FMC2_LA31_N	8	AA19
G36	FMC2_LA33_P	8	AP28
G37	FMC2_LA33_N	8	AP27
H1	FMC2_VREFA	7/8/9	AF18/AF24/AF27
H2	FMC2_PRSNT_M2C_L	13	T15
H4	FMC2_CLK0_M2C_P	9	AJ27
H5	FMC2_CLK0_M2C_N	9	AJ26
H7	FMC2_LA02_P	7	AK20
H8	FMC2_LA02_N	7	AJ20
H10	FMC2_LA04_P	7	AN19
H11	FMC2_LA04_N	7	AP19
H13	FMC2_LA07_P	7	AM21
H14	FMC2_LA07_N	7	AL21
H16	FMC2_LA11_P	7	AJ22
H17	FMC2_LA11_N	7	AJ21
H19	FMC2_LA15_P	7	AH18
H20	FMC2_LA15_N	7	AG18
H22	FMC2_LA19_P	7	AK19
H23	FMC2_LA19_N	7	AJ19
H25	FMC2_LA21_P	9	AF30
H26	FMC2_LA21_N	9	AG30
H28	FMC2_LA24_P	7	AN23
H29	FMC2_LA24_N	7	AP23
H31	FMC2_LA28_P	9	AH29
H32	FMC2_LA28_N	9	AG29
H34	FMC2_LA30_P	8	Y20
H35	FMC2_LA30_N	8	AA20
H37	FMC2_LA32_P	8	AL27
H38	FMC2_LA32_N	8	AL28
J2	FMC2_CLK3_M2C_P	8	AE22

J54 Pin Name	Signal Name	Avant Bank	Avant Ball Location
J3	FMC2_CLK3_M2C_N	8	AE23
J6	FMC2_HA03_P	9	AG27
J7	FMC2_HA03_N	9	AG28
J9	FMC2_HA07_P	9	AJ28
J10	FMC2_HA07_N	9	AJ29
J12	FMC2_HA11_P	9	AM32
J13	FMC2_HA11_N	9	AM31
J15	FMC2_HA14_P	9	AJ34
J16	FMC2_HA14_N	9	AJ33
J18	FMC2_HA18_P	9	AG32
J19	FMC2_HA18_N	9	AF32
J21	FMC2_HA22_P	8	AM24
J22	FMC2_HA22_N	8	AL24
J24	FMC2_HB01_P	5	AG10
J25	FMC2_HB01_N	5	AG11
J27	FMC2_HB07_P	5	AH9
J28	FMC2_HB07_N	5	AG9
J30	FMC2_HB11_P	5	AK7
J31	FMC2_HB11_N	5	AJ7
J33	FMC2_HB15_P	5	AP5
J34	FMC2_HB15_N	5	AP6
J36	FMC2_HB18_P	5	AL5
J37	FMC2_HB18_N	5	AL6
K1	FMC2_VREFB	5/8	AE13/AF23
K4	FMC2_CLK2_M2C_P	7	AP17
K5	FMC2_CLK2_M2C_N	7	AN17
K7	FMC2_HA02_P	9	AF28
K8	FMC2_HA02_N	9	AF29
K10	FMC2_HA06_P	9	AK29
K11	FMC2_HA06_N	9	AK30
K13	FMC2_HA10_P	9	AM33
K14	FMC2_HA10_N	9	AM34
K16	FMC2_HA17_CLK_P	8	AK24
K17	FMC2_HA17_CLK_N	8	AK23
K19	FMC2_HA21_P	9	AF31
K20	FMC2_HA21_N	9	AG31
K22	FMC2_HA23_P	8	AK25
K23	FMC2_HA23_N	8	AL25
K25	FMC2_HB00_P_CC	8	AE20
K26	FMC2_HB00_N_CC	8	AE21
K28	FMC2_HB06_P_CC	5	AH7
K29	FMC2_HB06_N_CC	5	AH8
K31	FMC2_HB10_P	5	AJ5
K32	FMC2_HB10_N	5	AJ6
K34	FMC2_HB14_P	5	AM6
K35	FMC2_HB14_N	5	AM5
K37	FMC2_HB17_P_CC	5	AK5
K38	FMC2_HB17_N_CC	5	AK6

8.3. Parallel FMC1 Configuration Header

Table 8.3. Parallel FMC1 Configuration Header Pin Connections

J10 Pin Name	Signal Name	Avant Bank	Avant Ball Location
1	VCC_3V30	—	—
2	VCC_3V30	—	—
3	FMC1_TCK	0	T7
4	FMC1_PG_C2M	0	V4
5	FMC1_PG_M2C	0	W4
6	FMC1_TRST_L	—	—
7	FMC1_TDI	0	W1
8	FMC1_PRSNT_M2C_L	0	U7
9	FMC1_TDO	0	V1
10	FMC1_SCL	0	T8
11	GND	—	—
12	GND	—	—
13	FMC1_TMS	0	W7
14	FMC1_SDA	0	U8

8.4. Parallel FMC2 Configuration Header

Table 8.4. Parallel FMC2 Configuration Header Pin Connections

J53 Pin Name	Signal Name	Avant Bank	Avant Ball Location
1	VCC_3V30	—	—
2	VCC_3V30	—	—
3	FMC2_TCK	13	U15
4	FMC2_PG_C2M	13	T18
5	FMC2_PG_M2C	13	T19
6	FMC2_TRST_L	—	—
7	FMC2_TDI	13	U16
8	FMC2_PRSNT_M2C_L	13	T15
9	FMC2_TDO	13	U17
10	FMC2_SCL	13	R15
11	GND	—	—
12	GND	—	—
13	FMC2_TMS	13	W14
14	FMC2_SDA	13	R14

8.5. Raspberry PI Board GPIO Header

The Avant Evaluation Board provides a 40-pin receptacle, which is compatible with the GPIO header of Raspberry PI 2/3 serial models, or can be used for general purpose I/O.

Table 8.5. Raspberry PI header Pin Connections

JP26 Pin Name	Signal Name	Avant Bank	Avant Ball Location
1	VCC_3V30 ¹	—	—
2	VCC_5V00 ¹	—	—
3	RASP_IO02	13	V15

JP26 Pin Name	Signal Name	Avant Bank	Avant Ball Location
4	VCC_5V00 ¹	—	—
5	RASP_IO03	13	T13
6	GND	—	—
7	RASP_IO04 ²	2	U3
8	RASP_IO14	13	V14
9	GND	—	—
10	RASP_IO15	13	R13
11	RASP_IO17	13	V16
12	RASP_IO18	14	T12
13	RASP_IO27	2	P3
14	GND	—	—
15	RASP_IO22	0	W6
16	RASP_IO23	2	P4
17	VCC_3V30 ¹	—	—
18	RASP_IO24	2	N5
19	RASP_IO10	2	R6
20	GND	—	—
21	RASP_IO09	2	R5
22	RASP_IO25	0	V2
23	RASP_IO11	14	U12
24	RASP_IO08	2	P5
25	GND	—	—
26	RASP_IO07	2	P6
27	RASP_ID_SD	14	T11
28	RASP_ID_SC	14	R12
29	RASP_IO05	14	V8
30	GND	—	—
31	RASP_IO06	14	W8
32	RASP_IO12	2	U5
33	RASP_IO13	14	R9
34	GND	—	—
35	RASP_IO19	14	R11
36	RASP_IO16	0	W2
37	RASP_IO26	14	T9
38	RASP_IO20	0	T6
39	GND	—	—
40	RASP_IO21	0	U6

Notes:

- 3.3 V and 5 V provide the power to the Raspberry PI board when JP12 and JP13 are installed. When JP12 and JP13 are not installed, Raspberry PI needs its own 3.3 V and 5 V power.
- When JP65 = 1-2

When connecting directly to a Raspberry PI board, depending on the individual setup, an adapter may need to avoid mechanical interference between the two boards. A generic 40-pin (2×20), 100-mil spacing header extender serves this function. Alternately, the two boards can be connected by a length of ribbon cable with 2×20 connectors on either end.

8.6. External Flash Configuration Header

Table 8.6. SPI Flash Configuration Header Pin Connections

J3 Pin Name	Signal Name	Avant Bank	Avant Ball Location
1	PROGRAMN	1	R8
2	FLASH_CS ¹	—	—
3	—	—	—
4	DONE	2	U4
5	DQ0_MOSI	1	L12
6	INITN	2	T5
7	DQ1_MISO	1	L11
8	CSSPIN	1	P7
9	DQ3	1	L9
10	VCCIO1_IN	—	—
11	DQ2	1	L10
12	SPI_MCLK	1	P9
13	GND	—	—
14	GND	—	—

Note:

1. Connected to Pin 1 of Flash (U4) device.

8.7. PMOD Header

J6 and J7 headers can be used as GPIOs or as a connector for PMOD interface.

Table 8.7. PMOD Header Pin Connections

	Pin Name	Signal Name	Avant Bank	Avant Ball Location	
J6	1	PMOD2_1	12	P18	
	2	PMOD2_2	12	N19	
	3	PMOD2_3	12	N20	
	4	PMOD2_4	12	P20	
	7	PMOD2_5	12	R17	
	8	PMOD2_6	12	M19	
	9	PMOD2_7	12	M20	
	10	PMOD2_8	12	P19	
	J7	1	PMOD3_1	12	P14
		2	PMOD3_2	12	N15
3		PMOD3_3	12	N16	
4		PMOD3_4	12	R16	
7		PMOD3_5	12	P13	
8		PMOD3_6	12	N14	
9		PMOD3_7	12	P15	
10		PMOD3_8	12	N17	

8.8. Through Hole Extended Area Header

Table 8.8. Through Hole Extended Area Header Pin Connections

Pin Name	Signal Name	Avant Bank	Avant Ball Location
TP_AN13	EPS1_AN13_P	6	AN13
TP_AP13	EPS1_AP13_N	6	AP13
TP_AJ16	EPS2_AJ16_P	6	AJ16
TP_AK16	EPS2_AK16_N	6	AK16
TP_AL13	EPS3_AL13_P	6	AL13
TP_AM13	EPS3_AM13_N	6	AM13
TP_AG15	EPS4_AG15_P	6	AG15
TP_AH15	EPS4_AH15_N	6	AH15
TP_AK13	EPS5_AK13_P	6	AK13
TP_AK12	EPS5_AK12_N	6	AK12
TP_AF15	EPS6_AF15_P	6	AF15
TP_AF16	EPS6_AF16_N	6	AF16
TP_AP12	EPS7_AP12_P	6	AP12
TP_AN12	EPS7_AN12_N	6	AN12
TP_AH14	EPS8_AH14_P	6	AH14
TP_AG14	EPS8_AG14_N	6	AG14
TP_AP10	EPS9_AP10_P	6	AP10
TP_AP11	EPS9_AP11_N	6	AP11
TP_AK14	EPS10_AK14_P	6	AK14
TP_AK15	EPS10_AK15_N	6	AK15
TP_AE15	EPS11_AE15_P	6	AE15
TP_AD15	EPS11_AD15_N	6	AD15
TP_AL10	EPS12_AL10_P	6	AL10
TP_AL11	EPS12_AL11_N	6	AL11
OV82	VCC_OV82	—	—
OV9	VCC_OV90	—	—
1V	VCC_1V00	—	—
1V1	VCC_1V10	—	—
1V2	VCC_1V20	—	—
1V35	VCC_1V35	—	—
1V5	VCC_1V50	—	—
1V8	VCC_1V80	—	—
2V5	VCC_2V50	—	—
3V3	VCC_3V30	—	—
F1_3V3	VFMC1_3V30	—	—
F2_3V3	VFMC2_3V30	—	—
F1_3V3AUX	VFMC1_3V30AUX	—	—
F2_3V3AUX	VFMC2_3V30AUX	—	—
F1_ADJ	VFMC1_ADJ	—	—
F2_ADJ	VFMC2_ADJ	—	—
5V	VCC_5V00	—	—
12V	VCC_12V00	—	—
GND6	GND	—	—
GND7	GND	—	—
GND8	GND	—	—

Pin Name	Signal Name	Avant Bank	Avant Ball Location
GND9	GND	—	—
GND10	GND	—	—
GND11	GND	—	—
GND12	GND	—	—
GND13	GND	—	—
GND14	GND	—	—
GND15	GND	—	—

9. Software Requirements

The following software versions are required to develop designs for the Avant Evaluation Board:

- Lattice Radiant Software 2022.1 or later
- Lattice Radiant Programmer 2022.1 or later

10. Storage and Handling

Static electricity can shorten the life span of electronic components. Observe these tips to prevent damage that can occur from electrostatic discharge:

- Use antistatic precautions such as operating on an antistatic mat and wearing an antistatic wristband.
- Store the development board in the provided packaging.
- Touch a metal USB housing to equalize voltage potential between you and the board.

11. Ordering Information

Table 11.1. Ordering Information

Description	Ordering Part Number	China RoHS Environment-Friendly Use Period (EFUP)
Avant Evaluation Board	LAV-500E-EVN	

Appendix A. Avant Evaluation Board Schematics

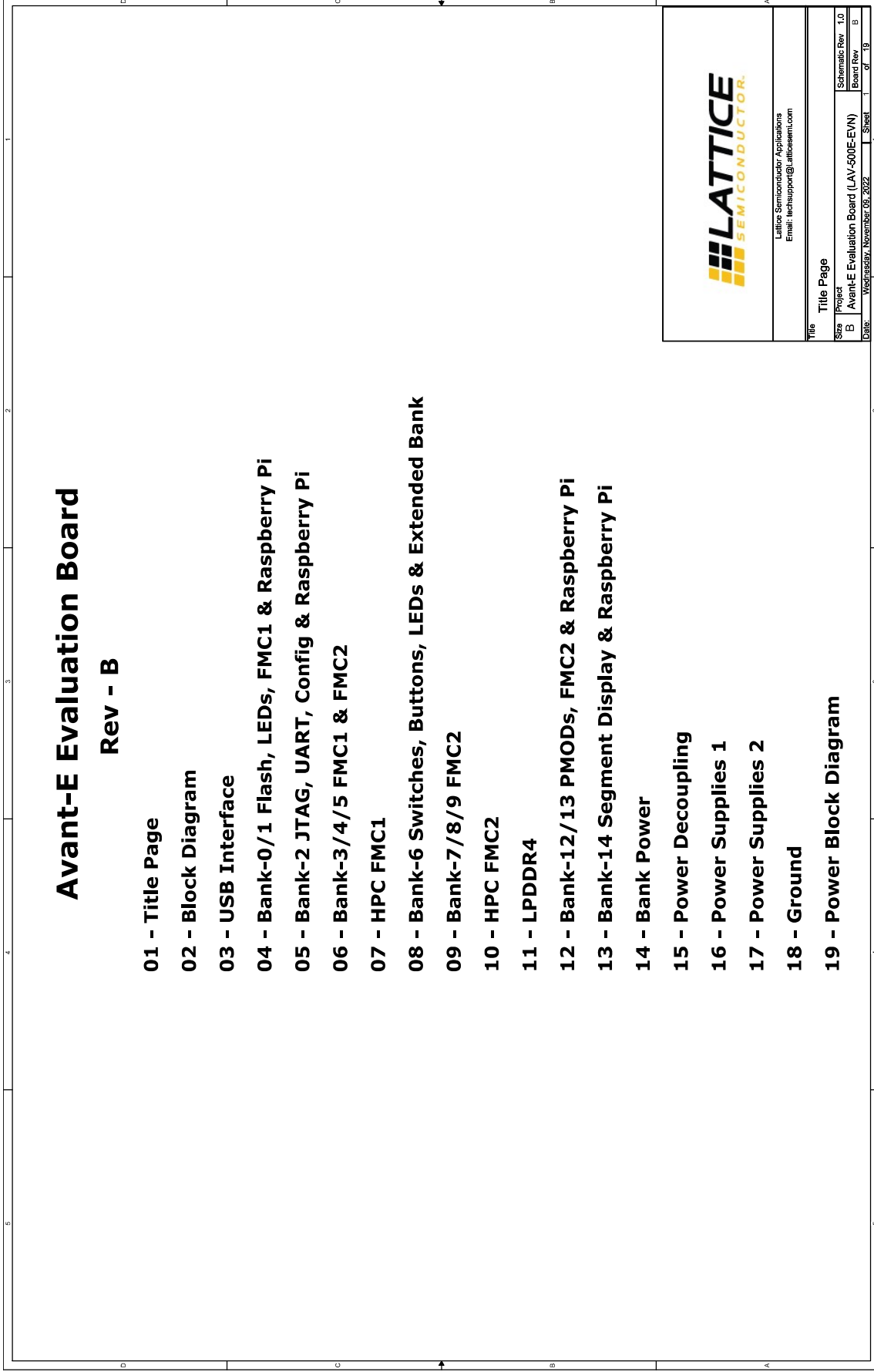

Figure A.1. Title Page

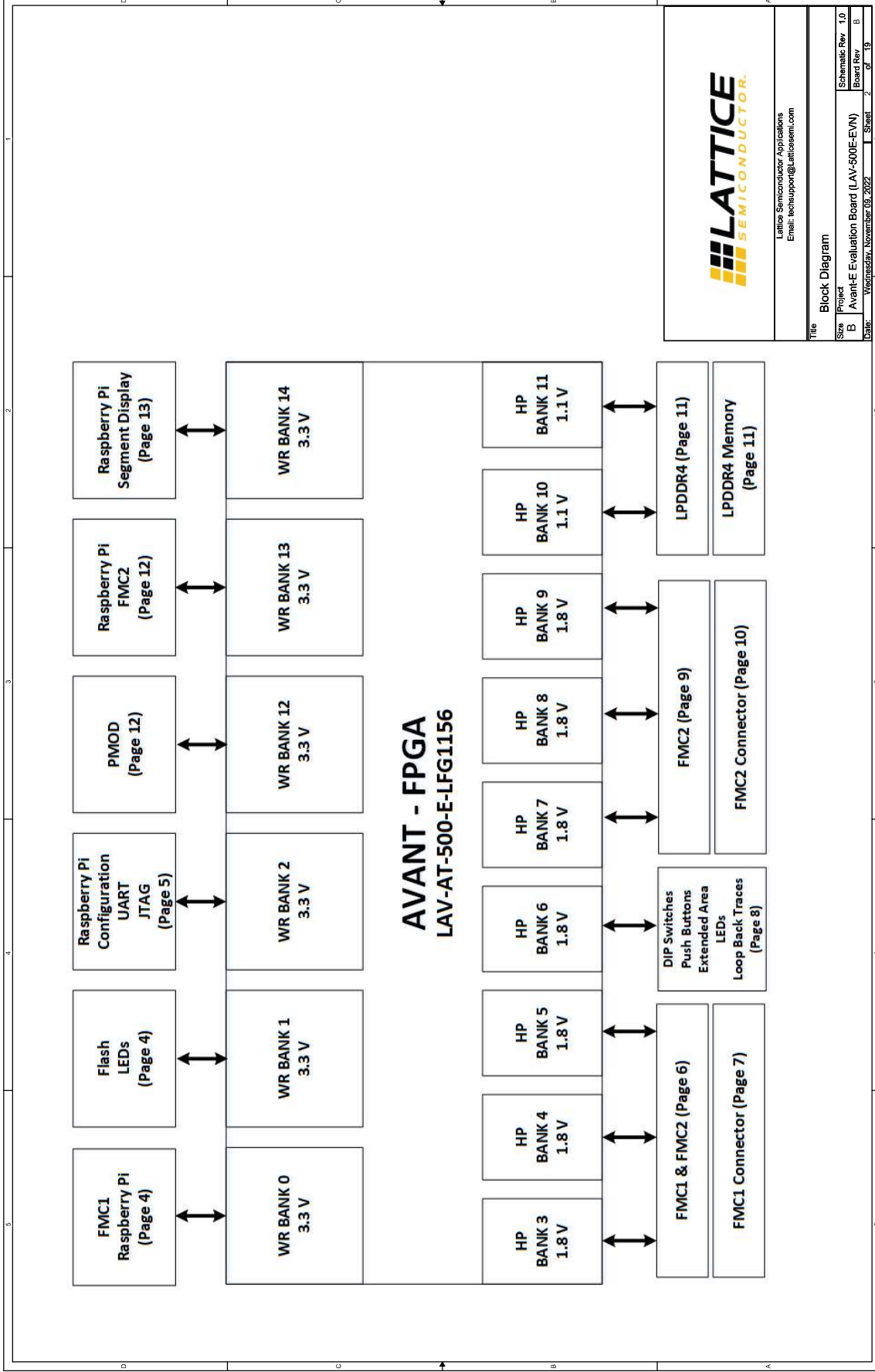
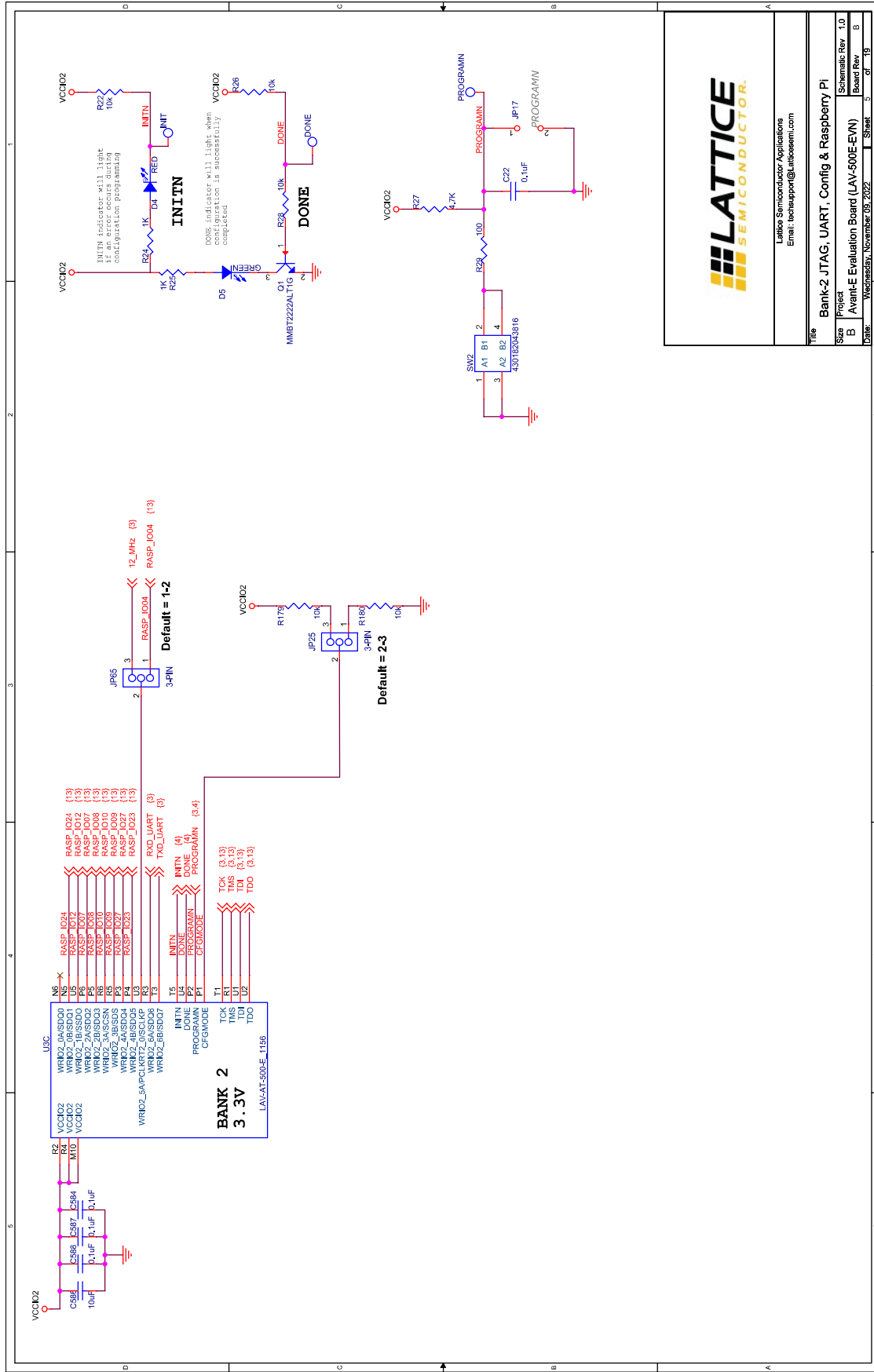

Figure A.2. Block Diagram



Lattice Semiconductor Applications
Email: techsupport@latticesemi.com

Title		Bank-2 JTAG, UART, Config & Raspberry Pi	
Size	Project	Schematic Rev	1.0
B	Avant-E Evaluation Board (LAV-500E-EVN)	Board Rev	B
Date	Wednesday, November 08, 2023	Sheet	5 of 19

Figure A.5. Bank-2 JTAG, UART, Config & Raspberry Pi

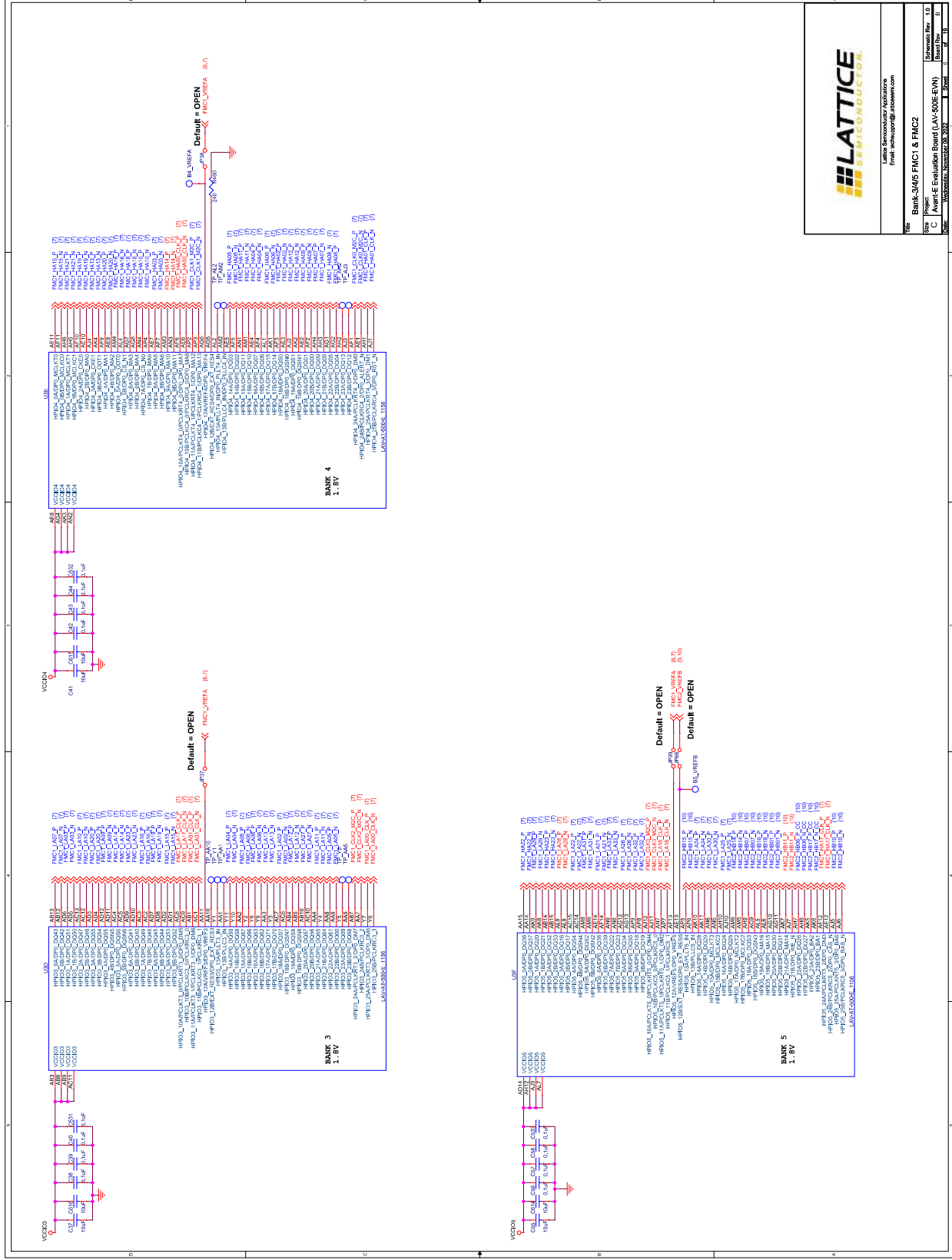

Figure A.6. Bank-3/4/5 FMC1 & FMC2

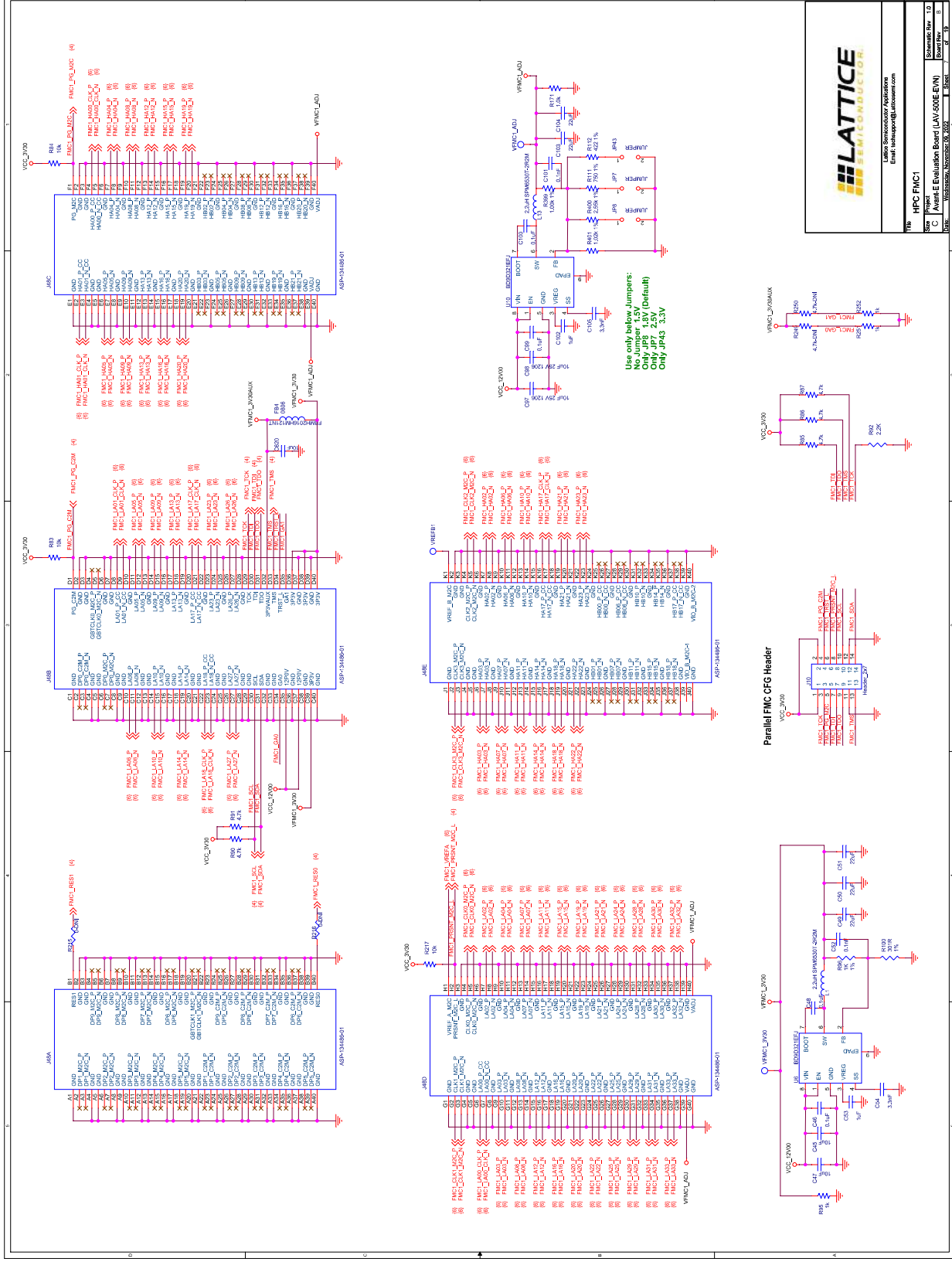
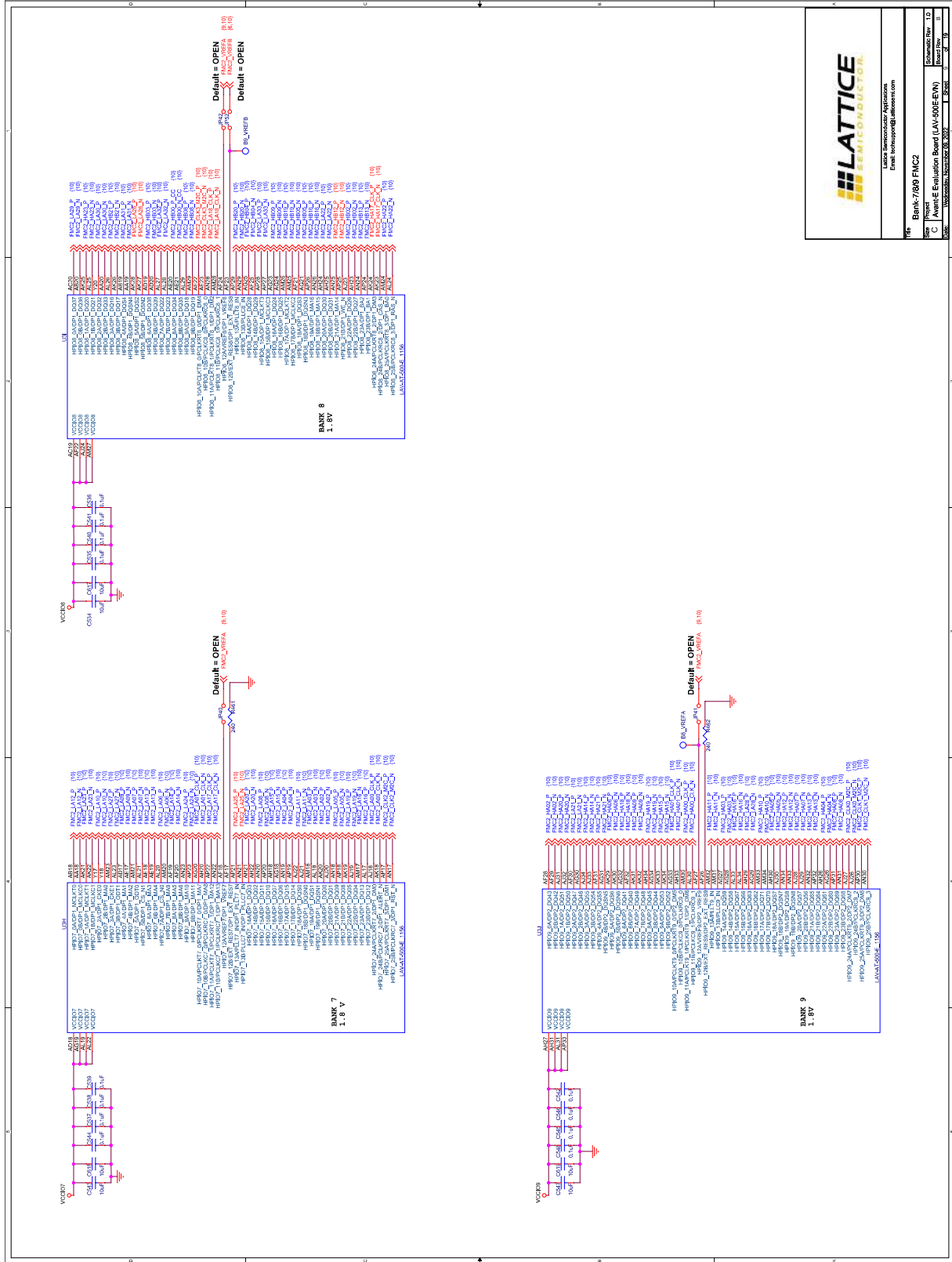

Figure A.7. HPC FMC1

© 2022-2023 Lattice Semiconductor Corp. All Lattice trademarks, registered trademarks, patents, and disclaimers are as listed at www.latticesemi.com/legal. All other brand or product names are trademarks or registered trademarks of their respective holders. The specifications and information herein are subject to change without notice.



Lattice Semiconductor Corporation
Email: tdmiller@lattice.com

Title	Bank-7/8/9 FMC2
Part	Avant-E Evaluation Board (LAV-500E-EVN)
Rev	1.0
Date	11/20/2023

Figure A.9. Bank-7/8/9 FMC2

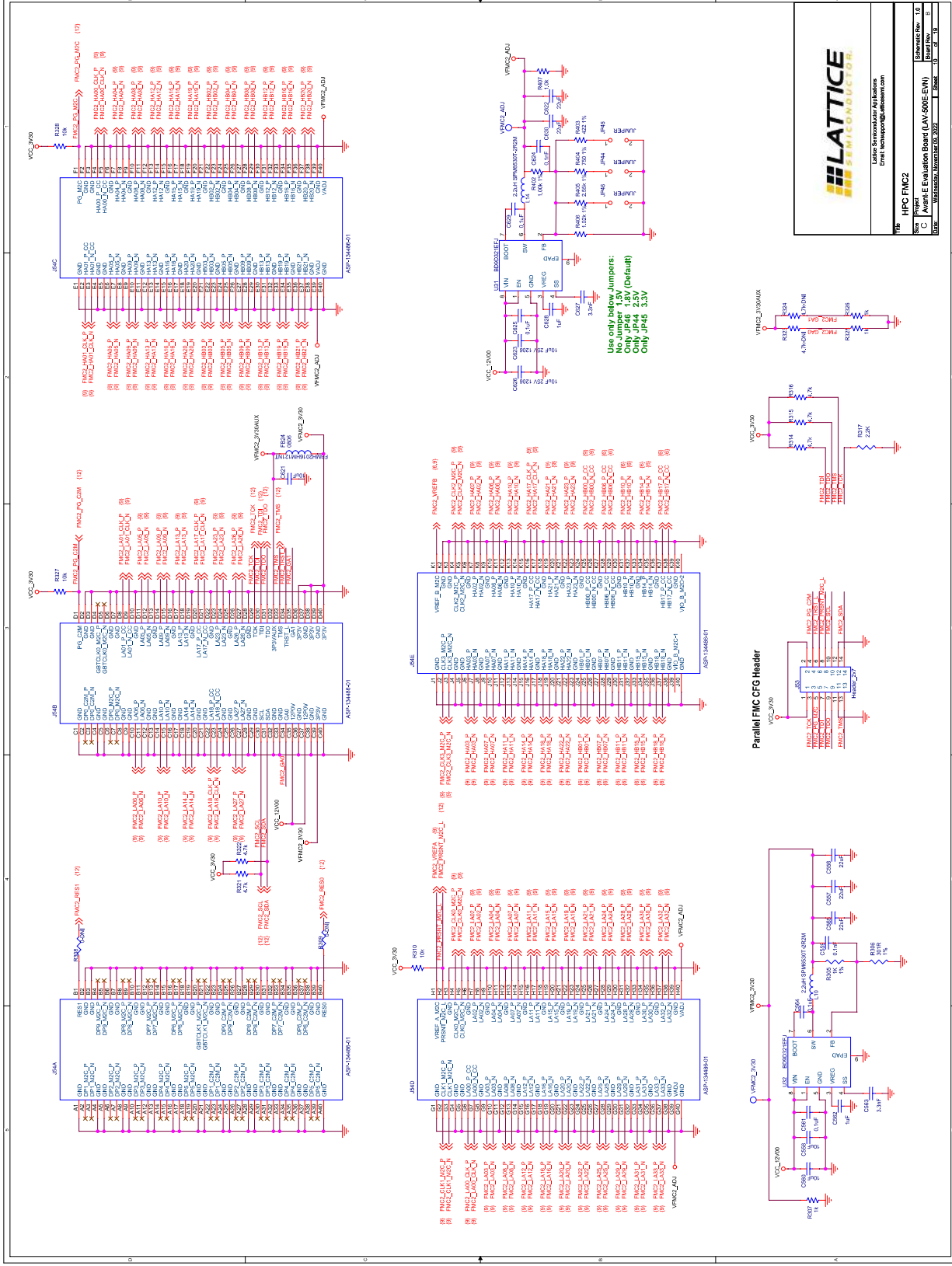

Figure A.10. HPC FMC2

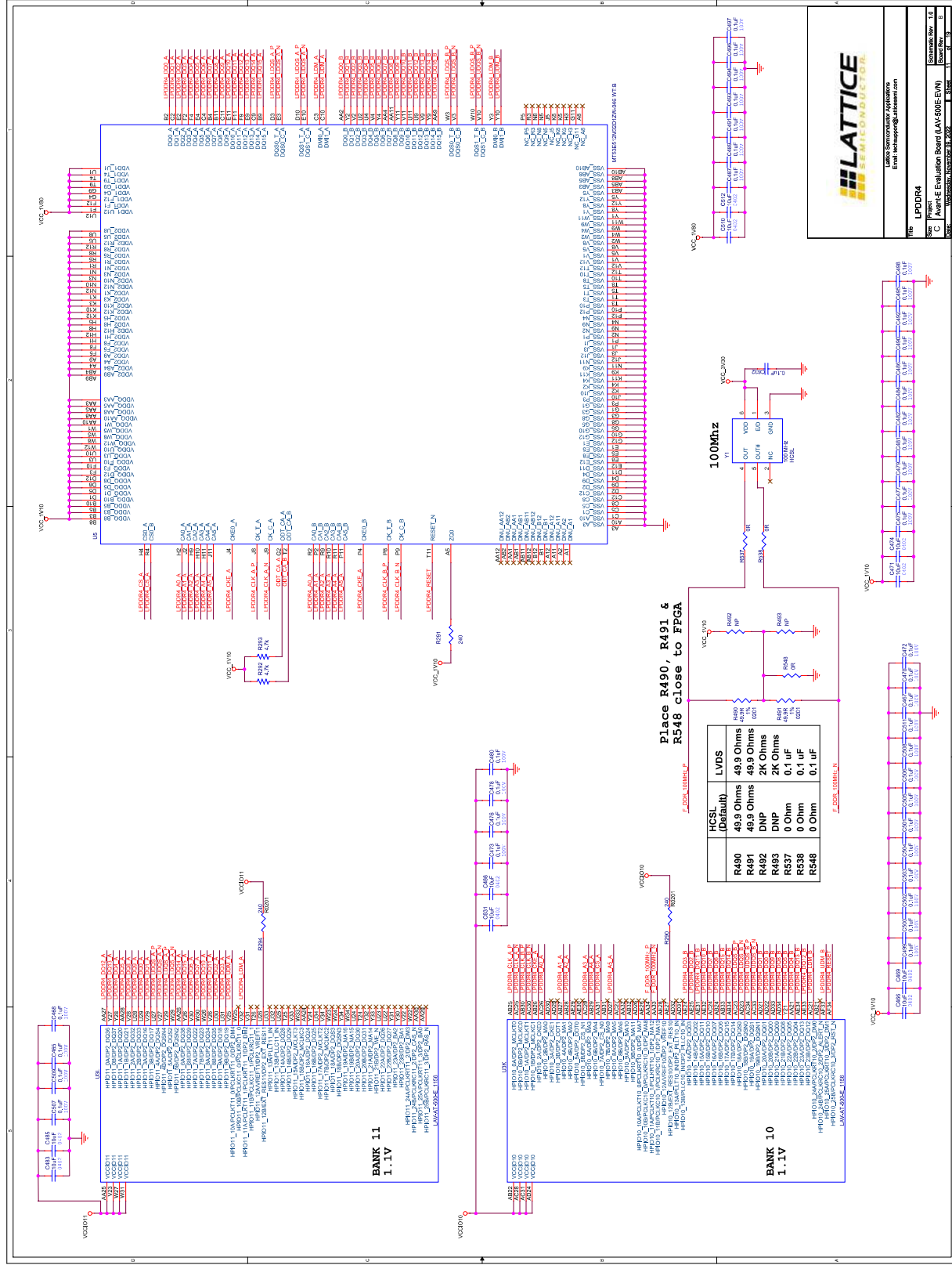
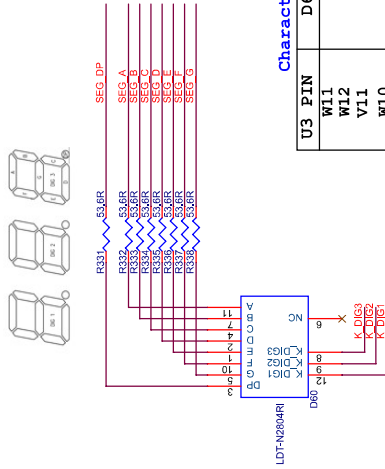
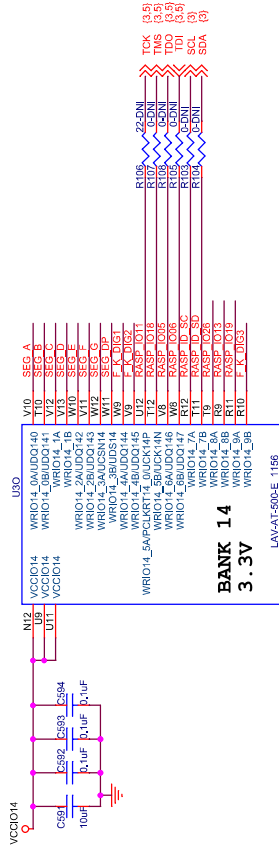
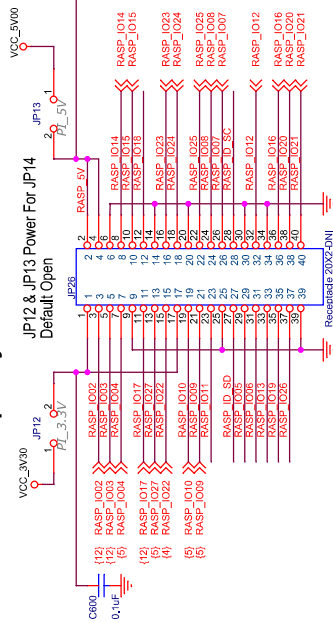

Figure A.11. LPDDR4

7_SEGMENT_DISPLAY_SECTION

Raspberry Pi and User I/O Connector



Character Signal Map

U3 PIN	D60 PIN	SEGMENT
V11	3	DP
V12	5	G
V10	1,0	F
V13	1	E
V12	2	D
T10	4	C
V10	7	B
V10	1,1	A

Figure A.13. Bank-14 Segment Display & Raspberry Pi

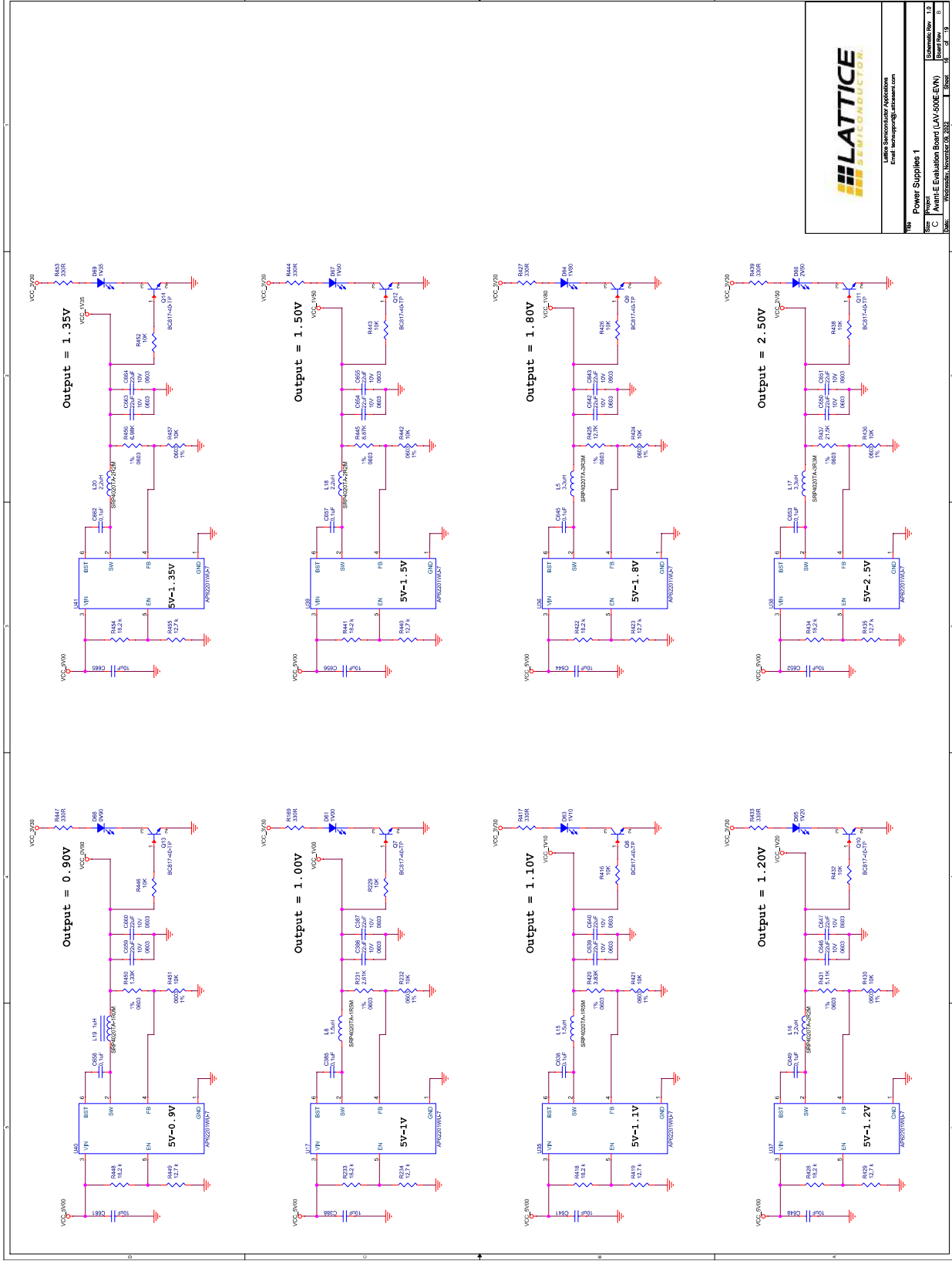
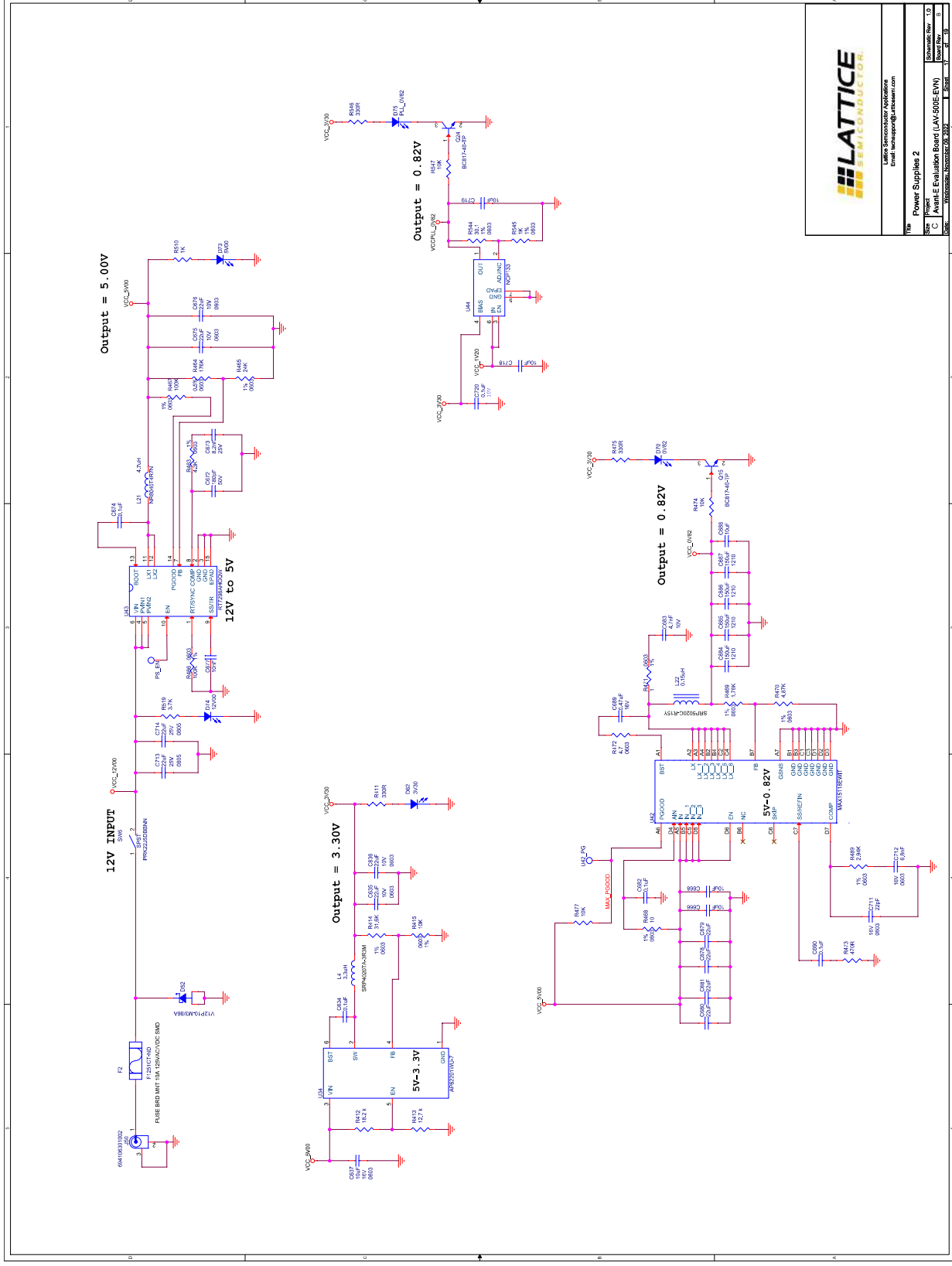

Figure A.16. Power Supplies 1

© 2022-2023 Lattice Semiconductor Corp. All Lattice trademarks, registered trademarks, patents, and disclaimers are as listed at www.latticesemi.com/legal. All other brand or product names are trademarks or registered trademarks of their respective holders. The specifications and information herein are subject to change without notice.



Lattice Semiconductor
Lattice Semiconductor Application
Email: technicalsupport@lattice.com

Rev	Description	Date
1.0	Initial Release	10/13/2022
1.1	Updated Schematic	10/13/2022
1.2	Updated Schematic	10/13/2022
1.3	Updated Schematic	10/13/2022

Power Supply 2
Avant-E Evaluation Board (LA1-500E-EVN)

Figure A.17. Power Supplies 2

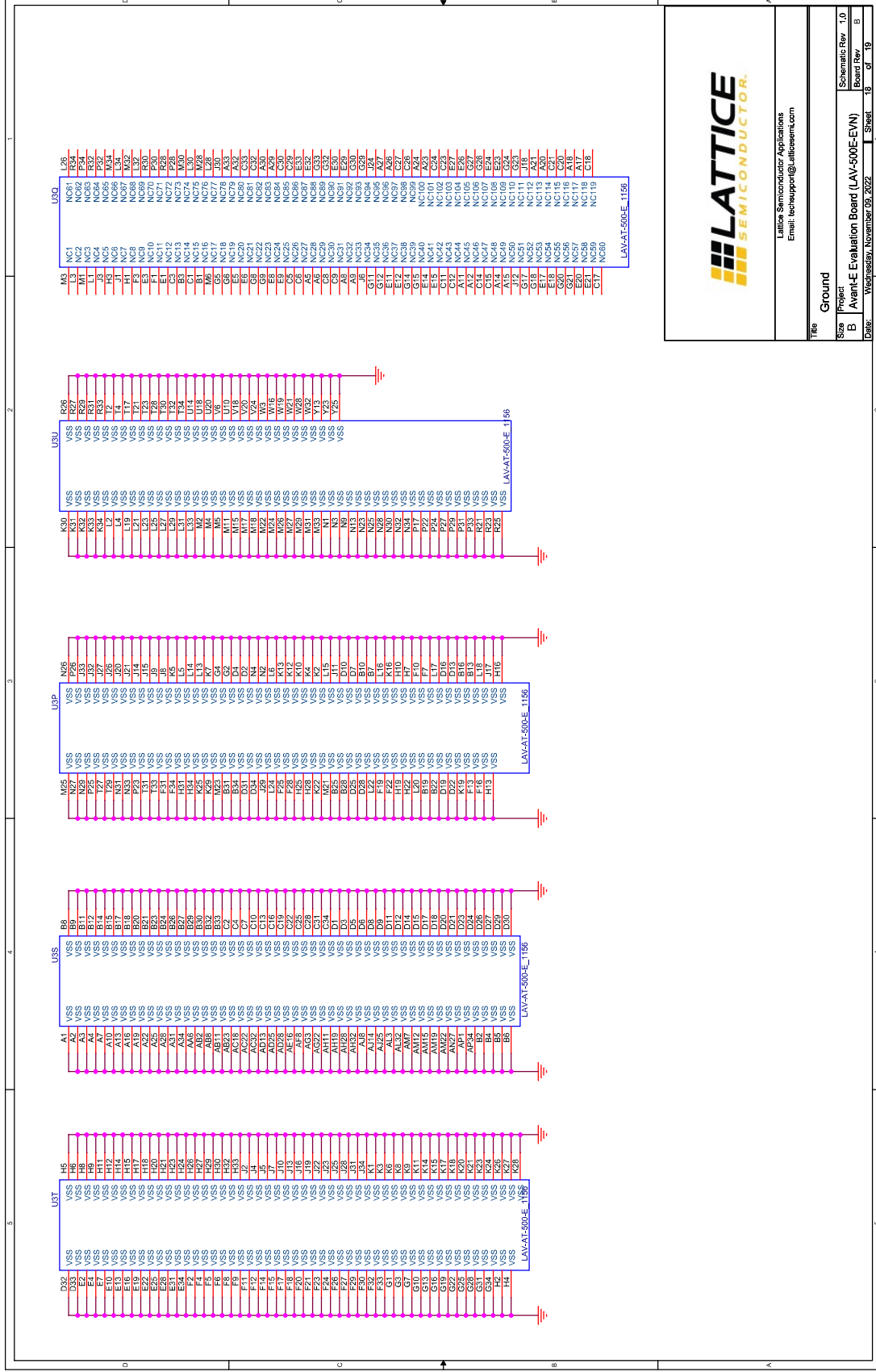

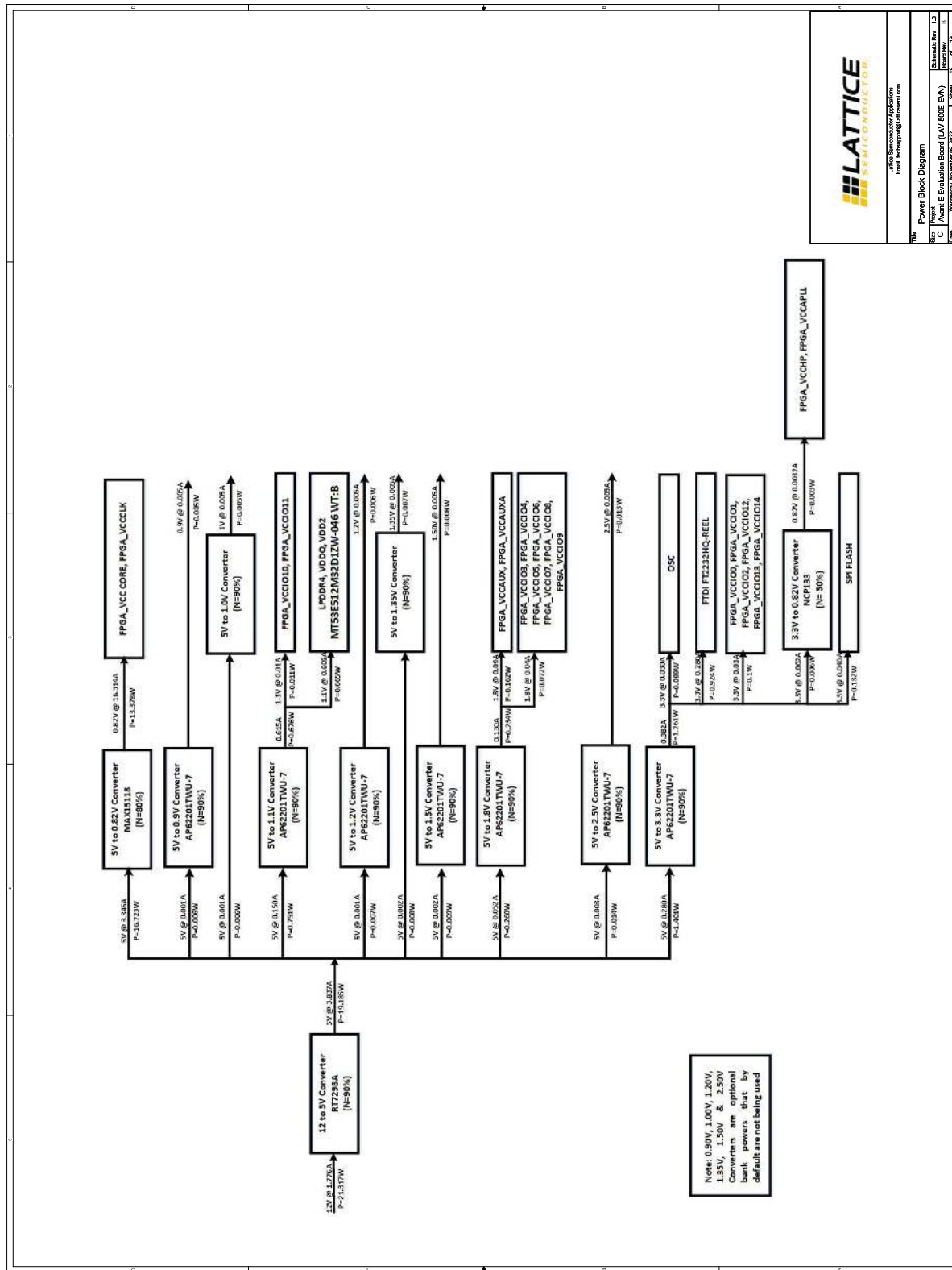

Figure A.19. Power Block Diagram

Appendix B. Avant Evaluation Board Bill of Materials

Item	Reference	Qty	Part	PCB Footprint	Comments	Part Number	Manufacturer	Description
1	VREFB1,B4_VREFA,B5_VREFB,6T,B8_VREFA, B9_VREFB,10T,VFMC1_3V30,VFMC2_3V30,ST	10	VTTVREF	TP_50	DNL	—	—	Test Points
2	C1,C2,C3,C4,C7,C8,C10,C11,C12,C13,C16,C20, C24,C31,C32,C38,C39,C40,C42,C43,C44,C46, C48,C56,C57,C58,C65,C66,C99,C100,C142, C143,C144,C145,C146,C147,C148,C149,C150, C151,C152,C164,C165,C166,C167,C171,C172, C173,C174,C175,C176,C177,C178,C289,C290, C291,C292,C398,C399,C400,C401,C404,C526, C527,C529,C530,C531,C532,C533,C535,C536, C537,C538,C539,C540,C541,C542,C544,C545, C546,C548,C561,C564,C579,C580,C584,C587, C588,C589,C590,C592,C593,C594,C596,C597, C598,C599,C600,C625,C629	100	0.1uF	C0201	—	GRM033R61E104KE14J	Murata Electronics	CAP CER 0.1UF 25V 10% X5R 0201
3	C5	1	4.7uF	C0603	—	ECJ-1VB0J475K	Panasonic Electronic Components	CAP CER 4.7UF 6.3V 10% X5R 0603
4	C6,C9	2	4.7uF	C0603	—	ECJ-1VB0J475K	Panasonic Electronic Components	CAP CER 4.7UF 6.3V 10% X5R 0603
5	C14	1	10uF	C0402	—	CL05A106MP8NUB8	Samsung Electro- Mechanics	CAP CER 10UF 10V X5R 0402
6	C15,C21,C22,C26,C27	5	0.1uF	C0201	—	GRM033R61E104KE14J	Murata Electronics	CAP CER 0.1UF 25V 10% X5R 0201
7	C17,C18	2	18pF	C0402	—	C0402C180K3GACTU	Kemet	CAP CER 18PF 25V 10% NP0 0402
8	C19,C33,C37,C41,C55,C64,C528,C534,C543, C547,C586,C591,C595,C614,C615,C616,C617, C618,C619	19	10uF	C0402	—	CL05A106MP8NUB8	Samsung Electro- Mechanics	CAP CER 10UF 10V X5R 0402
9	C23	1	0.1uF	C0201	—	GRM033R61E104KE14J	Murata Electronics	CAP CER 0.1UF 25V 10% X5R 0201
10	C25	1	1uF	C0603	—	TMK107B7105KA-T	Taiyo Yuden	CAP CER 1UF 25V 10% X7R 0603

Item	Reference	Qty	Part	PCB Footprint	Comments	Part Number	Manufacturer	Description
11	C36,C396,C397,C466,C469,C471,C474,C483,C485,C488,C510,C512,C525,C631	14	10uF	C0402	—	C1005X5R0J106M050BC	TDK Corporation	CAP CER 10UF 6.3V 20% X5R 0402
12	C45,C47,C558,C560	4	10uF	C1206	—	TMK316BJ106KL-T	Taiyo Yuden	CAP CER 10UF 25V X5R 1206
13	C49,C50,C51,C103,C104,C556,C557,C565,C622,C630,C678,C679,C680,C681	14	22uF	C0603	—	GRM188R61A226ME15D	Murata Electronics	CAP CER 22UF 10V X5R 0603
14	C52,C101,C559,C624	4	0.1nF	C0603	—	CC0603JRNPO9BN101	Yageo	CAP CER 100PF 50V C0G/NPO 0603
15	C53,C102,C562,C628	4	1uF	C0603	—	TMK107B7105KA-T	Taiyo Yuden	CAP CER 1UF 25V 10% X7R 0603
16	C54,C105,C563,C627	4	3.3nF	C0201	—	GRM033R71E332KA12D	Murata Electronics	CAP CER 3300PF 25V X7R 0201
17	C97,C98,C623,C626	4	10uF 25V 1206	C1206	—	TMK316BJ106KL-T	Taiyo Yuden	CAP CER 10UF 25V X5R 1206
18	C138,C139,C140,C163,C168,C169,C402,C403,C405,C620,C621	11	10uF	C0402	—	CL05A106MP8NUB8	Samsung Electro-Mechanics	CAP CER 10UF 10V X5R 0402
19	C287,C288,C293,C717	4	10nF	C0402	—	GRM155R60J103KA01D	Murata Electronics	CAP CER 10000PF 6.3V X5R 0402
20	C385,C632,C634,C638,C645,C649,C653,C657,C658,C662,C674,C682,C690	13	0.1uF	cap0402	—	GRM155R71H104KE14J	Murata Electronics	CAP CER 0.1UF 50V X7R 0402
21	C386,C387,C635,C636,C639,C640,C642,C643,C646,C647,C650,C651,C654,C655,C659,C660,C663,C664,C675,C676	20	22uF	C0603	—	CL10A226MP8NUNE	Samsung Electro-Mechanics	CAP CER 22UF 10V X5R 0603
22	C388,C641,C644,C648,C652,C656,C661,C665,C666,C668,C688,C718,C719	13	10uF	cap0805	—	C2012X5R1E106M085AC	TDK Corporation	CAP CER 10UF 25V X5R 0805
23	C465,C467,C468,C470,C472,C473,C475,C476,C477,C478,C479,C480,C481,C482,C484,C486,C487,C489,C490,C491,C492,C493,C494,C495,C496,C497,C498,C499,C500,C501,C502,C503,C504,C505,C506,C507,C508,C509,C511	39	0.1uF	C0201	—	GRM033R61A104KE15D	Murata Electronics	CAP CER 0.1UF 10V X5R 0201
24	C612,C613	2	22uF	C0402	—	CM05X5R226M06AH080	KYOCERA AVX	CAP CER 22UF 6.3V X5R 0402
25	C637	1	10uF	C0603	—	EMK107BBJ106MA-T	Taiyo Yuden	CAP CER 10UF 16V X5R 0603
26	C672	1	180pF	C0402	—	04025C181KAT2A	KYOCERA AVX	CAP CER 180PF 50V X7R 0402

Item	Reference	Qty	Part	PCB Footprint	Comments	Part Number	Manufacturer	Description
27	C673	1	8.2nF	C0402	—	GRM155R71E822KA01D	Murata Electronics	CAP CER 8200PF 25V X7R 0402
28	C677	1	10nF	C0402	—	CC0402KRX7R7BB103	YAGEO	CAP CER 10000PF 16V X7R 0402
29	C683	1	4.7nF	C0402	—	LMK1055D472KV-F	Taiyo Yuden	CAP CER 4700PF 10V 0402
30	C684,C685,C686,C687	4	150uF	C1210	—	CL32A157MQVNNNE	Samsung Electro-Mechanics	CAP CER 150UF 6.3V X5R 1210
31	C689	1	0.47uF	C0402	—	GMC04X5R474K25NT	CAL-CHIP ELECTRONICS, INC.	CAP CER 0.47UF 25V X5R 0402
32	C711	1	22pF	C0603	—	0603YA220KAT2A	KYOCERA AVX	CAP CER 22PF 16V NP0 0603
33	C712	1	6.8nF	C0603	—	0603YC682KAT2A	KYOCERA AVX	CAP CER 6800PF 16V X7R 0603
34	C713,C714	2	22uF	C0805	—	CC0805MKX5R8BB226	Yageo	CAP CER 22UF 25V X5R 0805
35	C720	1	0.1uF	C0402	—	GRM155R61A104KA01J	Murata Electronics	CAP CER 0.1UF 10V X5R 0402
36	TP_Y1,TP_AA1,TP_AM2,TP_AL2,TP_AH2,TP_AJ3,TP_Y5,TP_AA5,TP_AA10,INIT,DONE	11	TestPoint	TP50	DNL	—	—	Test Points
37	D1,D5,D6,D7,D8,D9,D10,D11,D12,D13	10	GREEN	APT1608	—	150060GS75000	Würth Elektronik	LED GREEN CLEAR 0603 SMD
38	D3	1	ESDR0502N-UDFN6	UDFN6_040	—	ESDR0502NMUTBG	onsemi	TVS DIODE 5.5VWWM 6UDFN
39	D4	1	RED	LED0603	—	150060RS75000	Würth Elektronik	LED RED CLEAR 0603 SMD
40	D22,D23,D24,D25,D26,D27,D28,D29	8	RED	LED0603	—	150060RS75000	Würth Elektronik	LED RED CLEAR 0603 SMD
41	D52	1	V12P10-M3/86A	TO-277A	—	V12P10-M3/86A	Vishay General Semiconductor - Diodes Division	DIODE SCHOTTKY 100V 12A TO277A
42	D60	1	LDT-N2804RI	display_1 2P-PTH	—	LDT-N2804RI	Lumex Opto/Components Inc.	DISPLAY 7SEG 0.28" TRP RED 12DIP

Item	Reference	Qty	Part	PCB Footprint	Comments	Part Number	Manufacturer	Description
43	D61	1	1V00	led_0603	—	SML-D12M8WT86	Rohm Semiconductor	LED GREEN DIFFUSED 0603 SMD
44	D62	1	3V30	led_0603	—	SML-D12M8WT86	Rohm Semiconductor	LED GREEN DIFFUSED 0603 SMD
45	D63	1	1V10	led_0603	—	SML-D12M8WT86	Rohm Semiconductor	LED GREEN DIFFUSED 0603 SMD
46	D64	1	1V80	led_0603	—	SML-D12M8WT86	Rohm Semiconductor	LED GREEN DIFFUSED 0603 SMD
47	D65	1	1V20	led_0603	—	SML-D12M8WT86	Rohm Semiconductor	LED GREEN DIFFUSED 0603 SMD
48	D66	1	2V50	led_0603	—	SML-D12M8WT86	Rohm Semiconductor	LED GREEN DIFFUSED 0603 SMD
49	D67	1	1V50	led_0603	—	SML-D12M8WT86	Rohm Semiconductor	LED GREEN DIFFUSED 0603 SMD
50	D68	1	0V90	led_0603	—	SML-D12M8WT86	Rohm Semiconductor	LED GREEN DIFFUSED 0603 SMD
51	D69	1	1V35	led_0603	—	SML-D12M8WT86	Rohm Semiconductor	LED GREEN DIFFUSED 0603 SMD
52	D70	1	0V82	led_0603	—	SML-D12M8WT86	Rohm Semiconductor	LED GREEN DIFFUSED 0603 SMD
53	D73	1	5V00	led_0603	—	SML-D12M8WT86	Rohm Semiconductor	LED GREEN DIFFUSED 0603 SMD
54	D74	1	12V00	led_0603	—	SML-D12M8WT86	Rohm Semiconductor	LED GREEN DIFFUSED 0603 SMD
55	D75	1	PLL_0V82	led_0603	—	SML-D12M8WT86	Rohm Semiconductor	LED GREEN DIFFUSED 0603 SMD
56	FB1,FB2,FB3,FB16,FB17	5	MPZ1005S 121CT000	FB0402	—	MPZ1005S121CT000	TDK Corporation	FERRITE BEAD 120 OHM 0402 1LN
57	FB4,FB24	2	FBMH2016 HM121NT	806	—	FBMH2016HM121NT	Taiyo Yuden	FERRITE BEAD 120 OHM 0806 1LN
58	FB15	1	BLM31KN1 21SNJL	FB1206	—	BLM31KN121SNJL	Murata Electronics	FERRITE BEAD 120 OHM 1206 1LN
59	FB22,FB25,FB26,FB27	4	BLM15AX6 01SNJID	402	—	BLM15AX601SNJID	Murata Electronics	FERRITE BEAD 600 OHM 0402 1LN
60	F1_ADJ,1V,F2_ADJ,5V,GND6,GND7,GND8, GND9,0V9,TP_AP10,TP_AL10,GND10,TP_AP11, TP_AL11,GND11,1V1,TP_AP12,TP_AN12,	52	T POINT R	TP	DNL	—	—	—

Item	Reference	Qty	Part	PCB Footprint	Comments	Part Number	Manufacturer	Description
61	TP_AK12,GND12,1V2,12V,TP_AP13,TP_AN13,TP_AM13,TP_AL13,TP_AK13,GND13,TP_AK14,TP_AH14,TP_AG14,GND14,TP_AK15,TP_AH15,TP_AG15,TP_AF15,TP_AE15,TP_AD15,GND15,1V5,TP_AK16,TP_AJ16,TP_AF16,1V8,2V5,3V3,0V82,F1_3V3AUX,F1_3V3,1V35,F2_3V3AUX,F2_3V3	1	F1251CT-ND	154010	—	0154010.DR	Littelfuse Inc.	FUSE BRD MNT 10A 125VAC/VDC SMD
62	GND1,GND2,GND3,GND4,GND5	5	TestPoint_Hole	TP	DNL	—	—	Square test point, 40mil inner diameter, 63mil outer diameter
63	JP1,JP2,JP3,JP4,JP5,JP6,JP7,JP8,JP17,JP43,JP44,JP45,JP46	13	JUMPER	Header_x2	—	—	—	Regular 100mil Header
64	JP12,JP13	2	JUMPER-DNI	Header_x2	DNL	—	—	Regular 100mil Header
65	JP25,JP28	2	3-PIN	HDR254M-1X3	Default : Pin 2 & 3	PEC03SAAN	Sullins Connector Solutions	CONN HEADER VERT 3POS 2.54MM
66	JP58,JP59,JP60,JP61,JP62,JP63,JP65	7	3-PIN	HDR254M-1X3	Default : Pin 1 & 2	PEC03SAAN	Sullins Connector Solutions	CONN HEADER VERT 3POS 2.54MM
67	JP64	1	3-PIN	HDR254M-1X3	—	PEC03SAAN	Sullins Connector Solutions	CONN HEADER VERT 3POS 2.54MM
68	JP26	1	Receptacle 20X2-DNI	HDR254-2X20_soc ket	DNL	—	—	—
69	JP31,JP32,JP33,JP34,JP35,JP36,JP37,JP38,JP39,JP40,JP41,JP42,JP47,JP48,JP49,JP50,JP51,JP52,JP66	19	J-2 Pin Jumper	Op1_2-Pin_TH	—	0022284020	Molex	CONN HEADER VERT 2POS 2.54MM
70	J1	1	Header 1x8	hdr_amp_87220_8_1x8_100	—	0022284081	Molex	CONN HEADER VERT 8POS 2.54MM
71	J2	1	USB_MINI_B	USB_MINI_B-1734035-2	—	1734035-2	TE Connectivity AMP Connectors	CONN RCPT USB2.0 MINI B SMD R/A

Item	Reference	Qty	Part	PCB Footprint	Comments	Part Number	Manufacturer	Description
72	J3,J10,J53	3	Header_2x7	Header_2x7	—	—	—	Regular 100mil Header
73	J6,J7	2	PMOD 2x6	PPPC062L JBN-RC	—	PPPC062LJBN-RC	Sullins Connector Solutions	CONN HDR 12POS 0.1 GOLD PCB R/A
74	J23,J57	2	Header_2x1	Header_2x1	—	—	—	Regular 100mil Header
75	J31,J32,J33	3	GND	TUR_TH	—	1573-2	Keystone Electronics	TERM TURRET SINGLE L=4.72MM TIN
76	J48,J54	2	ASP-134486-01	ASP-134486-01	—	ASP-134486-01	Samtec Inc.	CONN ARRAY RCPT 400POS SMD GOLD
77	J50	1	694106301002	694106301002	—	694106301002	Würth Elektronik	CONN PWR JACK 2.1X5.5MM SOLDER
78	J58,J59,J60,J61,J62,J63,J64,J65,J66,J67,J68,J69,J70,J71,J72,J73,J74,J75,J76,J77,J78,J79,J80	23	J-Header_2x1	Header_2x1	—	—	—	Regular 100mil Header
79	L1,L10,L13,L14	4	2.2uH SPM6530T-2R2M	SPM6530T-2R2M	—	SPM6530T-2R2M	TDK Corporation	FIXED IND 2.2UH 8.2A 19 MOHM SMD
80	L4,L5,L17	3	3.3uH	SRP4020T A-3R3M	—	SRP4020TA-3R3M	Bourns Inc.	FIXED IND 3.3UH 3.5A 76 MOHM SMD
81	L8,L15	2	1.5uH	SRP4020T A-1R5M	—	SRP4020TA-1R5M	Bourns Inc.	FIXED IND 1.5UH 4.5A 42 MOHM SMD
82	L16,L18,L20	3	2.2uH	SRP4020T A-2R2M	—	SRP4020TA-2R2M	Bourns Inc.	FIXED IND 2.2UH 4A 61 MOHM SMD
83	L19	1	1uH	SMD	—	SRP4020TA-1R0M	Bourns Inc.	FIXED IND 1UH 5A 27 MOHM SMD
84	L21	1	4.7uH	8mmx8mm	—	NR8040T4R7N	Taiyo Yuden	FIXED IND 4.7UH 4.1A 23.4MOHM SM
85	L22	1	0.15uH	SMD	—	SRP5020C-R15Y	Bourns Inc.	FIXED IND 150NH 18A 4 MOHM SMD
86	VFMC1_ADJ,VCCIO1,PB1,VFMC2_ADJ,VCCIO2,PB2,VCCIO3,PB3,VCCIO4,VCCAPLL4,VCCIO5,VCCIO6,VCCIO7,VCCAPLL7,VCCIO8,VCCIO9,VCCIO10,VCCAPLL10,VCCIO11,VCCIO12,VCCIO13,VCCIO14,U42_PG,VCCORE,VCCIO0,VCCHP,VCCCLK,VCCAUX,VCCAPLLW,PS_EN,	31	TestPoint_SMT	TPC32	DNL	—	—	—

Item	Reference	Qty	Part	PCB Footprint	Comments	Part Number	Manufacturer	Description
	PROGRAMIN							
87	Q1	1	MIMBT2222 ALT1G	MIMBT222 2ALT-1	—	MIMBT2222ALT1G	onsemi	TRANS NPN 40V 0.6A SOT23-3
88	Q2,Q3,Q4,Q7,Q8,Q9,Q10,Q11,Q12,Q13,Q14, Q15,Q16,Q17,Q18,Q19,Q20,Q21,Q22,Q23,Q24	21	BC817-40- TP	SOT23-3	—	BC817-40-TP	Micro Commercial Co	TRANS NPN 45V 0.8A SOT23
89	R1,R19	2	2.2K	R0603	—	RC0603FR-072K2L	Yageo	RES SMD 2.2K OHM 1% 1/10W 0603
90	R2,R3,R4,R21,R27,R30,R31,R32,R33,R34,R35, R36,R37,R47,R48	15	4.7K	R0603	—	CRCW06034K70FKEA	Vishay Dale	RES SMD 4.7K OHM 1% 1/10W 0603
91	R5,R11,R92,R317	4	2.2K	R0603	—	CRCW06032K20FKEA	Vishay Dale	RES SMD 2.2K OHM 1% 1/10W 0603
92	R6	1	22	R0402	—	ERJ-2RKF22R0X	Panasonic Electronic Components	RES SMD 22 OHM 1% 1/10W 0402
93	R7,R8,R9	3	0	R0402	—	RC0402FR-070RL	Yageo	RES 0 OHM JUMPER 1/16W 0402
94	R10	1	0-DNI	R0402	DNL	RC0402FR-070RL	Yageo	RES 0 OHM JUMPER 1/16W 0402
95	R12,R13,R14	3	10K	R0603	—	RMCF0603JT10K0	Stackpole Electronics Inc	RES 10K OHM 1/10W 5% 0603
96	R15	1	12K	R0603	—	RC0603FR-0712KL	Yageo	RES 12K OHM 1/10W 1% 0603 SMD
97	R16,R17	2	10K	R0603	—	RC0603FR-0710KL	Yageo	RES SMD 10K OHM 1% 1/10W 0603
98	R20,R408	2	0	R0402	—	RC0402FR-070RL	Yageo	RES 0 OHM JUMPER 1/16W 0402
99	R22,R26,R28	3	10k	R0603	—	RC0603FR-0710KL	Yageo	RES SMD 10K OHM 1% 1/10W 0603
100	R23,R29,R50,R51	4	100	R0402	—	ERJ-2RKF1000X	Panasonic	RES SMD 100 OHM 1% 1/10W 0402
101	R24,R25,R56,R57,R58,R59,R60,R61,R62,R63	10	1K	R0603	—	RC0603FR-071KL	Yageo	RES 1K OHM 1/10W 1% 0603 SMD
102	R38,R477	2	10K	R0402	—	CRCW040210K0JINED	Vishay Dale	RES SMD 10K OHM 5% 1/16W 0402
103	R39,R40,R41	3	10K_NP	402	DNL	ERJ-2GE1103X	Panasonic Electronic Components	RES SMD 10K OHM 5% 1/10W 0402

Item	Reference	Qty	Part	PCB Footprint	Comments	Part Number	Manufacturer	Description
104	R43, R44, R45, R46, R536	5	0	R0402	—	ERJ-2GE0R00X	Panasonic Electronic Components	RES SMD 0 OHM JUMPER 1/10W 0402
105	R55, R345	2	22	R0402	—	ERJ-2RKF22R0X	Panasonic Electronic Components	RES SMD 22 OHM 1% 1/10W 0402
106	R82, R298	2	0.01	R0402	—	PE0402FRF070R01L	Yageo	RES 0.01 OHM 1% 1/16W 0402
107	R83, R84, R217, R310, R327, R328	6	10k	R0603	—	RMCF0603JT10K0	Stackpole Electronics Inc	RES 10K OHM 1/10W 5% 0603
108	R85, R86, R87, R91, R314, R315, R316, R322, R543	9	4.7k	R0603	—	RC0603FR-074K7L	Yageo	RES 4.7K OHM 1% 1/10W 0603
109	R90, R321, R542	3	4.7k	R0603	—	CRCW06034K70FKEA	Vishay Dale	RES SMD 4.7K OHM 1% 1/10W 0603
110	R95, R251, R252, R307, R325, R326	6	1k	R0603	—	RC0603FR-071KL	Yageo	RES 1K OHM 1/10W 1% 0603 SMD
111	R96, R305	2	1K	402	—	RC0402FR-071KL	Yageo	RES 1K OHM 1% 1/16W 0402
112	R100, R306	2	301R	402	—	RC0402FR-07301RL	Yageo	RES 301 OHM 1% 1/16W 0402
113	R103, R104	2	0-DNI	R0603	DNL	RC0603JR-070RL	Yageo	RES 0 OHM JUMPER 1/10W 0603
114	R105, R107, R108	3	0-DNI	R0402	DNL	ERJ-2GE0R00X	Panasonic Electronic Components	RES SMD 0 OHM JUMPER 1/10W 0402
115	R106	1	22-DNI	R0402	DNL	ERJ-2RKF22R0X	Panasonic Electronic Components	RES SMD 22 OHM 1% 1/10W 0402
116	R111, R404	2	750 1%	R0402	—	ERJ-2RKF7500X	Panasonic Electronic Components	RES SMD 750 OHM 1% 1/10W 0402
117	R112, R403	2	422 1%	R0402	—	ERJ-2RKF4220X	Panasonic Electronic Components	RES SMD 422 OHM 1% 1/10W 0402
118	R137, R139, R140, R142, R143, R147, R153, R353, R370, R374, R378, R382, R385, R387, R391, R395	16	0.01	R0603	—	PF0603FRE7T0R01Z	Yageo	RES 0.01 OHM 1% 0.3W 0603
119	R152	1	0.001	R1206	—	PMR18EZPFV1L00	Rohm Semiconductor	1 mOhms ±1% 1W Chip Resistor 1206

Item	Reference	Qty	Part	PCB Footprint	Comments	Part Number	Manufacturer	Description
120	R154	1	0.1	603	—	RCWE0603R100FNEA	Vishay Dale	RES 0.1 OHM 1% 1/5W 0603
121	R155,R267,R539,R540,R541	5	1R	603	—	ERJ-3BQF1R0V	Panasonic Electronic Components	RES SMD 1 OHM 1% 1/4W 0603
122	R169,R339,R341,R343,R411,R417,R427,R433,R439,R444,R447,R453,R475,R521,R523,R524,R526,R528,R529,R532,R533,R546	22	330R	res0603	—	ERJ-3EKF3300V	Panasonic Electronic Components	RES SMD 330 OHM 1% 1/10W 0603
123	R171,R407	2	1.0k	R0402	—	RC0402FR-071KL	Yageo	RES 1K OHM 1% 1/16W 0402
124	R179,R180,R398	3	10k	R0402	—	RC0402FR-0710KL	Yageo	RES SMD 10K OHM 1% 1/16W 0402
125	R215,R216,R308,R309	4	0-DNI	R0603	DNL	RC0603JR-070RL	Yageo	RES 0 OHM JUMPER 1/10W 0603
126	R229,R416,R426,R432,R438,R443,R446,R452,R474,R520,R522,R525,R527,R530,R531,R534,R535,R547	18	10K	res0603	—	RC1608F103CS	Samsung Electro-Mechanics	RES SMD 10K OHM 1% 1/10W 0603
127	R231	1	2.61K	603	—	RC0603FR-072K61L	Yageo	RES 2.61K OHM 1% 1/10W 0603
128	R232,R415,R421,R424,R430,R436,R442,R451,R457	9	10K	603	—	RC0603FR-0710KL	Yageo	RES SMD 10K OHM 1% 1/10W 0603
129	R233,R412,R418,R422,R428,R434,R441,R448,R454	9	18.2 k	res0402	—	RT0402BRD0718K2L	Yageo	RES SMD 18.2KOHM 0.1% 1/16W 0402
130	R234,R413,R419,R423,R429,R435,R440,R449,R455	9	12.7 k	res0402	—	ERJ-2RKF1272X	Panasonic Electronic Components	RES SMD 12.7K OHM 1% 1/10W 0402
131	R249,R250,R323,R324	4	4.7k-DNI	R0603	DNL	ERJ-U03F4701V	Panasonic Electronic Components	RES 4.7K OHM 1% 1/10W 0603 SMD
132	R290,R294	2	240	R0201	—	RC0201FR-07240RL	Yageo	RES 240 OHM 1% 1/20W 0201
133	R291	1	240	R0402	—	RC0402JR-07240RL	Yageo	RES 240 OHM 5% 1/16W 0402
134	R292,R293	2	4.7k	R0402	—	RC0402FR-074K7L	Yageo	RES SMD 4.7K OHM 1% 1/16W 0402
135	R331,R332,R333,R334,R335,R336,R337,R338	8	53.6R	res0402	—	RC0402FR-0753R6L	Yageo	RES 53.6 OHM 1% 1/16W 0402

Item	Reference	Qty	Part	PCB Footprint	Comments	Part Number	Manufacturer	Description
136	R340,R342,R344	3	4.7K	res0603	—	RC0603JR-074K7L	Yageo	RES 4.7K OHM 5% 1/10W 0603
137	R399,R402	2	1.00k 1%	R0402	—	ERJ-U02F1001X	Panasonic Electronic Components	RES 1K OHM 1% 1/10W 0402 SMD
138	R400,R405	2	2.55k 1%	R0402	—	RK73H1ETTP2551F	KOA Speer Electronics, Inc.	RES 2.55K OHM 1% 1/10W 0402
139	R401,R406	2	1.02k 1%	R0402	—	RK73H1ETTP1021F	KOA Speer Electronics, Inc.	RES 1.02K OHM 1% 1/10W 0402
140	R414	1	31.6K	603	—	RC0603FR-0731K6L	Yageo	RES 31.6K OHM 1% 1/10W 0603
141	R420	1	3.83K	603	—	RC0603FR-073K83L	Yageo	RES 3.83K OHM 1% 1/10W 0603
142	R425	1	12.7K	603	—	RC0603FR-0712K7L	Yageo	RES 12.7K OHM 1% 1/10W 0603
143	R431	1	5.11K	603	—	RC0603FR-135K11L	Yageo	RES 5.11K OHM 1% 1/10W 0603
144	R437	1	21.5K	603	—	RC0603FR-0721K5L	Yageo	RES 21.5K OHM 1% 1/10W 0603
145	R445	1	8.87K	603	—	RC0603FR-078K87L	Yageo	RES 8.87K OHM 1% 1/10W 0603
146	R450	1	1.33K	603	—	RC0603FR-071K33L	Yageo	RES 1.33K OHM 1% 1/10W 0603
147	R456	1	6.98K	603	—	RC0603FR-076K98L	Yageo	RES 6.98K OHM 1% 1/10W 0603
148	R460,R461,R462	3	240	R0402	—	RC0402JR-07240RL	Yageo	RES 240 OHM 5% 1/16W 0402
149	R463	1	4.3K	603	—	RC0603FR-074K3L	Yageo	RES 4.3K OHM 1% 1/10W 0603
150	R464	1	176K	603	—	RT0603DRE07176KL	Yageo	RES SMD 176K OHM 0.5% 1/10W 0603
151	R465	1	24K	603	—	RC0603FR-0724KL	Yageo	RES 24K OHM 1% 1/10W 0603
152	R466,R467	2	100K	603	—	RC0603FR-07100KL	Yageo	RES 100K OHM 1% 1/10W 0603

Item	Reference	Qty	Part	PCB Footprint	Comments	Part Number	Manufacturer	Description
153	R468	1	10	603	—	RC0603FR-0710RL	Yageo	RES 10 OHM 1% 1/10W 0603
154	R469	1	1.78K	603	—	RC0603FR-071K78L	Yageo	RES SMD 1.78K OHM 1% 1/10W 0603
155	R470	1	4.87K	603	—	RC0603FR-074K87L	Yageo	RES 4.87K OHM 1% 1/10W 0603
156	R471	1	1	603	—	RC0603FR-071RL	Yageo	RES 1 OHM 1% 1/10W 0603
157	R472	1	4.7	603	—	RC0603JR-074R7L	Yageo	RES 4.7 OHM 5% 1/10W 0603
158	R473	1	470R	402	—	RC0402FR-07470RL	Yageo	RES 470 OHM 1% 1/16W 0402
159	R489	1	2.94K	603	—	RC0603FR-072K94L	Yageo	RES 2.94K OHM 1% 1/10W 0603
160	R490,R491	2	49.9R	R0201	—	RC0201FR-0749R9L	Yageo	RES 49.9 OHM 1% 1/20W 0201
161	R492,R493	2	NP	R0402	DNL	—	—	—
162	R510	1	1K	R0402	—	CRCW04021K00JNED	Vishay	RES SMD 1K OHM 5% 1/16W 0402
163	R519	1	3.7K	R0402	—	RN73H1ETTP3701F50	KOA Speer Electronics, Inc.	RES 3.7K OHM 1% 1/16W 0402
164	R537,R538,R548	3	0R	R0402	—	ERJ-2GE0R00X	Panasonic Electronic Components	RES SMD 0 OHM JUMPER 1/10W 0402
165	R544	1	30.1	603	—	RC0603FR-0730R1L	Yageo	RES 30.1 OHM 1% 1/10W 0603
166	R545	1	1K	603	—	RC0603FR-071KL	Yageo	RES 1K OHM 1% 1/10W 0603
167	SW1,SW2,SW4,SW5	4	430182043816	430182043816	—	430182043816	Wurth Electronik	SWITCH TACTILE SPST-NO 0.05A 12V
168	SW3	1	TDA DIP-8	TDA08HOS B1	—	TDA08HOSB1	C&K	SWITCH SLIDE DIP SPST 25MA 24V
169	SW6	1	SPST	SWR	—	PRK2Z15DBBNN	ZF Electronics	SWITCH ROCKER SPST 6A 125V

Item	Reference	Qty	Part	PCB Footprint	Comments	Part Number	Manufacturer	Description
170	U1	1	FT2232HL	tqfp64_0p5_12p2x12p2_h1p6	Customer Supplied	FT2232HL	FTDI	IC USB HS DUAL UART/FIFO 64-LQFP
171	U2	1	93LC56C-I/SN	so8_50_244	—	93LC56C-I/SN	Microchip Technology	IC EEPROM 2KBIT SPI 3MHZ 8SOIC
172	U3	1	LAV-AT-500-E_1156	LAV-AT-500-L_1156	Customer Supplied	—	—	—
173	U4	1	MX25L51245GZ2I-08G	8-WSON_M AC	—	MX25L51245GZ2I-08G	Macronix	IC FLASH 512MBIT SPI/QUAD 8WSON
174	U5	1	MT53E512M32D1ZW-046 WT:B	BGA_SDR AM_200	used PN from 305-PD-22-0022	MT53E512M32D1NP-046	Micron Technology Inc.	IC MEMORY DRAM 16G 512MX32 FBGA
175	U6,U10,U31,U32	4	BD9D321EFJ	HTSOP_8_BD9D321	Customer Supplied	BD9D321EFJ-E2	Rohm Semiconductor	IC REG BUCK ADJ 3A 8HTSOP-J
176	U17,U34,U35,U36,U37,U38,U39,U40,U41	9	AP62201WU-7	TSOT26_A P62201W U-7	—	AP62201WU-7	Diodes Incorporated	DCDC CONV HV BUCK TSOT26 T&R 3K
177	U42	1	MAX15118EWIT	BGA28N5 OP4X7_20 6X352X69 N	—	MAX15118EWI+T	Analog Devices Inc./Maxim Integrated	IC REG BUCK ADJUSTABLE 18A 28WLP
178	U43	1	RT7298AHGQW	14-WQFN	—	RT7298AHGQW	Richtek USA Inc.	IC REG BUCK ADJUSTABLE 6A 14WQFN
179	U44	1	NCP133	XDFFN6	—	NCP133AMXADJTCG	onsemi	IC REG LIN POS ADJ 500MA 6XDFN
180	X1	1	SXT324188B16-12.000M	xtal_4p_S XT324188B16_1200 OM	—	SXT324188B16-12.000MT	Suntu Electronics, Inc.	CRYSTAL 12.0000MHZ 18PF SMD
181	Y1	1	100 MHz	SMD6_AX 3HAF1	—	AX3HAF1-100.0000	Abracon LLC	XTAL OSC XO 100MHZ 3.3V HCSSL
182	Shunt for Headers	16	—	—	Load the shunts mentioned in the BoM and the	SNT-100-BK-T	Samtec Inc.	2 (1 x 2) Position Shunt Connector Black Open Top 0.100" (2.54mm) Tin

Item	Reference	Qty	Part	PCB Footprint	Comments	Part Number	Manufacturer	Description
183	Avant Evaluation Board RevB PCB	1	—	—	—	305-PD-22-0880	Pactron	—
					remaining are Bag & Tag			

References

Related documents available from your Lattice Semiconductor sales representative are listed below.

- [Programming Cables User Guide \(FPGA-UG-02042\)](#)
- [Lattice Avant sysCONFIG User Guide \(FPGA-TN-02299\)](#)
- [Lattice Avant Platform Data Sheet – Overview \(FPGA-DS-02107\)](#)
- [Lattice Avant Platform Data Sheet – Specifications \(FPGA-DS-02112\)](#)

Technical Support Assistance

Submit a technical support case through www.latticesemi.com/techsupport.

For frequently asked questions, refer to the Lattice Answer Database at www.latticesemi.com/Support/AnswerDatabase.

Revision History

Revision 1.0, January 2023

Section	Change Summary
All	Production release.
Introduction	Updated Figure 1.1. Top View of Avant-E Evaluation Board and Figure 1.2. Bottom View of Avant Evaluation Board reflecting the most recent revision of the Board.

Revision 0.80, December 2022

Section	Change Summary
All	Initial Preliminary release.



www.latticesemi.com